

# Grace technical specification



.mdd

**MDD has a leading position among manufacturers of office furniture with many awards that prove quality and continuously increase demand for its products.**

The realities of today's market require constant quality improvement at all levels of modern organization. This applies in particular to customer service, marketing, quality of products and also to quality of processes within the company.

Partnership relations among employees and with business partners form a base of economic growth and success of the company.

Constant investments in innovative machinery park, optimization of management systems and an expansion of production halls allow to minimize the lead times for the product of the highest quality.

**More than twenty years of experience in office furniture industry come with reference from a long list of companies and institutions to show their appreciation for an efficient and comprehensive service.**

**MDD is highly aware of the environment.**

Being located in the forest region with lake by its side, MDD takes the nature seriously and invests constantly in a modern and energy-efficient solutions to preserve the local life. Company puts emphasis on waste segregation and recycling. MDD has been awarded for the exceptional care and involvement in waste disposal. All materials used are environmentally friendly and enjoy a high 95 % rate of being recycled.



**General informations:**

**Warranty:**

MDD products - **5 years.**

Electrical components and fabric - **2 years.**

**Plate density:**

12 mm - 690 - 750 kg/m<sup>3</sup>

18 mm - 650 - 690 kg/m<sup>3</sup>

28 mm - 610 - 630 kg/m<sup>3</sup>

36 mm - 610 - 630 kg/m<sup>3</sup>

**Certificate - MFC:**



**Certificate - fabric:**



**Assembly:**

the product comes pre-assembled

**Packing:**

foam wrap

<p><b>Grace</b></p>	<p>Date of preparation 08.01.2020</p>	<p>The data contained in this document is valid in the day of its preparation. Change of the product, as long as it does not affect the basic features of it, does not require consistent updates of the document.</p>	<p>page 2/8 <b>general informations</b></p>
---------------------	---	--	---

## Grace

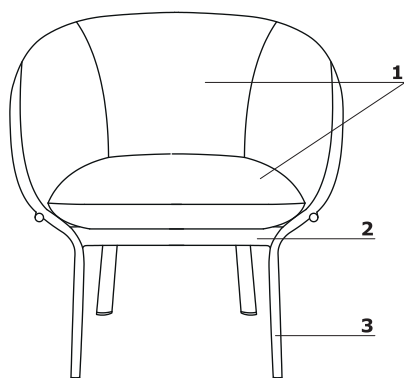

1. **Seat, backrest** - moulded foam, density of 52 kg/m<sup>3</sup>, upholstered
2. **Base** - oval-shaped profile 40 × 20 × 2 mm, tube Ø22 mm, wall thickness 2 mm, CNC-bent, powder coated
3. **Legs** - finished with material feet, colour: black

- max. load 120 kg

## Grace - tables

1. **Top** - MDF 19mm, natural veneer
2. **Frame** - oval-shaped profile 40 × 20 × 2 mm, tube Ø22 mm, wall thickness 2 mm, CNC-bent, powder coated

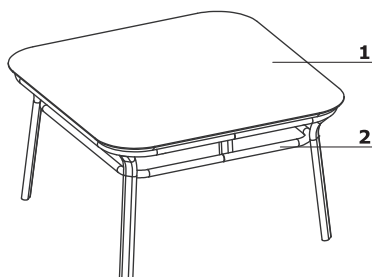

<b>Grace</b>	Date of preparation 08.01.2020	The data contained in this document is valid in the day of its preparation. Change of the product, as long as it does not affect the basic features of it, does not require consistent updates of the document.	page 3/8
			<b>technical specification</b>

### Dimensions

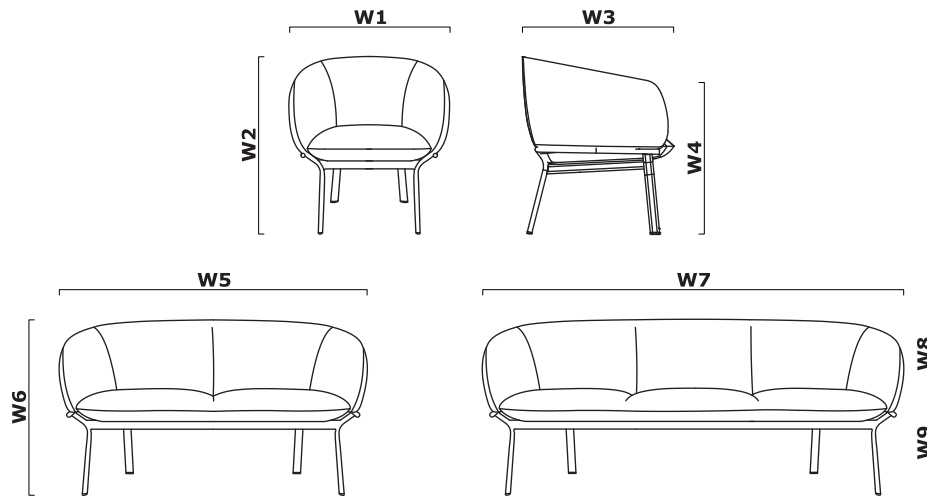

W1 - 700 | W2 - 760 | W3 - 650 | W4 - 600 | W5 - 1280 | W6 - 760 | W7 - 1860 | W8 - 340 | W9 - 420 |

### Dimensions - tables

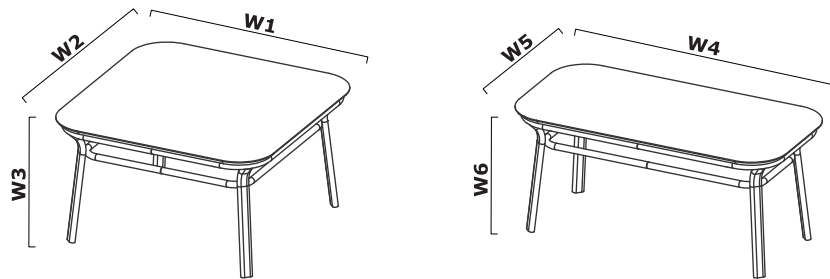

W1 - 800 | W2 - 800 | W3 - 450 | W4 - 1000 | W5 - 500 | W6 - 450 |

Grace \*



**GR01**  
700 / 650 / 760  
17 kg

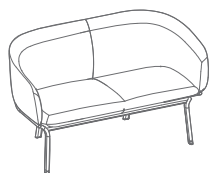

**GR02**  
1280 / 650 / 760  
30 kg

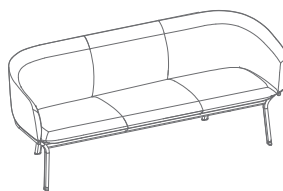

**GR03**  
1860 / 650 / 760  
45 kg

Tables \*

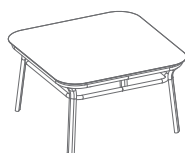

**GR01S**  
800 / 800 / 450  
20 kg

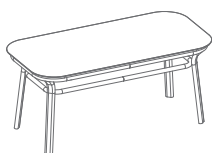

**GR02S**  
1000 / 500 / 450  
17 kg

\* dimensions expressed in millimeters: width x depth x height

<b>Grace</b>	Date of preparation 08.01.2020	The data contained in this document is valid in the day of its preparation. Change of the product, as long as it does not affect the basic features of it, does not require consistent updates of the document.	page 5/8
			<b>products</b>

Seat - GR01, GR02, GR03

Fabric Medley - second price group



**Technical data:**

**Material** polyester 100%

**Fabric weight** 510 g/lm (16.45 oz./lin.yd.)

**Abrasion resistance rubs** BS EN ISO 12947-2, 75,000 cykli Martindale

**Pilling resistance** scale 1-5, max. 5, EN ISO 12945-2 (4)

**Colour fastness to light** scale 1-8, max. 8, EN ISO 105-B02 (5-7)

**Colour fastness to rubbing** scale 1-5, max. 5, EN ISO 105x12 (wet/dry (4-5/4-5))

**Acoustic test sound absorption** ISO 354

**Flammability** BS EN 1021-1 (cigarette)  
BS 476 Part 7, Class 2  
Class Uno UNI 9174 - UNI 8457  
CA TB 117-2013  
ASTM E 84 Class I

Fabric Atlantic \* - second price group



**Technical data:**

**Material** polyester 100%

**Fabric weight** 530 g/lm (17.09 oz./lin.yd.)

**Abrasion resistance rubs** BS EN ISO 12947-2, 110,000 Martindale cycles

**Pilling resistance** scale 1-5, max. 5, EN ISO 12945-2 (4-5)

**Colour fastness to light** scale 1-8, max. 8, EN ISO 105-B02 (5-7)

**Colour fastness to rubbing** scale 1-5, max. 5, EN ISO 105x12 (wet/dry)

**Flammability** CA TB 117-2013  
ASTM E 84 Class I  
BS EN 1021-2 (match)  
BS EN 1021-1 (cigarette)

Fabric Vita - second price group



**Technical data:**

**Material** Surface: 98,5% PVC, 1,5% PU  
Substrate: 50% poliester, 50% Cotton

**Fabric weight** 850g/m2 ± 10% (1190G/lin. m ± 10%)

**Abrasion resistance rubs** BS EN ISO 5470-2, 100,000 Martindale cycles

**Colour fastness to light** 6 (ISO 105 - B02)

**Colour fastness to rubbing** wet: 4, dry: 4 (ISO 105 - X12)

**Flammability** BS EN 1021 - (cigarette)  
BS EN 1021 - 2 (match)  
BS 5852 - (Ignition Source 5)  
BS 7176 - (Medium Hazard)

**Flexes** BS EN ISO 7854 - Method B, 400.000 Flexing cycles

**Anti-microblal / Anti-fungal** AATCC 147

\* There is a possibility of ordering the product in full colour spectrum of Atlantic range, as per Gabriel's pattern book, within 8 weeks

### Fabric River - second price group



**Technical data:**

**Material** polyester 100%

**Fabric weight** 300g/m2 (+/- 5%)

**Abrasion resistance rubs** 100,000 Martindale cycles (EN ISO 12947-1,2)

**Pilling resistance** EN ISO 12945-2 (5)

**Colour fastness to light** 4 (EN ISO 105-B02)

**Colour fastness to rubbing** dry: 4-5, wet: 3 (EN ISO 105-x12)

**Flammability** BS 5852: Part 1, Ignition Source 0 (cigarette)  
BS 5852: Part 1, Ignition Source 1 (match)  
En1021 - 2

### Fabric Xtreme - third price group



**Technical data:**

**Material** 100% Trevira Clame (CS)  
100% Recykling (YS)  
Flame Retardant polyester.  
Non metallic dyestuffs.

**Fabric weight** 310 g/m2 ±5% (435g/lin.m ±5%)

**Abrasion resistance rubs** 60,000 Martindale cycles (CS)  
100,000 Martindale cycles (YS)

**Colour fastness to light** 6 (ISO 105 - B02)

**Colour fastness to rubbing** wet: 4, dry: 4 (ISO 105 - X12)

**Flammability** EN 1021 - 1 (cigarette),  
EN 1021 - 2 (match)  
BS 7176 Low Hazard,  
NF P92-507 M1, DIN 4102 B1,  
UNI 9175 Class 1 IM, UNI 8456,  
UNI 9174 & UNI 9177 Classe Uno,  
ÖNORM B 3825 & A 3800-1  
NF D 60-013

### Fabric Synergy - third price group

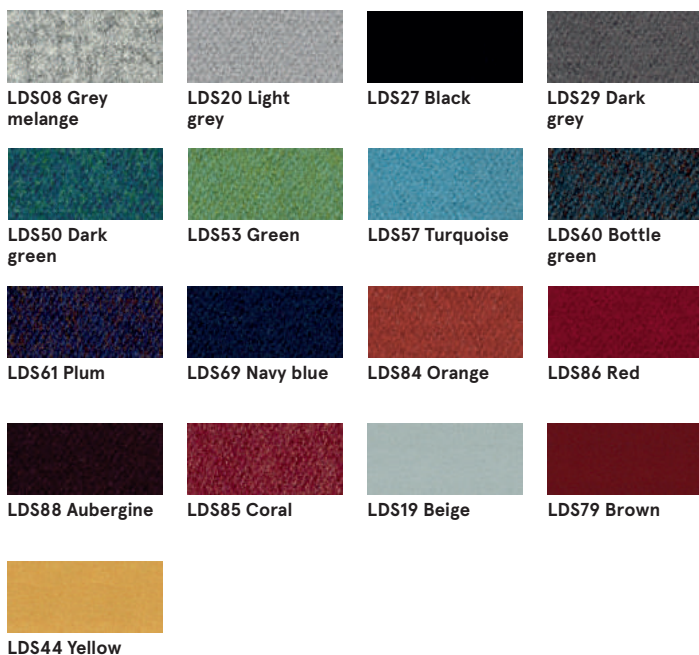

**Technical data:**

**Material** 95% Virgin Wool, 5% Poliamid

**Fabric weight** 400g/m2 ±5% (560 g/lin.m ±5%)

**Abrasion resistance rubs** Independently certified  
≥100,000 Martindale cycles

**Colour fastness to light** 5 (ISO 105 - B02)

**Colour fastness to rubbing** ISO 105 - X12 - wet: 4, dry: 4

**Flammability** EN 1021 - 1 (cigarette),  
EN 1021 - 2 (match),  
BS 7176 Low Hazard,  
UNI 9175 Classe 1 IM,  
ÖNORM B 3825 & A 3800-1

## Fabric Atlas – fourth price group



### Technical data:

**Material** 90% new wool, 10% nylon  
**Fabric weight** 286g/m2, 400g/lm  
**Abrasion resistance rubs** 100,000 cykli Martindale, EN ISO 12947  
**Colour fastness to light** ISO 105 B02: 6-7  
**Colour fastness to rubbing** ISO 105-X12:2001, (wet/dry) 4-5/4-5  
**Flammability** BS EN 1021-2 Match, BS EN 1021-1 Cigarette, BS 5 5852 Crib 5, BS 5852 ignition source 3, BS 5852 Part 1, NF D 60 013, UNI 9175 11M, US Cal. Bull. 117-2013

## Fabric Field2 – fourth price group



### Technical data:

**Material** 100% Trevira CS  
**Fabric weight** 321g/m2, 450g/lm  
**Abrasion resistance rubs** 100,000 cykli Martindale, EN ISO 12947  
**Colour fastness to light** ISO 105 B02: 5-7  
**Flammability** BS EN 1021-2 Match, BS EN 1021-1 Cigarette, BS 5 5852 Crib 5, DIN 4102 B1 FAR 25.853, UNI 9177 classe 1, US Cal. Bull. 117-2013

## Base – GR01, GR02, GR03, GR01S, GR02S



## Top – tables

