

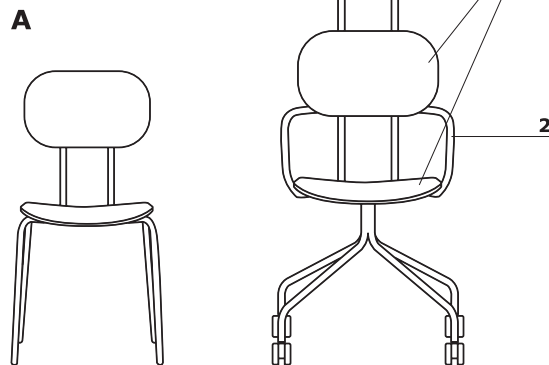

## Opis techniczny

- 1 Siedzisko, oparcie, zagłówek** - tapicerka (NEW1T, NEW2T), sklejka (NEW1W, NEW2W)
- 2 Podłokietniki** - metalowe (prawy + lewy) w kolorze stelaża; OPCJA Z DOPLATĄ - dla siedziska, oparcia NEW1T, NEW1W



A - NEW1T, NEW1W, B - NEW2T, NEW2W; max. obciążenie - 120 kg

## Podstawy

**1 Podstawa N01:**

- 4 nogi metalowe
- stelaż malowany proszkowo, wykonany z rury  $\varnothing 18$  mm, grubości ścianki 2 mm

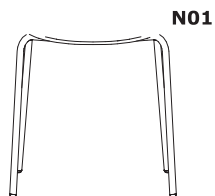
**2 Podstawa N07:**

- 4 - ro ramienna metalowa
- stelaż malowany proszkowo, wykonany z rury  $\varnothing 18$  mm, grubości ścianki 2 mm
- siedzisko obrotowe - 360°

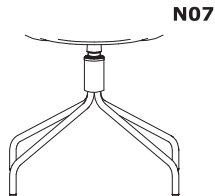
**3 Podstawa N03K:**

- 4 - ro ramienna metalowa
- kółka do powierzchni miękkich
- stelaż malowany proszkowo, wykonany z rury  $\varnothing 18$  mm, grubości ścianki 2 mm
- siedzisko nieobrotowe

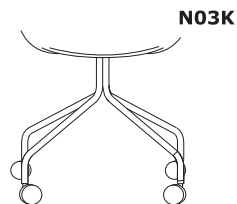
**4 Podstawa N04H:**

- hoker niski
- 4 nogi metalowe
- stelaż malowany proszkowo, wykonany z rury  $\varnothing 18$  mm, grubości ścianki 2 mm

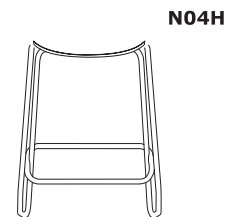
**5 Podstawa N05H:**



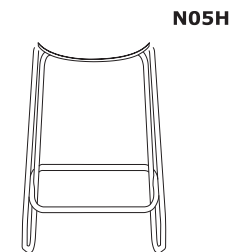

- hoker wysoki
- 4 nogi metalowe
- stelaż malowany proszkowo, wykonany z rury  $\varnothing 18$  mm, grubości ścianki 2 mm

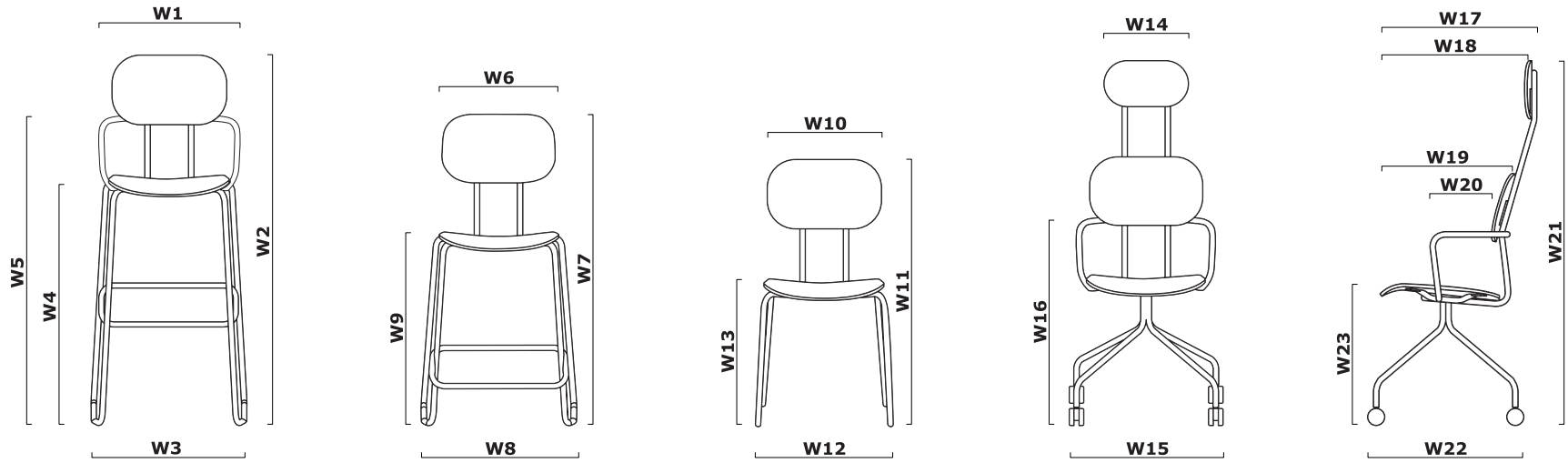









Wymiary (mm)





W1 - 535 | W2 - 1175 | W3 - 517 | W4 - 820 | W5 - 1025 | W6 - 420 | W7 - 995 | W8 - 517 | W9 - 640 | W10 - 390 | W11 - 817 | W12 - 458 | W13 - 462 | W14 - 330 | W15 - 550 |  
W16 - 670 | W17 - 603 | W18 - 543 | W19 - 420 | W20 - 250 | W21 - 1186 | W22 - 550 | W23 - 462 |

| Symbol: NEW1T   |             |        |      |           |               |                               |                 |  |
|---|-------------|--------|------|-----------|---------------|-------------------------------|-----------------|--|
|   | Podstawa    | Stelaż | III  | IV        | Podłokietniki | Kółka do powierzchni twardych | Waga Obj. Opak. | Informacje dodatkowe                       |
|   |             |        | Note | Alcantara |               |                               |                 |  |
|  | <b>N01</b>  | metal  |      |           |               |                               | 7<br>0,299      |  |
|   |             | chrom  |      |           |               |                               | 1               |  |
|  | <b>N07</b>  | metal  |      |           |               |                               | 7<br>0,299      |  |
|   |             | chrom  |      |           |               |                               | 1               |  |
|  | <b>N03K</b> | metal  |      |           |               |                               | 7<br>0,299      |  |
|   |             | chrom  |      |           |               |                               | 1               |  |
|  | <b>N04H</b> | metal  |      |           |               |                               | 8<br>0,349      | tylko dla siedziska, oparcia NEW1T i NEW1W |
|   |             | chrom  |      |           |               |                               | 1               |  |
|  | <b>N05H</b> | metal  |      |           |               |                               | 9<br>0,406      |  |
|   |             | chrom  |      |           |               |                               | 1               |  |

| Symbol: NEW2T   |             |        |      |           |               |                               |                 |                      |
|---|-------------|--------|------|-----------|---------------|-------------------------------|-----------------|----------------------|
|   | Podstawa    | Stelaż | III  | IV        | Podłokietniki | Kółka do powierzchni twardych | Waga Obj. Opak. | Informacje dodatkowe |
|   |             |        | Note | Alcantara |               |                               |                 |                      |
|  | <b>N01</b>  | metal  |      |           |               |                               | 9<br>0,424<br>1 |                      |
|   |             | chrom  |      |           |               |                               |                 |                      |
|  | <b>N07</b>  | metal  |      |           |               |                               | 9<br>0,424<br>1 |                      |
|   |             | chrom  |      |           |               |                               |                 |                      |
|  | <b>N03K</b> | metal  |      |           |               |                               | 9<br>0,424<br>1 |                      |
|   |             | chrom  |      |           |               |                               |                 |                      |

| Symbol: <b>NEW1W</b>  |             |        |         |               |                               |                 |  |
|---|-------------|--------|---------|---------------|-------------------------------|-----------------|--|
|   | Podstawa    | Stelaż | Sklejka | Podłokietniki | Kółka do powierzchni twardych | Waga Obj. Opak. | Informacje dodatkowe                       |
|  | <b>N01</b>  | metal  |         |               |                               | 7<br>0,299<br>1 | tylko dla siedziska, oparcia NEW1T i NEW1W |
|   |             | chrom  |         |               |                               |                 |  |
|  | <b>N07</b>  | metal  |         |               |                               | 7<br>0,299<br>1 |  |
|   |             | chrom  |         |               |                               |                 |  |
|  | <b>N03K</b> | metal  |         |               |                               | 7<br>0,299<br>1 |  |
|   |             | chrom  |         |               |                               |                 |  |
|  | <b>N04H</b> | metal  |         |               |                               | 8<br>0,349<br>1 |  |
|   |             | chrom  |         |               |                               |                 |  |
|  | <b>N05H</b> | metal  |         |               |                               | 9<br>0,406<br>1 |  |
|   |             | chrom  |         |               |                               |                 |  |

| Symbol: <b>NEW2W</b>  |             |        |         |               |                               |                 |                      |
|---|-------------|--------|---------|---------------|-------------------------------|-----------------|----------------------|
|   | Podstawa    | Stelaż | Sklejka | Podłokietniki | Kółka do powierzchni twardych | Waga Obj. Opak. | Informacje dodatkowe |
|   |             |        |         |               |                               |                 |                      |
|  | <b>N01</b>  | metal  |         |               |                               | 9<br>0,424      |                      |
|   |             | chrom  |         |               |                               | 1               |                      |
|  | <b>N07</b>  | metal  |         |               |                               | 9<br>0,424      |                      |
|   |             | chrom  |         |               |                               | 1               |                      |
|  | <b>N03K</b> | metal  |         |               |                               | 9<br>0,424      |                      |
|   |             | chrom  |         |               |                               | 1               |                      |