

**PEDRALI®**

# MODUS MDB



DESIGN:  
PEDRALI R&D

Modus, back to back unit, is a functional bench that help to optimize the spaces. It can be placed in the center of the room or aside a wall.

INFORMATION REQUEST



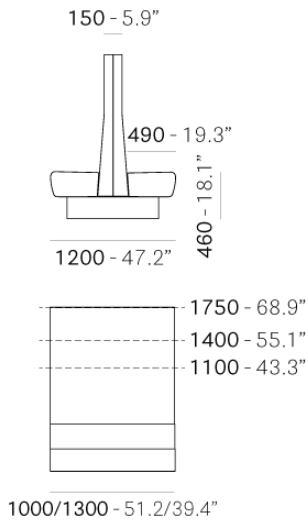

FRAME FINISHES

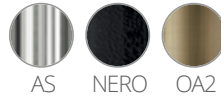

FABRICS (VIEW FINISHES AND MATERIALS)

FINISHES AND MATERIALS

Couple sideboard (art.MD4), Backside panel (art.MD5)

**PEDRALI®**

# MODUS MDAB



DESIGN:  
PEDRALI R&D

Modus è una innovativa collezione di sedute modulari imbottite, progettata per creare varie configurazioni d'arredo, garantendo un'assoluta flessibilità in fase di assemblaggio e installazione. Modulo angolare bifacciale, con seduta e schienale imbottiti con uno schiumato poliuretano ignifugo; rivestito in pelle, finta pelle o tessuto, può avere una finitura liscia, con bottoni, capitoné, con cuciture orizzontali o verticali. Altezze 110, 140, 175 cm.

Disponibile come accessorio un pannello posteriore in laminato o imbottito

INFORMATION REQUEST



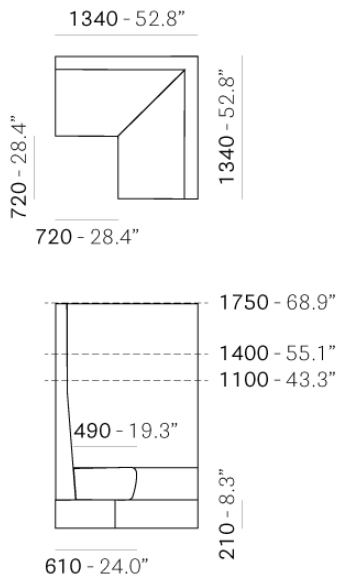

DIMENSIONI

FRAME FINISHES

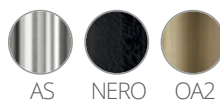

FABRICS (VIEW FINISHES AND MATERIALS)

FINISHES AND MATERIALS

# PEDRALI®

## MODUS MDA



DESIGN:  
PEDRALI R&D

Modus, Corner unit at 90 degrees, allows to create multiple configurations of seats. Upholstered Backrest can be in different height cm.110,cm.175, cm.240.

INFORMATION REQUEST



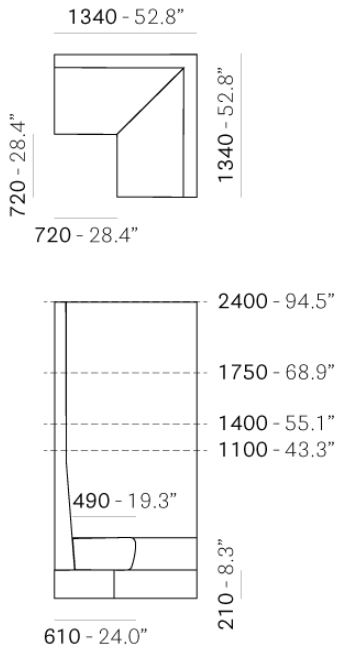

FRAME FINISHES

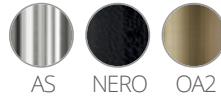

FABRICS (VIEW FINISHES AND MATERIALS)

FINISHES AND MATERIALS

Couple sideboard (art.MD4), Backside panel (art.MD5)

# Modus

**PEDRALI**  
THE ITALIAN ESSENCE

MDL\_110 - MDL\_110\_L100 - MDL\_140 - MDL\_140\_L100  
MDL\_175 - MDL\_175\_H100 - MDL\_240 - MDL\_240\_L100

100% MADE IN ITALY

DESIGN  
Pedrali R&D

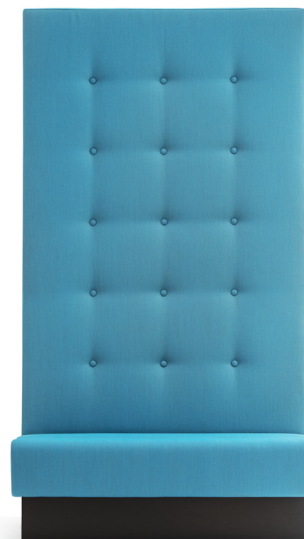
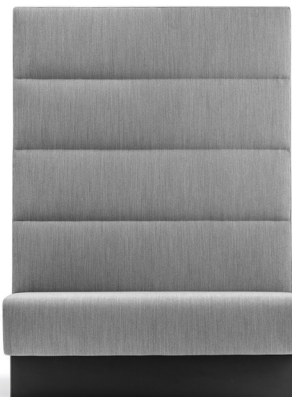
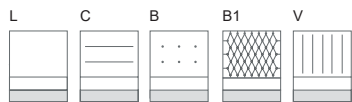

**Modus bench linear unit, to be laid against a wall, seat and backrest upholstered with fire-retardant polyurethane foam, extruded aluminium baseboard**  
Panca Modus modulo lineare per appoggio a parete, seduta e schienale imbottiti con schiumato poliuretano ignifugo e zoccolo in estruso di alluminio / Modus Bank linear, zur Wand-Befestigung, Sitz und Rücken gepolstert mit feuerfestem Polyurethan-Schaum und Sockelleisten aus extrudiertem Aluminium / Module linéaire Modus à mur, assise et dossier rembourrés en mousse de polyuréthane ignifuge et socle en aluminium extrudé / Módulo lineal de banco Modus para soporte de pared, asiento y respaldo tapizado con espuma de poliuretano ignífuga y zócalo de aluminio extruido

## • MDL\_110

mm - in

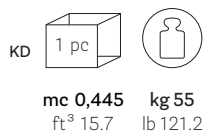
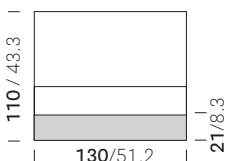
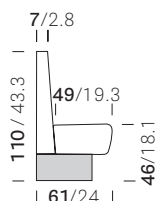

## • MDL\_110\_L100

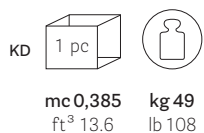
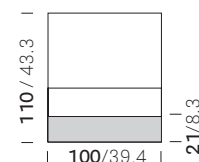
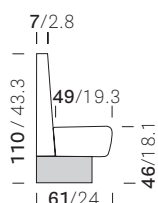

## • MDL\_140

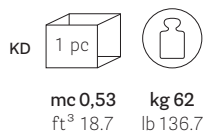
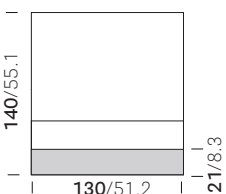
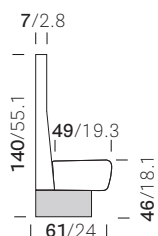

## • MDL\_140\_L100

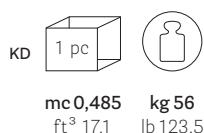
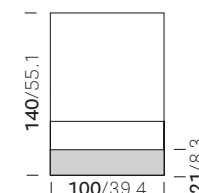
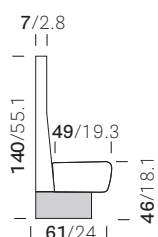

Reproduction of this document is strictly prohibited without prior written authorisation from Pedrali SpA. Sizes, weights and finishes may change without previous notice. È vietata la riproduzione del seguente documento senza previa autorizzazione scritta da parte di Pedrali SpA. Dimensioni, pesi e finiture possono variare senza alcun preavviso.

# Modus

**PEDRALI**  
THE ITALIAN ESSENCE

MDL\_110 - MDL\_110\_L100 - MDL\_140 - MDL\_140\_L100  
MDL\_175 - MDL\_175\_H100 - MDL\_240 - MDL\_240\_L100



100% MADE IN ITALY

DESIGN  
Pedrali R&D

## • MDL\_175

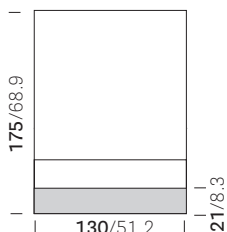
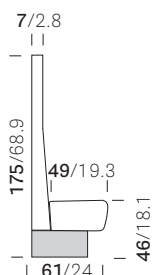

mm - in



KD  1 pc   
mc **0,6** kg **77**  
ft<sup>3</sup> 21.2 lb 179.8

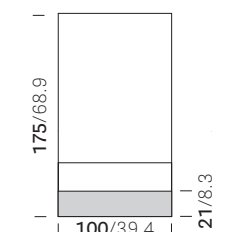
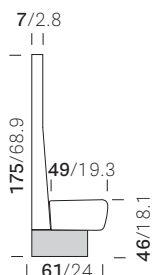

## • MDL\_175\_L100



KD  1 pc   
mc **0,485** kg **71**  
ft<sup>3</sup> 17.1 lb 156.5

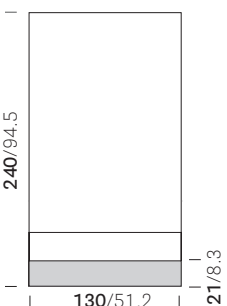
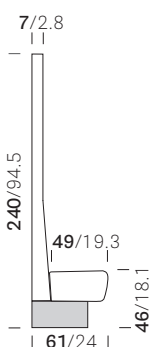

## • MDL\_240

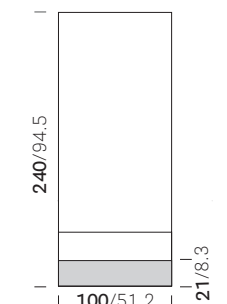
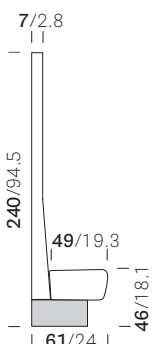

KD  1 pc   
mc **0,73** kg **90**  
ft<sup>3</sup> 25.8 lb 198.4

## • MDL\_240\_L100



KD  1 pc   
mc **0,69** kg **84**  
ft<sup>3</sup> 24.4 lb 185.2



Reproduction of this document is strictly prohibited without prior written authorisation from Pedrali SpA. Sizes, weights and finishes may change without previous notice.  
È vietata la riproduzione del seguente documento senza previa autorizzazione scritta da parte di Pedrali SpA. Dimensioni, pesi e finiture possono variare senza alcun preavviso.



MDL\_110 - MDL\_110\_L100 - MDL\_140 - MDL\_140\_L100  
MDL\_175 - MDL\_175\_H100 - MDL\_240 - MDL\_240\_L100

100% MADE IN ITALY

DESIGN  
Pedrali R&D

<p><b>MATERIALS</b> Materiali Materialien Matériaux Materiales</p>	<ul style="list-style-type: none"> <li> <p><b>FRAME - TELAIO - STRUKTUR - STRUCTURE - ARMAZÓN</b> <b>Steel structure, black powder coated with adjustable feet</b> Struttura in acciaio, verniciato nero con piedini regolabili / Struktur aus Stahl, pulverbeschichtet schwarz mit Verstellgleitern / Structure en acier, époxy noir avec vérous réglables / Armazón de acero, barnizado negro con tacos reguladores</p> </li> <li> <p><b>BACKREST - SCHIENALE - RÜCKENLEHNE - DOSSIER - RESPALDO</b> <b>Wooden structure with steel reinforcement bars, upholstered with flexible polyurethane (density 26 kg/m<sup>3</sup>), fire-retardant (certified 11M, Crib 5)</b> Struttura in legno con rinforzi in acciaio, imbottito in poliuretano flessibile (densità 26 kg/m<sup>3</sup>), ignifugo (classe 11M, Crib 5), rivestita in tessuto / Struktur aus Holz, gepolstert mit flexiblem Polyurethan (Dichte 26kg/m<sup>3</sup>), feuerfest (Klasse 1 M, Crib 5), mit Stoff überzogen / Structure en bois avec armatures en acier, rembourré en polyuréthane souple (densité 26 kg / m<sup>3</sup>), ignifuge (classe 11M, Crib 5), recouverts de tissu / Estructura de madera con refuerzos de acero, tapizada con poliuretano flexible (densidad 26 kg/m<sup>3</sup>), ignifugo (clase 11M, Cuna 5), forrada de tela.</p> <p><b>FRONT BACKREST FINISH - FINITURA SCHIENALE ANTERIORE - AUSFÜHRUNG DER RÜCKENLEHNE-VORDERSEITE - FINITION PANNEAU ARRIÈRE - ACABADO RESPALDO DELANTERO</b> <b>Upholstering in categories A - C - D - E - G - H - N - smooth (L), with horizontal stitches (C), with decorative buttons (B), capitoné (B1), with vertical stitches (V)</b> Rivestimento in cat. A - C - D - E - G - H - N - liscio (L), con cuciture orizzontali (C), con bottoni (B), capitoné (B1) con cuciture verticali (V); / Bezug Cat A-C-D-E-G-H-N - glatt (L), mit horizontalen Nähten (C), geknöpft (B), capitoné (B1), mit vertikalen Nähten (V) / Ganissage en cat. A - C - D - E - G - H - N - lis (L), avec coutures horizontales (C), avec boutons (B), capitoné (B1), avec coutures verticales (V) / Tapizado en cat. A - C - D - E - G - H - N - liso (L), con costuras horizontales (C), con botones (B), capitoné (B1), con costuras verticales (V)</p> </li> <li> <p><b>SEAT - SEDILE - SITZFLÄCHE - ASSISE - ASIENTO</b> <b>Wooden structure with steel reinforcement bars, upholstered with flexible polyurethane (density 26 kg/m<sup>3</sup>), fire-retardant (certified 11M, Crib 5)</b> Struttura in legno con rinforzi in acciaio, imbottito in poliuretano flessibile (densità 60 kg/m<sup>3</sup>), ignifugo (classe 11M, Crib 5), rivestita in tessuto / Struktur aus Holz, gepolstert mit flexiblem Polyurethan (Dichte 60 kg/m<sup>3</sup>), feuerfest (Klasse 1 M, Crib 5), mit Stoff überzogen / Structure en bois avec armatures en acier, rembourré en polyuréthane souple (densité 60 kg / m<sup>3</sup>), ignifuge (classe 11M, Crib 5), recouverts de tissu / Estructura de madera con refuerzos de acero, tapizada con poliuretano flexible (densidad 60 kg/m<sup>3</sup>), ignifugo (clase 11M, Cuna 5), forrada de tela.</p> </li> <li> <p><b>SEAT FINISH - FINITURA SEDILE - AUSFÜHRUNG DER SITZFLÄCHE - FINITION ASSISE - ACABADO ASIENTO</b> <b>Upholstering in categories A - C - D - E - G - H - N - with horizontal stitching (standard version) or smooth (for capitoné version)</b> Rivestimento in cat. A - C - D - E - G - H - N - con cucitura orizzontale (standard), liscio (per versione capitoné) / Bezogen mit Stoff Cat A-C-D-E-G-H-N - mit horizontalen Nähten (Standard), glatt (für Version capitoné) / Ganissage en cat. A - C - D - E - G - H - N - avec couture horizontale (standard), lis (pour version capitoné) / Tapizado en cat. A - C - D - E - G - H - N - con costuras horizontales (estándar), liso (en la versión capitoné)</p> </li> <li> <p><b>BASEBOARD - ZOCCOLO - SOCKELLEISTEN - SOCLE - ZÓCALO</b> <b>Anodized extruded aluminium, matt black, satinized or antique brass finish, with transparent gasket</b> Estruso di alluminio, anodizzato nero opaco, satinato o ottone anticato con guarnizione trasparente / Extrudiertes Aluminium, anodisiert, schwarz matt, satiniert oder antikes Messing mit durchsichtigen Dichtungen / Extrudé d'aluminium, anodisé noir mat, satiné, ou finition laiton vieilli avec garniture transparente / Aluminio extruído, anodizado negro mate, satinado, o latón envejecido con con guarnición transparente</p> <div style="display: flex; justify-content: space-around; align-items: center;">    </div> <p style="text-align: center;">AS      NE      OA2</p> </li> </ul>
<p><b>ACCESSORIES</b> Accessori Zubehörteile Accessoires Accesorios</p>	<p><b>code MD5</b> <b>Backside laminate panel</b> Pannello di copertura posteriore in laminato / Paneel aus Laminat für Rückseite / Panneau de couverture postérieur en stratifié / Panel trasero de laminado</p>
<p><b>REGULATIONS AND CERTIFICATES</b> Normative e Certificazioni Bestimmungen und Zertifikat Normatives et certifications Normativas y certificados</p>	<p><b>Conforming to: seat and back static load test EN 1728 - EN 16139, level L2 - extreme</b> Conforme alla norma: carico statico sul sedile-schienale EN 1728 - EN 16139, livello L2 - estremo</p> <p><b>Conforming to: combined seat and back fatigue test, 200.000 cycles EN 1728 - EN 16139, level L2 - extreme</b> Conforme alla norma: resistenza a fatica del sedile-schienale, 200.000 cicli EN 1728 - EN 16139, livello L2 - estremo</p> <p><b>Ministerial type approval «serie Modus» Class 1 IM (Cat. H20÷H36 - H100÷H108)</b> Omologazione Ministeriale «serie Modus» Classe 1 IM (Cat. H20÷H36 - H100÷H108) / Ministerial Zulassung «Serie Modus» Klasse 1 IM (Cat. H20÷H36 - H100÷H108) / Homologation Ministérielle «Serie Modus» Classe 1 IM (Cat. H20÷H36 - H100÷H108) / Homologación Ministerial «Serie Modus» Clase 1 IM (Cat. H20÷H36 - H100÷H108)</p> <p><b>Smouldering cigarette test EN 1021-1:2006</b> Sigaretta in combustione lenta su mobili imbottiti EN 1021-1:2006</p> <p><b>87% demountable product - 19% recyclable material *</b> Prodotto 87% disassemblabile - 19% materiali riciclabili / Produkt 87% demontierbar - 19% Material recyclingfähig / Produit 87% démontable - 19% recyclable / Producto 87% desmontable - 19% materiales reciclables</p> <p style="text-align: right;"><small>* Percentages referred to MDL_140 Percentuali riferite al MDL_140</small></p>

Reproduction of this document is strictly prohibited without prior written authorisation from Pedrali SpA. Sizes, weights and finishes may change without previous notice. È vietata la riproduzione del seguente documento senza previa autorizzazione scritta da parte di Pedrali SpA. Dimensioni, pesi e finiture possono variare senza alcun preavviso.