

1 grupa cenowa  
1. Preisgruppe  
1<sup>st</sup> price group



BD 005



BD 012



BD 078



BD 048



BD 021



BD 033



BD 023



BD 011



BD 004



BD 003



BD 071



BD 006



BD 008



BD 036

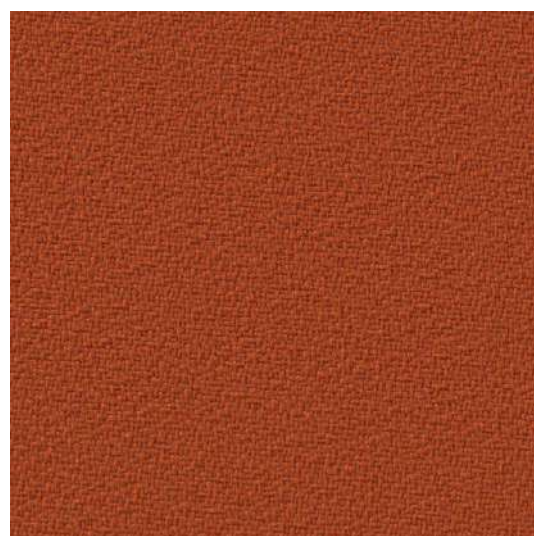

BD 013

**PL****Skład**

100% Poliester

**Waga**

250 g/m<sup>2</sup> ± 5%

**Szerokość rolki**

140 cm

**Odporność na ścieranie**

150 000 cykli Martindale  
(UNI EN ISO 12947/2):2017

**Pilling**

5 (UNI EN ISO 12945/2):2002

**Odporność na światło**

7 (EN ISO 105-B02):2014

**Certyfikaty trudnopalności**

- BS EN 1021-1:2014
- BS EN 1021-2:2014
- BS 5852:2006 (CRIB 5)
- BS 7176:2007 (Medium Hazard)
- UNI 9175 (1987) 1 IM

**DE****Zusammensetzung**

100% Polyester

**Gewicht**

250 g/m<sup>2</sup> ± 5%

**Rollenbreite**

140 cm

**Scheuerfestigkeit**

150 000 Zyklen Martindale  
(UNI EN ISO 12947/2):2017

**Pilling**

5 (UNI EN ISO 12945/2):2002

**Lichtechtheit**

7 (EN ISO 105-B02):2014

**Feuersicherung**

- BS EN 1021-1:2014
- BS EN 1021-2:2014
- BS 5852:2006 (CRIB 5)
- BS 7176:2007 (Medium Hazard)
- UNI 9175 (1987) 1 IM

**EN****Composition**

100% Polyester

**Weight**

250 g/m<sup>2</sup> ± 5%

**Roll width**

140 cm

**Abrasion Resistance**

150 000 Martindale cycles  
(UNI EN ISO 12947/2):2017

**Pilling**

5 (UNI EN ISO 12945/2):2002

**Light Fastness**

7 (EN ISO 105-B02):2014

**Flammability**

- BS EN 1021-1:2014
- BS EN 1021-2:2014
- BS 5852:2006 (CRIB 5)
- BS 7176:2007 (Medium Hazard)
- UNI 9175 (1987) 1 IM





FN 019



FN 020



FN 018

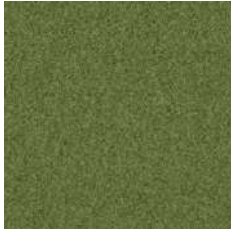

FN 017



FN 016



FN 015



FN 014



FN 013

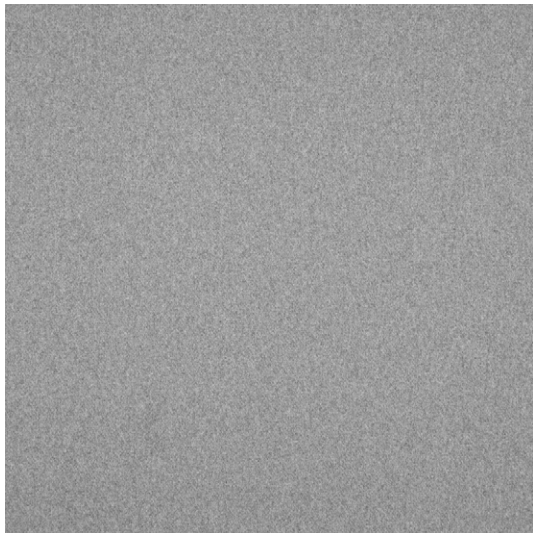

FN 005

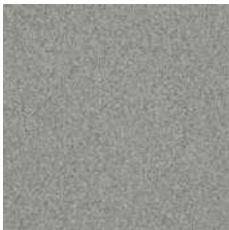

FN 001



FN 002



FN 004

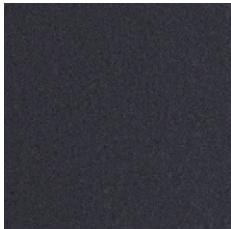

FN 012

**PL**

**Skład**  
100% Poliester

**Waga**  
402g/m<sup>2</sup>

**Szerokość rolki**  
144 cm

**Odporność na ścieranie**  
100 000 cykli Martindale  
(EN ISO 12947-2)

**Pilling**  
4 (EN ISO 12945-2)

**Odporność na światło**  
5 (EN ISO 105-B02:2014)

**Odporność koloru na tarcie**  
Mokre: 4-5 (UNI EN ISO 105-X12)  
Suche: 4-5 (UNI EN ISO 105-X12)

**Certyfikaty trudnopalności**  
-BS 5852: Part 1:1979  
Ignition Source 0 (Papieros)

**DE**

**Zusammensetzung**  
100% Polyester

**Gewicht**  
402g/m<sup>2</sup>

**Rollenbreite**  
144 cm

**Scheuerfestigkeit**  
100 000 Zyklen Martindale  
(EN ISO 12947-2)

**Pilling**  
4 (EN ISO 12945-2)

**Lichtechtheit**  
5 (EN ISO 105-B02:2014)

**Reibechtheit**  
Nass: 4-5 (UNI EN ISO 105-X12)  
Trocken: 4-5 (UNI EN ISO 105-X12)

**Feuersicherung**  
-BS 5852: Part 1:1979  
Ignition Source 0 (Zigarette)

**EN**

**Composition**  
100% Polyester

**Weight**  
402g/m<sup>2</sup>

**Roll width**  
144 cm

**Abrasion Resistance**  
100 000 Martindale cycles  
(EN ISO 12947-2)

**Pilling**  
4 (EN ISO 12945-2)

**Light Fastness**  
5 (EN ISO 105-B02:2014)

**Fastness to Rubbing**  
Wet: 4-5 (UNI EN ISO 105-X12)  
Dry: 4-5 (UNI EN ISO 105-X12)

**Flammability**  
-BS 5852: Part 1:1979  
Ignition Source 0 (Cigarette)



apretura wodoodporna  
wasserdichtes Finish  
water repellent



KA 085



KA 006



KA 210



KA 143

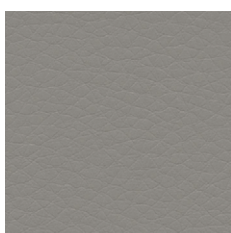

KA 710



KA 740

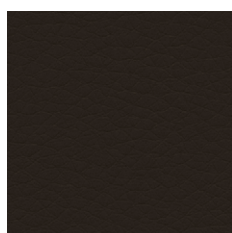

KA 250



KA 040



KA 009



KA 050



KA 032



KA 429



KA 035

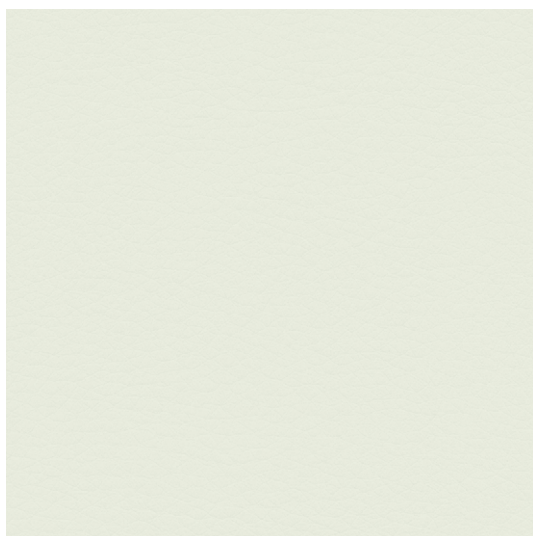

KA 003



KA 120



KA 755



KA 045



KA 780

**PL**

**Powłoka**  
100% PU

**Nośnik**  
65% Poliester, 35% Bawełna

**Waga**  
420 g/m<sup>2</sup> ± 10%

**Szerokość rolki**  
142 cm ± 2 cm

**Odporność na ścieranie**  
100,000 ± 5% cykli Martindale  
(UNI EN ISO 5470-2 method 1)

**Odporność na światło**  
>5 (ISO 105-B02)

**Odporność koloru na tarcie**  
Mokre: 5 (UNI EN ISO 105-X12)  
Suche: 5 (UNI EN ISO 105-X12)

**Certyfikaty trudnopalności**  
-BS 5852/DIN EN 1021-1:2014

**DE**

**Oberfläche**  
100% PU

**Gewebe**  
65% Polyester, 35% Baumwolle

**Gewicht**  
420 g/m<sup>2</sup> ± 10%

**Rollenbreite**  
142 cm ± 2 cm

**Scheuerfestigkeit**  
100,000 ± 5% Zyklen Martindale  
(UNI EN ISO 5470-2 method 1)

**Lichtechtheit**  
>5 (ISO 105-B02)

**Reibechtheit**  
Nass: 5 (UNI EN ISO 105-X12)  
Trocken: 5 (UNI EN ISO 105-X12)

**Feuersicherung**  
-BS 5852/DIN EN 1021-1:2014

**EN**

**Surface**  
100% PU

**Basic material**  
65% Polyester, 35% Cotton

**Weight**  
420 g/m<sup>2</sup> ± 10%

**Roll width**  
142 cm ± 2 cm

**Abrasion Resistance**  
100,000 ± 5% Martindale cycles  
(UNI EN ISO 5470-2 method 1)

**Light Fastness**  
>5 (ISO 105-B02)

**Fastness to Rubbing**  
Wet: 5 (UNI EN ISO 105-X12)  
Dry: 5 (UNI EN ISO 105-X12)

**Flammability**  
-BS 5852/DIN EN 1021-1:2014





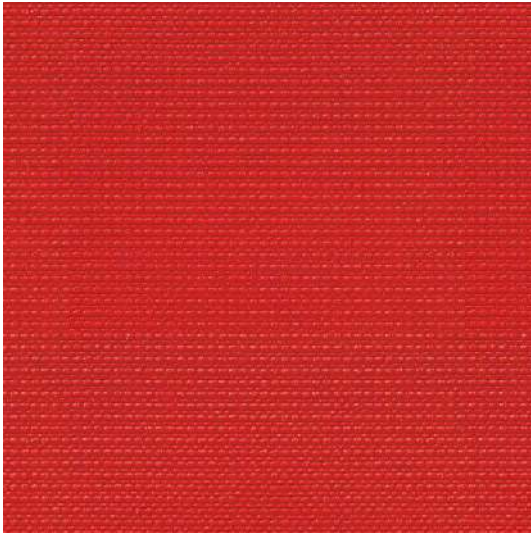

NC 075

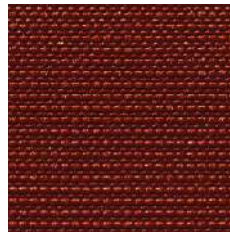

NC 072



NC 069



NC 049

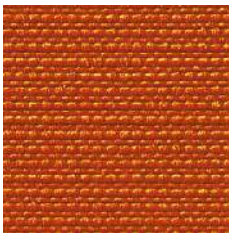

NC 074



NC 029



NC 067



NC 078

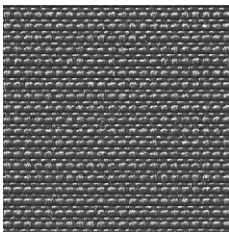

NC 046



NC 050



NC 012



NC 077

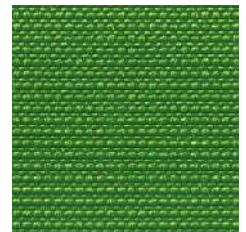

NC 076



NC 550



NC 549

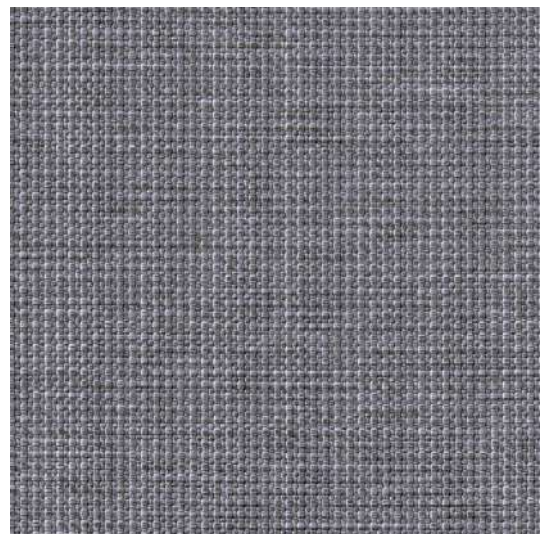

NC 546

**PL****Skład**

100% Poliester

**Waga**366 g/m<sup>2</sup> ± 15 g**Szerokość rolki**

140 cm

**Odporność na ścieranie**140 000 ± 5% cykli Martindale  
(PN-EN 14465: 2005/ A1:2007)**Pilling**

4-5 (UNI EN ISO 12945-2:2002)

**Odporność na światło**

3-4 (PN - EN ISO 105-B02: 2013)

**Odporność koloru na tarcie**Mokre: 4-5 (PN-EN ISO 105 X12:2005)  
Suche: 4-5 (PN-EN ISO 105 X12:2005)**Certyfikaty trudnopalności**-PN-EN 1021-1: 2007  
-PN-EN 1021-2: 2007**DE****Zusammensetzung**

100% Polyester

**Gewicht**366 g/m<sup>2</sup> ± 15 g**Rollenbreite**

140 cm

**Scheuerfestigkeit**140 000 ± 5% Zyklen Martindale  
(PN-EN 14465: 2005/ A1:2007)**Pilling**

4-5 (UNI EN ISO 12945-2:2002)

**Lichtechtheit**

3-4 (PN - EN ISO 105-B02: 2013)

**Reibechtheit**Nass: 4-5 (PN-EN ISO 105 X12:2005)  
Trocken: 4-5 (PN-EN ISO 105 X12:2005)**Feuersicherung**-PN-EN 1021-1: 2007  
-PN-EN 1021-2: 2007**EN****Composition**

100% polyester

**Weight**366 g/m<sup>2</sup> ± 15 g**Roll width**

140 cm

**Abrasion Resistance**140 000 ± 5% Martindale cycles  
(PN-EN 14465: 2005/ A1:2007)**Pilling**

4-5 (UNI EN ISO 12945-2:2002)

**Light Fastness**

3-4 (PN - EN ISO 105-B02: 2013)

**Fastness to Rubbing**Wet: 4-5 (PN-EN ISO 105 X12:2005)  
Dry: 4-5 (PN-EN ISO 105 X12:2005)**Flammability**-PN-EN 1021-1: 2007  
-PN-EN 1021-2: 2007



SN 084

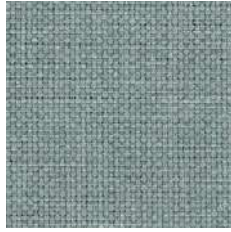

SN 072

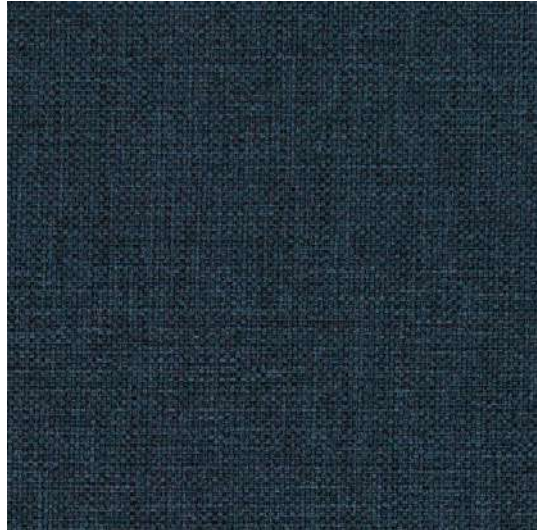

SN 080



SN 061



SN 017



SN 069



SN 011



SN 031



SN 034



SN 021



SN 005



SN 014

**PL**

**Skład**  
100% Poliester

**Waga**  
245g/m<sup>2</sup> ± 5%

**Szerokość rolki**  
140 cm

**Odporność na ścieranie**  
70,000 cykli Martindale  
(BS EN ISO 12947-2:1999)

**Pilling**  
4-5 (DIN EN ISO 12945/2:2000)

**Odporność na światło**  
4 (EN ISO 105-B02:2013)

**Odporność koloru na tarcie**  
Mokro: 4 (UNI EN ISO 105-X12:2016)  
Sucho: 4-5 (UNI EN ISO 105-X12:2016)

**Certyfikaty trudnopalności**  
-DIN EN 1021-1

**DE**

**Zusammensetzung**  
100% polyester

**Gewicht**  
245g/m<sup>2</sup> ± 5%

**Rollenbreite**  
140 cm

**Scheuerfestigkeit**  
70,000 Zyklen Martindale  
(BS EN ISO 12947-2:1999)

**Pilling**  
4-5 (DIN EN ISO 12945/2:2000)

**Lichtechtheit**  
4 (EN ISO 105-B02:2013)

**Reibechtheit**  
Nass: 4 (UNI EN ISO 105-X12:2016)  
Trocken: 4-5 (UNI EN ISO 105-X12:2016)

**Feuersicherung**  
-DIN EN 1021-1

**EN**

**Composition**  
100% Polyester

**Weight**  
245g/m<sup>2</sup> ± 5%

**Roll width**  
140 cm

**Abrasion Resistance**  
70,000 Martindale cycles  
(BS EN ISO 12947-2:1999)

**Pilling**  
4-5 (DIN EN ISO 12945/2:2000)

**Light Fastness**  
4 (EN ISO 105-B02:2013)

**Fastness to Rubbing**  
Wet: 4 (UNI EN ISO 105-X12:2016)  
Dry: 4-5 (UNI EN ISO 105-X12:2016)

**Flammability**  
-DIN EN 1021-1







2 grupa cenowa  
2. Preisgruppe  
2<sup>nd</sup> price group



CH 030



CH 022



CH 024



CH 041



CH 044



CH 045



CH 006



CH 009



CH 004



CH 005



CH 038



CH 040

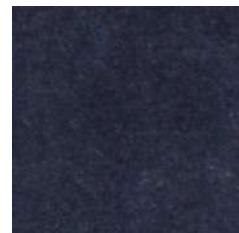

CH 002

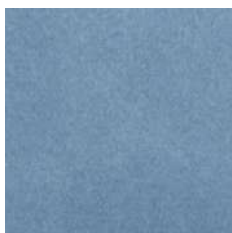

CH 034



CH 033



CH 001

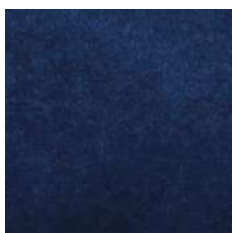

CH 032

**PL**

**Skład:**  
100% Poliester

**Waga:**  
433 g/m<sup>2</sup>

**Szerokość rolki:**  
140cm

**Odporność na ścieranie:**  
90 000 cykli Martindale'a  
(BS EN ISO 12947-2:2000)

**Pilling:**  
5 (EN ISO 12 945-2:2000)

**Odporność na światło:**  
5 (ISO 105-B02)

**Odporność koloru na tarcie:**  
Mokre: 4-5 (UNI EN ISO 105-X12)  
Suche: 4-5 (UNI EN ISO 105-X12)

**Certyfikaty trudnopalności:**  
-DIN EN 1021-1

**DE**

**Zusammensetzung:**  
100% Polyester

**Gewicht:**  
433 g/m<sup>2</sup>

**Rollenbreite:**  
140cm

**Scheuerfestigkeit:**  
90 000 Zyklen Martindale  
(BS EN ISO 12947-2:2000)

**Pilling:**  
5 (EN ISO 12 945-2:2000)

**Lichtechtheit**  
5 (ISO 105-B02)

**Reibechtheit**  
Nass: 4-5 (UNI EN ISO 105-X12)  
Trocken: 4-5 (UNI EN ISO 105-X12)

**Feuersicherung:**  
-DIN EN 1021-1

**EN**

**Composition:**  
100% Polyester

**Weight:**  
433 g/m<sup>2</sup>

**Roll width:**  
140cm

**Abrasion Resistance**  
90 000 Martindale cycles  
(BS EN ISO 12947-2:2000)

**Pilling:**  
5 (EN ISO 12 945-2:2000)

**Light Fastness**  
5 (ISO 105-B02)

**Fastness to Rubbing**  
Wet: 4-5 (UNI EN ISO 105-X12)  
Dry: 4-5 (UNI EN ISO 105-X12)

**Flammability:**  
-DIN EN 1021-1

- Tkanina Charles ze względu na strukturę (długi włos), podczas użytkowania może układać się w charakterystyczny dla tkanin welurowy sposób, tworząc wrażenie różnych odcieni tapicerki.
- Der Stoff Charles kann aufgrund seiner Struktur (langes Haar) im Gebrauch veloursartig angeordnet werden, wodurch der Eindruck von verschiedenen Polstertönen entsteht.
- Charles fabric, due to its structure (long hair), can be arranged in a velour way while being used, creating the impression of different shades of upholstery.



apretura wodoodporna  
wasserdichtes Finish  
water repellent

Przedstawiona kolorystyka nie stanowi oferty w rozumieniu prawa.  
Vorgestellte Farbgebung ist kein Angebot im Sinne der Rechtsvorschriften.  
The colors presented do not constitute an offer within the meaning of law.

**CHARLES**



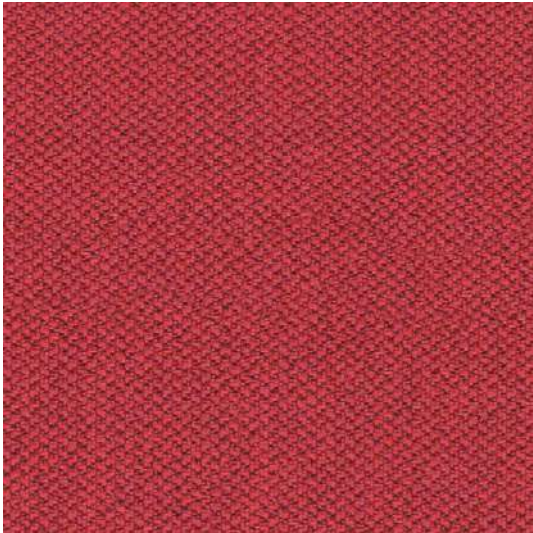

CSE 06

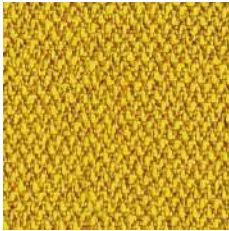

CSE 32

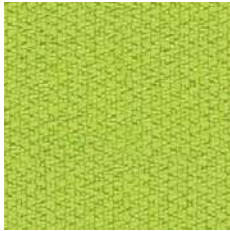

CSE 07



CSE 24

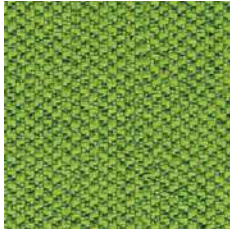

CSE 16

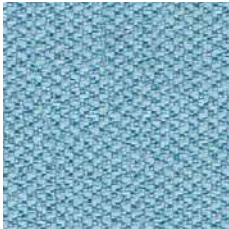

CSE 20

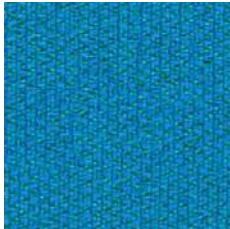

CSE 10



CSE 35

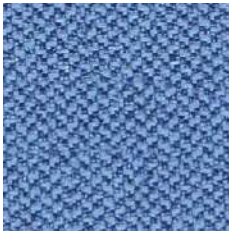

CSE 08



CSE 12



CSE 40



CSE 11



CSE 13



CSE 41



CSE 44

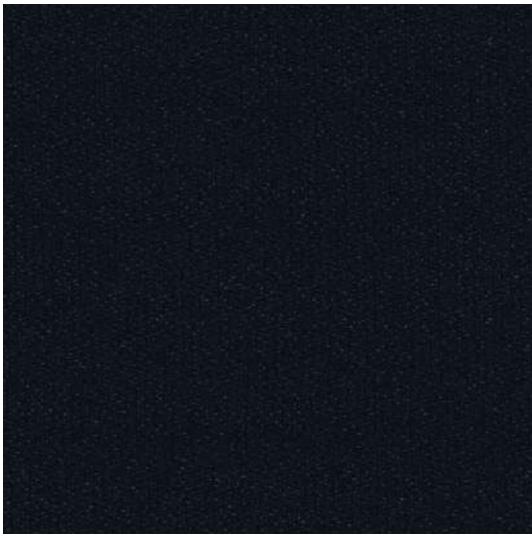

CSE 14

**PL****Skład**

100% Poliester  
nie zawiera barwników metalicznych

**Waga**

320g/m<sup>2</sup> ± 5%  
(448g/mb ±5%)

**Szerokość rolki**

140 cm

**Odporność na ścieranie**

≥ 100 000 cykli Martindale'a  
(BS EN ISO 12947-2:2016)

**Odporność na światło**

6 (ISO 105-B02):2013

**Odporność koloru na tarcie**

Mokre: 5 (AAT CC-8-2013)  
Suche: 4 (AAT CC-8-2013)

**Certyfikaty trudnopalności**

-BS EN 1021-1:2014  
-BS EN 1021-2:2014  
-BS 7176 Low Hazard

**DE****Zusammensetzung**

100% Polyester  
Nicht schwermetallhaltige Farbstoffe

**Gewicht**

320g/m<sup>2</sup> ± 5%  
(448g/lfd ±5%)

**Rollenbreite**

140 cm

**Scheuerfestigkeit**

≥ 100 000 Zyklen Martindale  
(BS EN ISO 12947-2:2016)

**Lichtechtheit**

6 (ISO 105-B02):2013

**Reibechtheit**

Nass: 5 (AAT CC-8-2013)  
Trocken: 4 (AAT CC-8-2013)

**Feuersicherung**

-BS EN 1021-1:2014  
-BS EN 1021-2:2014  
-BS 7176 Low Hazard

**EN****Composition**

100% Polyester  
Non metallic dyestuffs

**Weight**

320g/m<sup>2</sup> ± 5%  
(448g/lin.m ±5%)

**Roll width**

140 cm

**Abrasion Resistance**

≥ 100 000 Martindale cycles  
(BS EN ISO 12947-2:2016)

**Light Fastness**

6 (ISO 105-B02):2013

**Fastness to Rubbing**

Wet: 5 (AAT CC-8-2013)  
Dry: 4 (AAT CC-8-2013)

**Flammability**

-BS EN 1021-1:2014  
-BS EN 1021-2:2014  
-BS 7176 Low Hazard



G 0095



G 0069



G 0081



G 0082



G 0044



G 0070



G 0682



G 0083



G 0102



G 0683

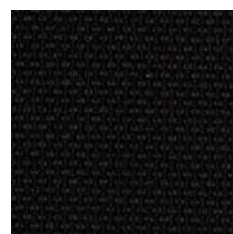

G 0099



G 0003



**PL**

**Skład**  
100% Poliester

**Waga**  
365g/m<sup>2</sup>

**Szerokość rolki**  
140 cm

**Odporność na ścieranie**  
150 000 cykli Martindale  
(EN ISO 12947-2-1998)/AC 2008  
według BS EN 14465:2003

**Pilling**  
4-5 (UNI EN ISO 12945/2):2000

**Odporność na światło**  
6-7 (ISO 105-B02: 2014) Method 2

**Odporność koloru na tarcie:**  
Mokre: 4-5 (UNI EN ISO 105-X12)  
Suche: 5 (UNI EN ISO 105-X12)

**Certyfikaty trudnopalności**  
-BS EN 1021-1 2014  
-BS EN 1021-2 2014  
-BS 5852 Part1: 1979  
-UNI 9175:2010 Class 11M

**DE**

**Zusammensetzung**  
100% Polyester

**Gewicht**  
365g/m<sup>2</sup>

**Rollenbreite**  
140 cm

**Scheuerfestigkeit**  
150 000 Zyklen Martindale  
(EN ISO 12947-2-1998)/AC 2008  
gemäß BS EN 14465:2003

**Pilling**  
4-5 (UNI EN ISO 12945/2):2000

**Lichtechtheit**  
6-7 (ISO 105-B02: 2014) Method 2

**Reibechtheit**  
Nass: 4-5 (UNI EN ISO 105-X12)  
Trocken: 5 (UNI EN ISO 105-X12)

**Feuersicherung**  
-BS EN 1021-1 2014  
-BS EN 1021-2 2014  
-BS 5852 Part1: 1979  
-UNI 9175:2010 Class 11M

**EN**

**Composition**  
100% Polyester

**Weight**  
365g/m<sup>2</sup>

**Roll width**  
140 cm

**Abrasion Resistance**  
150 000 Martindale cycles  
(EN ISO 12947-2-1998)/AC 2008  
according to BS EN 14465:2003

**Pilling**  
4-5 (UNI EN ISO 12945/2):2000

**Light Fastness**  
6-7 (ISO 105-B02: 2014) Method 2

**Fastness to Rubbing**  
Wet: 4-5 (UNI EN ISO 105-X12)  
Dry: 5 (UNI EN ISO 105-X12)

**Flammability**  
-BS EN 1021-1 2014  
-BS EN 1021-2 2014  
-BS 5852 Part1: 1979  
-UNI 9175:2010 Class 11M





PA 527

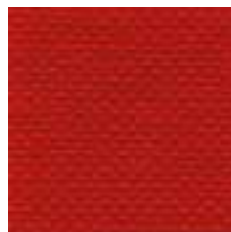

PA 010

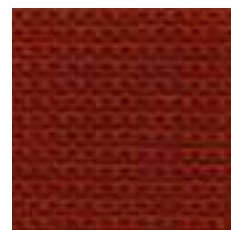

PA 511

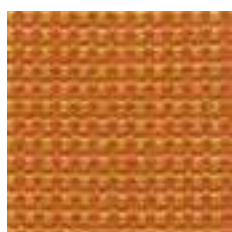

PA 930



PA 020

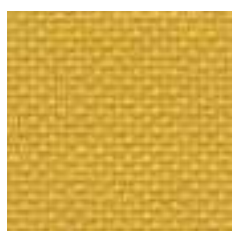

PA 390



PA 352



PA 531



PA 533



PA 153



PA 030

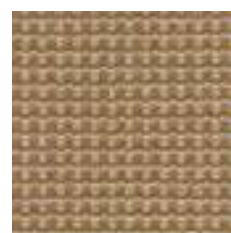

PA 532

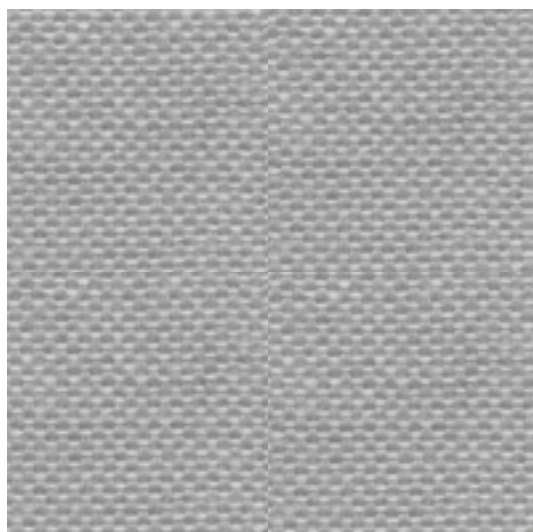

PA 854



PA 060



PA 560

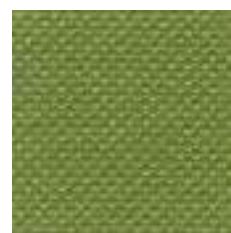

PA 065



PA 814

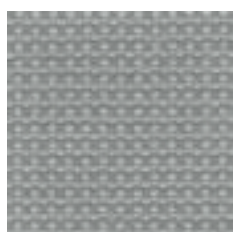

PA 555



PA 565

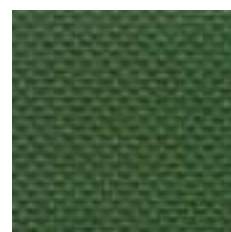

PA 736

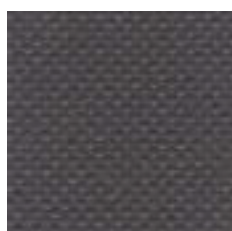

PA 810

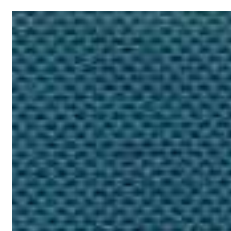

PA 653

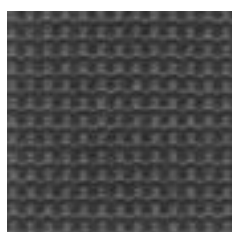

PA 571



PA 570



PA 050



PA 550

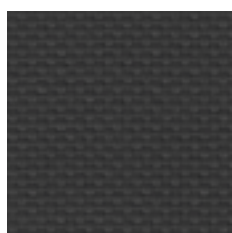

PA 833



PA 040



PA 541

**PL****Skład**

100% Poliester Trevira CS®

**Waga**

260g/m<sup>2</sup> ± 5%

**Szerokość rolki**

140 cm

**Odporność na ścieranie**

70 000 cykli Martindale  
(EN ISO 12947-2:2000)

**Pilling**

5 (ISO 12945-2:2002)

**Odporność koloru na tarcie:**

Mokro: 5 (ISO 105-X12:2016)  
Sucho: 5 (ISO 105-X12:2016)

**Odporność na światło**

6-7 (EN ISO 105-B02:2014)

**Certyfikaty trudnopalności**

- BS EN 1021-1:2006
- BS EN 1021-2:2006
- BS 5852 : 2006 (Crib 5)
- BS 7176 Medium Hazard
- NF P92 503-507 (M1)
- DIN 4102-1 (B1)
- IMO A 652 (16) part 8

**DE****Zusammensetzung**

100% Polyester Trevira CS®

**Gewicht**

260g/m<sup>2</sup> ± 5%

**Rollenbreite**

140 cm

**Scheuerfestigkeit**

70 000 Zyklen Martindale  
(EN ISO 12947-2:2000)

**Pilling**

5 (ISO 12945-2:2002)

**Reibechtheit**

Nass: 5 (ISO 105-X12:2016)  
Trocken: 5 (ISO 105-X12:2016)

**Lichtechtheit**

6-7 (EN ISO 105-B02:2014)

**Feuersicherung**

- BS EN 1021-1:2006
- BS EN 1021-2:2006
- BS 5852 : 2006 (Crib 5)
- BS 7176 Medium Hazard
- NF P92 503-507 (M1)
- DIN 4102-1 (B1)
- IMO A 652 (16) part 8

**EN****Composition**

100% Polyester Trevira CS®

**Weight**

260g/m<sup>2</sup> ± 5%

**Roll width**

140 cm

**Abrasion Resistance**

70 000 Martindale cycles  
(EN ISO 12947-2:2000)

**Pilling**

5 (ISO 12945-2:2002)

**Fastness to Rubbing**

Wet: 5 (ISO 105-X12:2016)  
Dry: 5 (ISO 105-X12:2016)

**Light Fastness**

6-7 (EN ISO 105-B02:2014)

**Flammability**

- BS EN 1021-1:2006
- BS EN 1021-2:2006
- BS 5852 : 2006 (Crib 5)
- BS 7176 Medium Hazard
- NF P92 503-507 (M1)
- DIN 4102-1 (B1)
- IMO A 652 (16) part 8

**PASTEL**





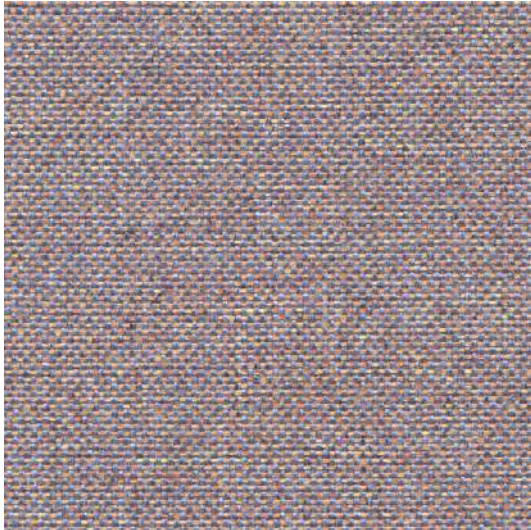

RC 658



RC 552



RC 656



RC 655



RC 455



RC 454



RC 353



RC 754



RC 752



RC 753



RC 152



RC 153

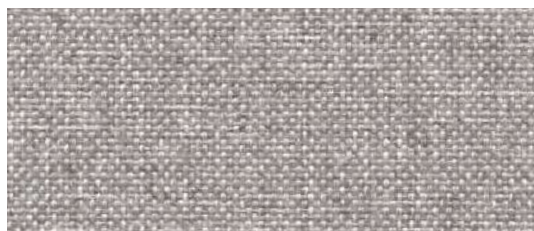

RC 851



RC 854



RC 255



RC 852

**PL**
**Skład**

100% Poliester Trevira CS®

**Waga**

250g/m<sup>2</sup> ± 5%

**Szerokość rolki**

140 cm

**Odporność na ścieranie**

70.000 cykli Martindale  
(UNI EN ISO 12947-2:2017)

**Pilling**

5 (UNI EN ISO 12945-2:2002)

**Odporność na światło**

7 (EN ISO 105-B02:2014)

**Odporność koloru na tarcie**

Mokre: 4-5 (UNI EN ISO 105-X12:2016)  
Suche: 4-5 (UNI EN ISO 105-X12:2016)

**Certyfikaty trudnopalności**

- EN 1021-1: 2006
- EN 1021-2: 2006
- BS 7176:2007 (Medium Hazard)
- BS 5852:2006 (CRIB 5)
- NFP 92-501-7 (M1)
- DIN 4102-1 (B1)
- IMO Res. A 652 (16) Part 8
- AM 18 (NF D 60013)
- UNI 9175 Class 1 IM

**DE**
**Zusammensetzung**

100% Poliester Trevira CS®

**Gewicht**

250g/m<sup>2</sup> ± 5%

**Rollenbreite**

140 cm

**Scheuerfestigkeit**

70.000 Zyklen Martindale  
(UNI EN ISO 12947-2:2017)

**Pilling**

5 (UNI EN ISO 12945-2:2002)

**Lichtechtheit**

7 (EN ISO 105-B02:2014)

**Reibechtheit**

Nass: 4-5 (UNI EN ISO 105-X12:2016)  
Trocken: 4-5 (UNI EN ISO 105-X12:2016)

**Feuersicherung**

- EN 1021-1: 2006
- EN 1021-2: 2006
- BS 7176:2007 (Medium Hazard)
- BS 5852:2006 (CRIB 5)
- NFP 92-501-7 (M1)
- DIN 4102-1 (B1)
- IMO Res. A 652 (16) Part 8
- AM 18 (NF D 60013)
- UNI 9175 Class 1 IM

**EN**
**Composition**

100% Poliester Trevira CS®

**Weight**

250g/m<sup>2</sup> ± 5%

**Roll width**

140 cm

**Abrasion Resistance**

70.000 Martindale cycles  
(UNI EN ISO 12947-2:2017)

**Pilling**

5 (UNI EN ISO 12945-2:2002)

**Light Fastness**

7 (EN ISO 105-B02:2014)

**Fastness to Rubbing**

Wet: 4-5 (UNI EN ISO 105-X12:2016)  
Dry: 4-5 (UNI EN ISO 105-X12:2016)

**Flammability**

- EN 1021-1: 2006
- EN 1021-2: 2006
- BS 7176:2007 (Medium Hazard)
- BS 5852:2006 (CRIB 5)
- NFP 92-501-7 (M1)
- DIN 4102-1 (B1)
- IMO Res. A 652 (16) Part 8
- AM 18 (NF D 60013)
- UNI 9175 Class 1 IM





KARO - **SN K**

SN K 084



HONEY - **SN H**

SN H 084



DOT - **SN D**

SN D 084

Dostępne kolory  
Verfügbare Farben  
Available colours



SN 084



SN 072



SN 011



SN 061

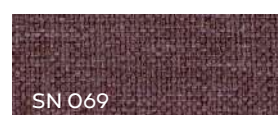

SN 069



SN 017

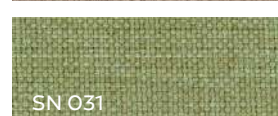

SN 031

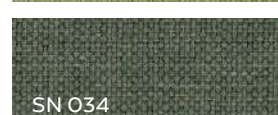

SN 034



SN 080

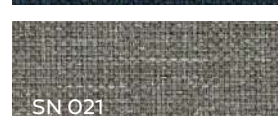

SN 021



SN 005

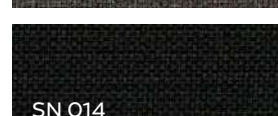

SN 014

**PL****Powłoka**

100% (PES) - Poliester

**Nośnik**

100% (PP) - Polipropylen

**Waga**

375g/m<sup>2</sup> ± 5%

**Szerokość rolki**

140 cm

**Odporność na ścieranie**

70 000 cykli Martindale  
(BS EN ISO 12947-2:1999)

**Pilling**

4-5 (DIN EN ISO 12945/2:2000)

**Odporność na światło**

4 (EN ISO 105-B02:2013)

**Odporność koloru na tarcie**

Mokre: 4 (UNI EN ISO 105-X12:2016)  
Suche: 4-5 (UNI EN ISO 105-X12:2016)

**Certyfikaty trudnopalności**

-DIN EN 1021-1

**DE****Oberfläche**

Oberfläche: 100% (PES) - Polyester

**Träger**

100% (PP) - Polypropylen

**Gewicht**

375g/m<sup>2</sup> ± 5%

**Rollenbreite**

140 cm

**Scheuerfestigkeit**

70 000 Zyklen Martindale  
(BS EN ISO 12947-2:1999)

**Pilling**

4-5 (DIN EN ISO 12945/2:2000)

**Lichtechtheit**

4 (EN ISO 105-B02:2013)

**Reibechtheit**

Nass: 4 (UNI EN ISO 105-X12:2016)  
Trocken: 4-5 (UNI EN ISO 105-X12:2016)

**Feuersicherung**

-DIN EN 1021-1

**EN****Surface**

100% PES - Polyester

**Backing**

100% PP - Polypropylen

**Weight**

375g/m<sup>2</sup> ± 5%

**Roll width**

140 cm

**Abrasion Resistance**

70 000 Martindale cycles  
(BS EN ISO 12947-2:1999)

**Pilling**

4-5 (DIN EN ISO 12945/2:2000)

**Light Fastness**

4 (EN ISO 105-B02:2013)

**Fastness to Rubbing**

Wet: 4 (UNI EN ISO 105-X12:2016)  
Dry: 4-5 (UNI EN ISO 105-X12:2016)

**Flammability**

-DIN EN 1021-1





VL 211



VL 619

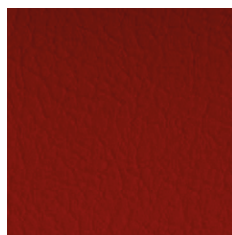

VL 275

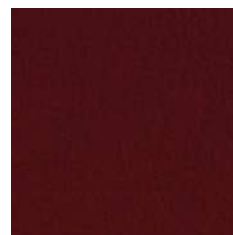

VL 262



VL 207

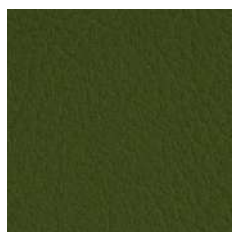

VL 501

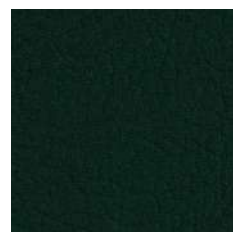

VL 569



VL 369

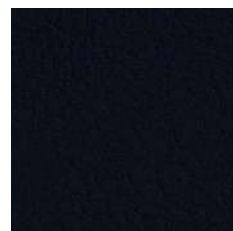

VL 368

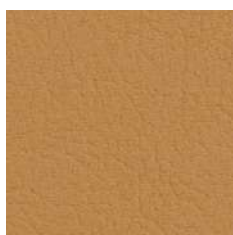

VL 217



VL 444



VL 020



VL 440



VL 445

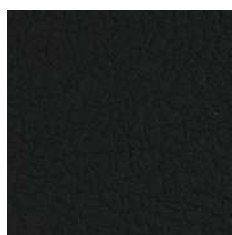

VL 403

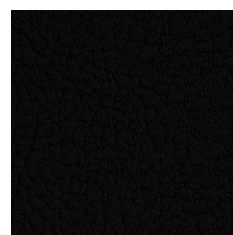

VL 935



**odporna na ścieranie**  
exzellente Abriebfestigkeit  
abrasion resistant



**odporna na promienie UV**  
lichtechtheit  
UV resistant

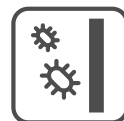

**ochrona przed mikroorganizmami**  
antimikrobiell ausgerüstet  
mildew resistant



**wodoodporna**  
wasserabweisend  
impermeability



**odporna na produkty chemiczne**  
chemikalienbeständig  
chemical resistant



**odporność na krew i mocz**  
resistenz gegen Blut und Urin  
resistance to blood and urine



**trudnozapałna**  
flammhemmend ausgerüstet  
flame retardant



**odporna na niskie temperatury**  
kältebruch resistent  
low temperature resistant

**PERMABLOK<sup>3</sup>**  
ADVANCED VINYL PROTECTION

**PL** Charakterystyka:

- bariera przed drobnoustrojami
- bariera przeciwbakteryjna
- bariera przeciwwgrzybiczna
- odporna na ścieranie
- odporna na zabrudzenia (krew, mocz)

**DE** Charakteristik:

- antimikrobielle Ausrüstung
- antibakterielle Ausrüstung
- antimykotische Ausrüstung
- hohe Abriebfestigkeit
- schmutzabweisend (Blut, Urin)

**EN** Characteristic:

- antimicrobial protection
- antibacterial protection
- antimyotic protection
- abrasion resistance
- resistance to dirt (Blood, Urine)

PERMABLOCK to sprawdzona powłoka chroniąca winyl, która tworzy mocną i skuteczną barierę przed największymi problemami występującymi w branży hotelarskiej i służbie zdrowia.

PERMABLOCK ist geprüfte Schutzschicht, die eine starke und effektive Barriere gegen die wichtigsten Probleme in der Hotelbranche und Krankenhauswesen ausmacht.

PERMABLOCK is proven vinyl protective coating, engineered to create a tough effective barrier against the biggest problems encountered in contract, healthcare and hospitality environments.

Należy unikać olejów, tłuszczów i substancji agresywnych (np. silne domowe środki czyszczące). Mogą one zniszczyć powierzchnię materiału. Zniszczenie materiału może doprowadzić do usunięcia plastyfikatorów i w rezultacie do stwardnienia materiału.

Man sollte Öle und starke Reinigungsmittel vermeiden. Sie können die Oberfläche des Stoffes beschädigen. Diese Beschädigung kann Entfernen von Weichmachern verursachen und zu Verhärtung des Stoffes führen.

Avoid contact with oils, fats or aggressive substances (e.g. strong household cleaners). These may damage the surface may lead to the extraction of plasticizers and consequently a rigidification of the material.

Barwniki i pigmenty mogą zabarwiać winyl. W szczególności materiały tekstylne mogą zawierać silne pigmenty (np. jeansy, kamizelki czy paski), których nie można całkowicie usunąć.

Farbstoffe und Pigmente können Vinyl verfärben, insbesondere Textilien, die starke Pigmente beinhalten (wie Jeanshosen, Westen, Gürtel), welche völlig nicht entfernt werden können.

Dyestuffs and colorant may discolor vinyl. Especially textiles can contain strong colorants (e.g. jeans, jackets or belts) which possibly cannot be removed completely.

**Powłoka**  
100% Winył

**Oberfläche**  
100% Vinyl

**Surface**  
100% Vinyl

**Nośnik**  
100% Poliester Hi-Loft 2™

**Gewebe**  
100% Polyester Hi-Loft 2™

**Basic material**  
100% Polyester Hi-Loft 2™

**Waga**  
650 g/m<sup>2</sup>

**Gewicht**  
650 g/m<sup>2</sup>

**Weight**  
650 g/m<sup>2</sup>

**Szerokość rolki**  
137 cm

**Rollenbreite**  
137 cm

**Roll width**  
137 cm

**Odporność na ścieranie**  
300 000 cykli Martindale'a  
(UNE-EN ISO 14465:2004)  
(UNE-EN ISO 12947-2 1999)

**Scheuerfestigkeit**  
300 000 Zyklen Martindale  
(UNE-EN ISO 14465:2004)  
(UNE-EN ISO 12947-2 1999)

**Fastness to Rubbing**  
300 000 Martindale cycles  
(UNE-EN ISO 14465:2004)  
(UNE-EN ISO 12947-2 1999)

**Odporność na światło**  
>7 (Xenon test DIN 54004)

**Lichtechtheit**  
>7 (Xenon test DIN 54004)

**Light Fastness**  
>7 (Xenon test DIN 54004)

**Trudnozapałność**  
-UNE EN 1021-1:2015  
-UNE EN 1021-2:2015  
-DIN 4102 B2  
-EN 71-2:2006 + A1:2007  
-IMO Res. MSC.307(88) - (2010 FTP Code) Annex 1 Part 8

**Feuersicherung**  
-UNE EN 1021-1:2015  
-UNE EN 1021-2:2015  
-DIN 4102 B2  
-EN 71-2:2006 + A1:2007  
-IMO Res. MSC.307(88) - (2010 FTP Code) Annex 1 Part 8

**Flammability**  
-UNE EN 1021-1:2015  
-UNE EN 1021-2:2015  
-DIN 4102 B2  
-EN 71-2:2006 + A1:2007  
-IMO Res. MSC.307(88) - (2010 FTP Code) Annex 1 Part 8

**Inne**  
-EN 71-3:2006 + A1:2007

**Andere**  
-EN 71-3:2006 + A1:2007

**Other**  
-EN 71-3:2006 + A1:2007

Przedstawiona kolorystyka nie stanowi oferty w rozumieniu prawa. Vorgestellte Farbgebung ist kein Angebot im Sinne der Rechtsvorschriften. The colours presented do not constitute an offer within the meaning of law.





A large, light gray, stylized number '3' is positioned on the left side of the page, extending from the top to the bottom. It has a thick, rounded stroke and a white cutout in the middle.

3 grupa cenowa  
3<sup>rd</sup> price group  
3. Preisgruppe



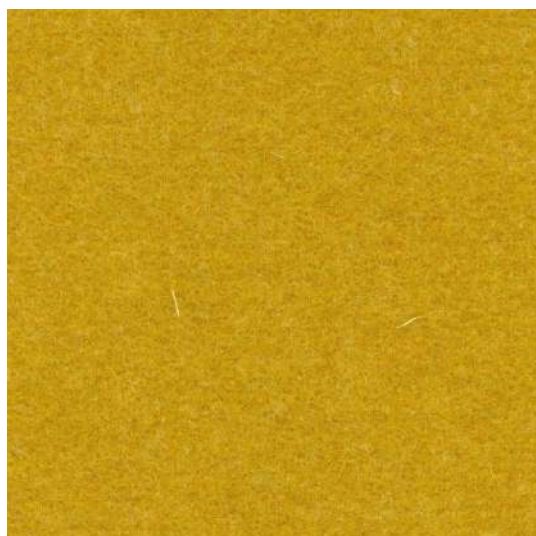

CUZ2W



CUZ39



CUZ18



CUZ21



CUZ90



CUZ63



CUZ1L

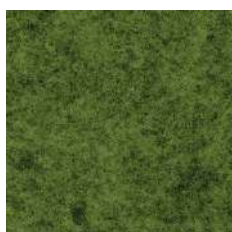

CUZ1K

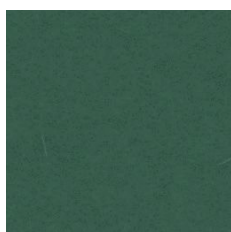

CUZ1N

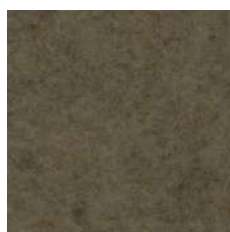

CUZ31

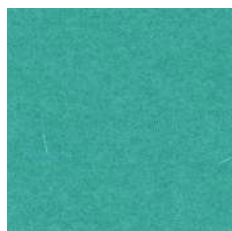

CUZ02



CUZ1R

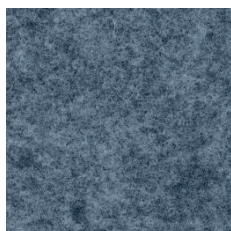

CUZ1W

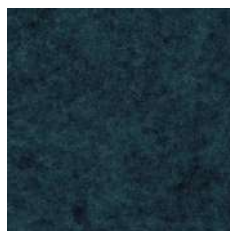

CUZ62



CUZ09



CUZ67



CUZ12



CUZ28



CUZ30



CUZ08

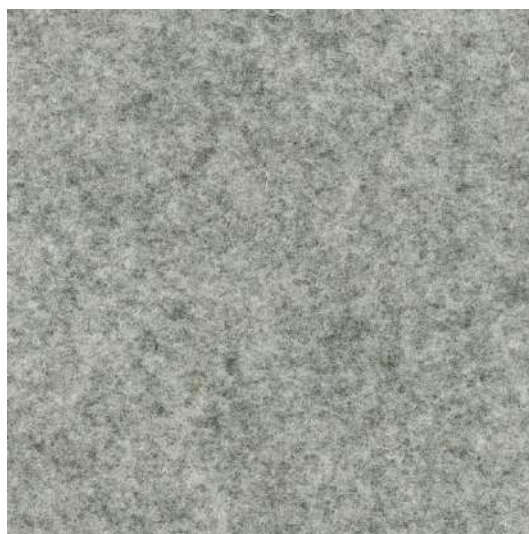

CUZ1E

**PL****Skład**

100% Wełna

**Waga**

460 g/m<sup>2</sup> ± 5%

**Szerokość rolki**

140 cm

**Odporność na ścieranie**

65 000 cykli Martindale'a  
(BS EN ISO 12947-2:2016)

**Pilling**

>3 (UNI EN ISO 12945/2):2000

**Odporność na światło**

5 (BS EN ISO 105:BO2:2014-BS6)

**Odporność koloru na tarcie**

Mokre: 5 (BS EN ISO 105-X12:2016)  
Suche: 4-5 (BS EN ISO 105-X12:2016)

**Certyfikaty trudnopalności**

-BS EN 1021 - 1:2014  
-BS EN 1021 - 2:2014  
-BS7176:2007 Low Hazard  
-UN 9175:2010 1IM  
-NFD60-013

**Czyszczenie**

-na sucho

**DE****Zusammensetzung**

100% Schurwolle

**Gewicht**

460 g/m<sup>2</sup> ± 5%

**Rollenbreite**

140 cm

**Scheuerfestigkeit**

65 000 Zyklen Martindale  
(BS EN ISO 12947-2:2016)

**Pilling**

>3 (UNI EN ISO 12945/2):2000

**Lichtechtheit**

5 (BS EN ISO 105:BO2:2014-BS6)

**Reibechtheit**

Nass: 5 (BS EN ISO 105-X12:2016)  
Trocken: 4-5 (BS EN ISO 105-X12:2016)

**Feuersicherung**

-BS EN 1021 - 1:2014  
-BS EN 1021 - 2:2014  
-BS7176:2007 Low Hazard  
-UN 9175:2010 1IM  
-NFD60-013

**Reinigung**

-Trockenreinigung

**EN****Composition**

100% Virgin Wool

**Weight**

460 g/m<sup>2</sup> ± 5%

**Roll width**

140 cm

**Abrasion Resistance**

65 000 Martindale cycles  
(BS EN ISO 12947-2:2016)

**Pilling**

>3 (UNI EN ISO 12945/2):2000

**Light Fastness**

5 (BS EN ISO 105:BO2:2014-BS6)

**Fastness to Rubbing**

Wet: 5 (BS EN ISO 105-X12:2016)  
Dry: 4-5 (BS EN ISO 105-X12:2016)

**Flammability**

-BS EN 1021 - 1:2014  
-BS EN 1021 - 2:2014  
-BS7176:2007 Low Hazard  
-UN 9175:2010 1IM  
-NFD60-013

**Cleaning**

-dry cleaning





CS 033



CS 430



CS 032



CS 421



CS 432



CS 201



CS 605



CS 602



CS 441



CS 601



CS 021



CS 125



CS 013

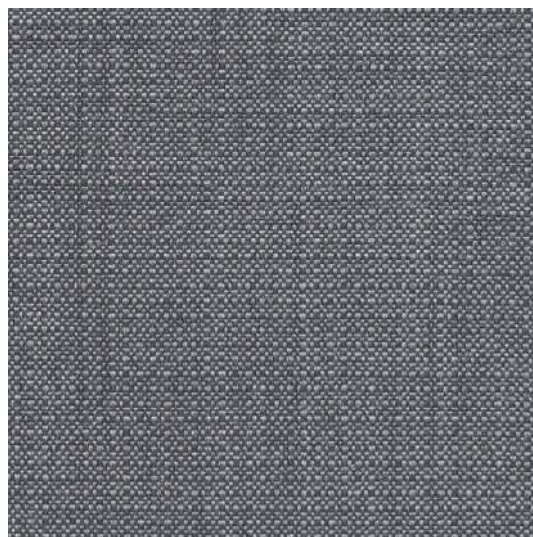

CS 022

**PL****Skład**

93% Wełna, 7% Poliamid

**Waga**

328 g/m<sup>2</sup>

**Szerokość rolki**

140 cm

**Odporność na ścieranie**

200.000 cykli Martindale  
(BS EN ISO 12947-2:1998 AC 2008)

**Pilling**

4-5 (BS EN ISO 12945-2:2000)

**Odporność na światło**

6-7 (ISO 105-B02)

**Odporność koloru na tarcie**

Mokre: 5 (UNI EN ISO 105-X12):2016  
Suche: 5 (UNI EN ISO 105-X12):2016

**Certyfikaty trudnopalności**

-BS EN 1021 1&2:2014  
-BS:5852 Part 1:1979  
-UNI 9175: 2010 Class 1 IM

**Inne**

-IMO Res. A.652 (16)  
-IMO Res.MSC 61 (67) Annex 1, Part 8  
-IMO Res.MSC 307 (88) Annex 1, Part 8

**DE****Zusammensetzung**

93% Schurwolle, 7% Poliamid

**Gewicht**

328 g/m<sup>2</sup>

**Rollenbreite**

140 cm

**Scheuerfestigkeit**

200.000 Zyklen Martindale  
(BS EN ISO 12947-2:1998 AC 2008)

**Pilling**

4-5 (BS EN ISO 12945-2:2000)

**Lichtechtheit**

6-7 (ISO 105-B02)

**Reibechtheit**

Nass: 4 (UNI EN ISO 105-X12):2016  
Trocken: 5 (UNI EN ISO 105-X12):2016

**Feuersicherung**

-BS EN 1021 1&2:2014  
-BS:5852 Part 1:1979  
-UNI 9175: 2010 Class 1 IM

**Andere**

-IMO Res. A.652 (16)  
-IMO Res.MSC 61 (67) Annex 1, Part 8  
-IMO Res.MSC 307 (88) Annex 1, Part 8

**EN****Composition**

93% Wool, 7% Polyamid

**Weight**

328 g/m<sup>2</sup>

**Roll width**

140 cm

**Abrasion Resistance**

200.000 Martindale cycles  
(BS EN ISO 12947-2:1998 AC 2008)

**Pilling**

4-5 (BS EN ISO 12945-2:2000)

**Light Fastness**

6-7 (ISO 105-B02)

**Fastness to Rubbing**

Wet: 4 (UNI EN ISO 105-X12):2016  
Dry: 5 (UNI EN ISO 105-X12):2016

**Flammability**

-BS EN 1021 1&2:2014  
-BS:5852 Part 1:1979  
-UNI 9175: 2010 Class 1 IM

**Other**

-IMO Res. A.652 (16)  
-IMO Res.MSC 61 (67) Annex 1, Part 8  
-IMO Res.MSC 307 (88) Annex 1, Part 8



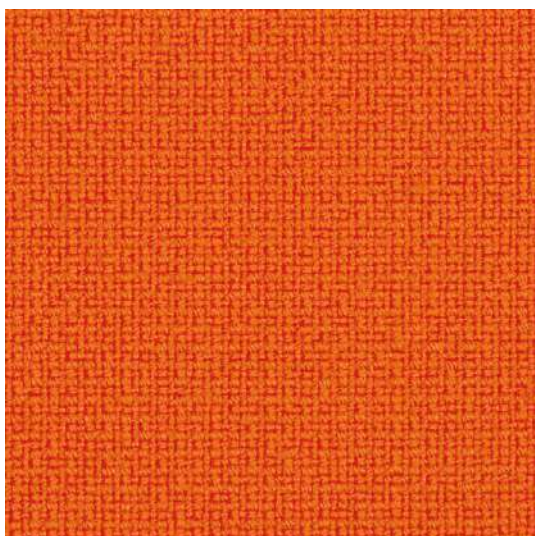

F 3016



F 4119



F 2067



F 8035

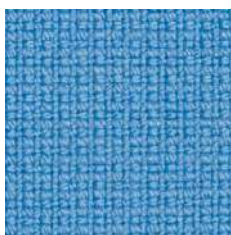

F 6118



F 6075

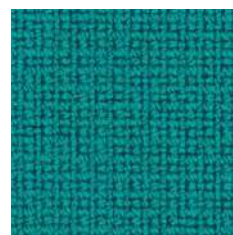

F 7016



F 6071



F 0017



F 0019



F 0099

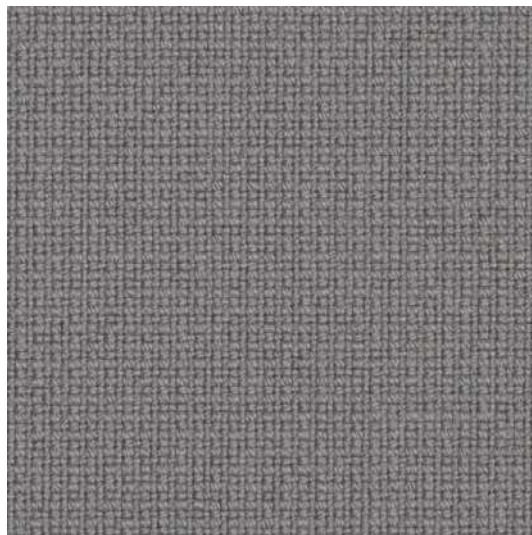

F 0078

**PL****Skład**

95% Wełna, 5% Poliamid

**Waga**

450 g/m<sup>2</sup>

**Szerokość rolki**

140 cm

**Odporność na ścieranie**

210 000 cykli Martindale  
(BS EN ISO 12947-2: 1998)

**Pilling**

3-4 (BS EN ISO 12945-2: 2000)

**Odporność na światło**

5-7 (BS EN ISO 105-B02: 2014)-BS7

**Odporność koloru na tarcie**

Mokre: 4-5 (UNI EN ISO 105-X12: 2002)  
Suche: 4-5 (UNI EN ISO 105-X12: 2002)

**Certyfikaty trudnopalności**

-BS EN 1021-1: 2014  
-BS EN 1021-2: 2014  
-BS 5852: 2006 Clause 11 Crib 5  
-UNI 9175: 2010 Class 1 IM  
-AM 18 NF D 60-013

**Inne**

-IMO Res. A.652 (16)  
-IMO Res.MSC 61 (67) Annex 1, Part 8  
-IMO Res.MSC 307 (88) Annex 1, Part 8

**Czyszczenie**

-na sucho

**DE****Zusammensetzung**

95% Schurwolle, 5% Poliamid

**Gewicht**

450 g/m<sup>2</sup>

**Rollenbreite**

140 cm

**Scheuerfestigkeit**

210 000 Zyklen Martindale  
(BS EN ISO 12947-2: 1998)

**Pilling**

3-4 (BS EN ISO 12945-2: 2000)

**Lichtechtheit**

5-7 (BS EN ISO 105-B02: 2014)-BS7

**Reibechtheit**

Nass: 4-5 (UNI EN ISO 105-X12: 2002)  
Trocken: 4-5 (UNI EN ISO 105-X12: 2002)

**Feuersicherung**

-BS EN 1021-1: 2014  
-BS EN 1021-2: 2014  
-BS 5852: 2006 Clause 11 Crib 5  
-UNI 9175: 2010 Class 1 IM  
-AM 18 NF D 60-013

**Andere**

-IMO Res. A.652 (16)  
-IMO Res.MSC 61 (67) Annex 1, Part 8  
-IMO Res.MSC 307 (88) Annex 1, Part 8

**Reinigung**

-Trockenreinigung

**EN****Composition**

95% Wool, 5% Polyamide

**Weight**

450 g/m<sup>2</sup>

**Roll width**

140 cm

**Abrasion Resistance**

210 000 Martindale cycles  
(BS EN ISO 12947-2: 1998)

**Pilling**

3-4 (BS EN ISO 12945-2: 2000)

**Light Fastness**

5-7 (BS EN ISO 105-B02: 2014)-BS7

**Fastness to Rubbing**

Wet: 4-5 (UNI EN ISO 105-X12: 2002)  
Dry: 4-5 (UNI EN ISO 105-X12: 2002)

**Flammability**

-BS EN 1021-1: 2014  
-BS EN 1021-2: 2014  
-BS 5852: 2006 Clause 11 Crib 5  
-UNI 9175: 2010 Class 1 IM  
-AM 18 NF D 60-013

**Other**

-IMO Res. A.652 (16)  
-IMO Res.MSC 61 (67) Annex 1, Part 8  
-IMO Res.MSC 307 (88) Annex 1, Part 8

**Cleaning**

-dry cleaning



easy to clean

SILVERTEX

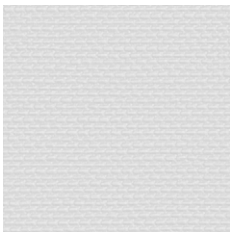

SV 280

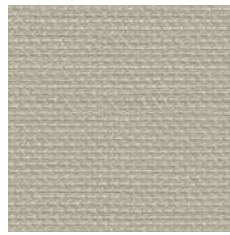

SV 001

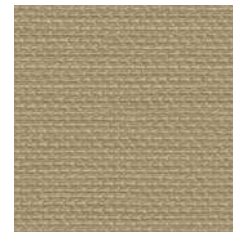

SV 009



SV 424

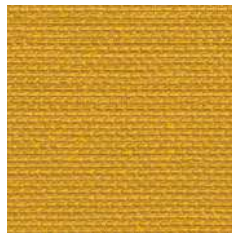

SV 065



SV 662

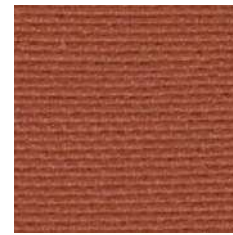

SV 661



SV 211



SV 010



SV 508



SV 064



SV 214



SV 563



SV 031



SV 067

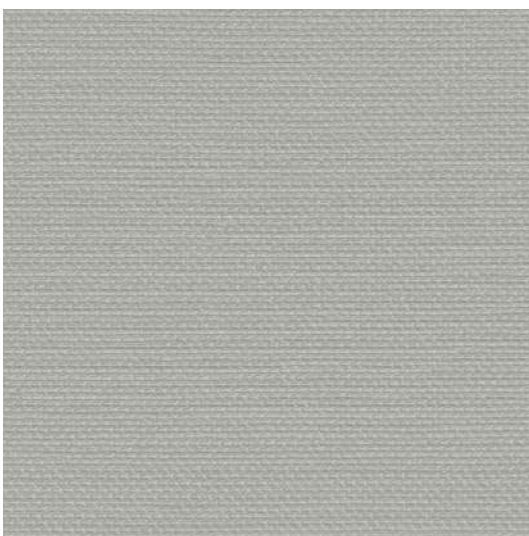

SV 401



SV 213



SV 307

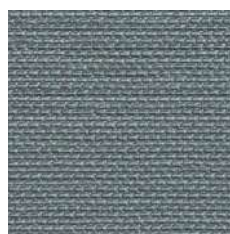

SV 402



SV 902



SV 901



**odporna na ścieranie**  
exzellente Abriebfestigkeit  
abrasion resistant

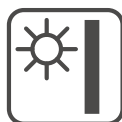

**odporna na promienie UV**  
lichtechtheit  
UV resistant

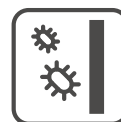

**ochrona przed mikroorganizmami**  
antimikrobiell ausgerüstet  
mildew resistant



**wodoodporna**  
wasserweisend  
impermeability



**odporna na produkty chemiczne**  
chemikalienbeständig  
chemical resistant



**odporność na krew i uryne**  
resistenz gegen Blut und Urin  
resistance to blood and urine



**trudnozapałna**  
flammhemmend ausgerüstet  
flame retardant



**odporna na niskie temperatury**  
kältenbruch resistent  
low temperature resistant



**PL** Charakterystyka:

- bariera przed drobnoustrojami
- bariera przeciwbakteryjna
- bariera przeciwgrzybiczna
- odporna na ścieranie
- odporna na zabrudzenia (krew, uryna)

**DE** Charakteristik:

- antimikrobielle Ausrüstung
- antibakterielle Ausrüstung
- antimykotische Ausrüstung
- hohe Abriebfestigkeit
- schmutzabweisend (Blut, Urin)

**EN** Characteristic:

- antimicrobial protection
- antibacterial protection
- antimycotic protection
- abrasion resistance
- resistance to dirt (Blood, Urine)

PERMABLOCK to sprawdzona powłoka chroniąca winyl, która tworzy mocną i skuteczną barierę przed największymi problemami występującymi w branży hotelarskiej i służbie zdrowia.

Należy unikać olejów, tłuszczów i substancji agresywnych (np. silne domowe środki czyszczące). Mogą one zniszczyć powierzchnię materiału. Zniszczenie materiału może doprowadzić do usunięcia plastyfikatorów i w rezultacie do stwardnienia materiału.

Barwniki i pigmenty mogą odbarwiać winyl. W szczególności materiały tekstylne mogą zawierać silne pigmenty (np. jeansy, kamizelki czy paski), których nie można całkowicie usunąć.

**Powłoka**  
100% Winył

**Nośnik**  
100% Poliester Hi-Loft 2™

**Waga**  
685 g/m<sup>2</sup>

**Szerokość rolki**  
137 cm

**Odporność na ścieranie**  
300 000 cykli Martindale  
(UNE EN 14465:2004+A1:2007)

**Odporność na światło**  
Xenontest (DIN 54004)-7

**Trudnozapałność**  
-EN 1021 Part 1 & 2: 2015  
-EN 71-2:2006+A1:2007  
-DIN 4102 B2  
-NF P 92-503/M2  
-UNI 9175 (1987) / UNI 9175/FA1 (1994) Classe 1.IM  
-(MED) Council Directive 96/98 EC on marine equipment  
-IMO A 652 (16) Annex I, 8,2 and 8,3

**Inne**  
-EN 71-3:2006+A1:2007

PERMABLOCK ist geprüfte Schutzschicht, die eine starke und effektive Barriere gegen die wichtigsten Probleme in der Hotelbranche und Krankenhauswesen ausmacht.

Man sollte Öle und starke Reinigungsmittel vermeiden. Sie können die Oberfläche des Stoffes beschädigen. Diese Beschädigung kann Entfernen von Weichmachern verursachen und zu Verhärtung des Stoffes führen.

Farbstoffe und Pigmente können Vinyl verfärben, insbesondere Textilien, die starke Pigmente beinhalten (wie Jeanshosen, Westen, Gürtel), welche völlig nicht entfernt werden können.

**Oberfläche**  
100% Vinyl

**Vinyl Träger**  
100% Polyester Hi-Loft 2™

**Gewicht**  
685 g/m<sup>2</sup>

**Rollenbreite**  
137 cm

**Scheuerfestigkeit**  
300 000 Zyklen Martindale  
(UNE EN 14465:2004+A1:2007)

**Xenontest (Lichtechtheit)**  
Xenontest (DIN 54004)-7

**Feuersicherung**  
-EN 1021 Part 1 & 2: 2015  
-EN 71-2:2006+A1:2007  
-DIN 4102 B2  
-NF P 92-503/M2  
-UNI 9175 (1987) / UNI 9175/FA1 (1994) Classe 1.IM  
-(MED) Council Directive 96/98 EC on marine equipment  
-IMO A 652 (16) Annex I, 8,2 and 8,3

**Andere**  
-EN 71-3:2006+A1:2007

PERMABLOCK is proven vinyl protective coating, engineered to create a tough effective barrier against the biggest problems encountered in contract, healthcare and hospitality environments.

Avoid contact with oils, fats or aggressive substances (e.g. strong household cleaners). These may damage the surface may lead to the extraction of plasticizers and consequently a rigidification of the material.

Dyestuffs and colorant may discolor vinyl. Especially textiles can contain strong colorants (e.g. jeans, jackets or belts) which possibly cannot be removed completely.

**Surface**  
100% Vinyl

**Vinyl Backing**  
100% Polyester Hi-Loft 2™

**Weight**  
685 g/m<sup>2</sup>

**Roll width**  
137 cm

**Fastness to Rubbing**  
300 000 Martindale cycles  
(UNE EN 14465:2004+A1:2007)

**Xenontest (Light Fastness)**  
Xenontest (DIN 54004)-7

**Flammability**  
-EN 1021 Part 1 & 2: 2015  
-EN 71-2:2006+A1:2007  
-DIN 4102 B2  
-NF P 92-503/M2  
-UNI 9175 (1987) / UNI 9175/FA1 (1994) Classe 1.IM  
-(MED) Council Directive 96/98 EC on marine equipment  
-IMO A 652 (16) Annex I, 8,2 and 8,3

**Other**  
-EN 71-3:2006+A1:2007

Przedstawiona kolorystyka nie stanowi oferty w rozumieniu prawa. Vorgestellte Farbgebung ist kein Angebot im Sinne der Rechtsvorschriften. The colours presented do not constitute an offer within the meaning of law.





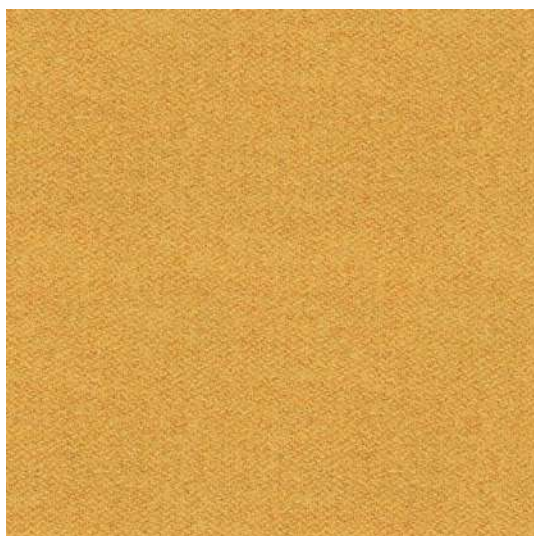

LDS 44

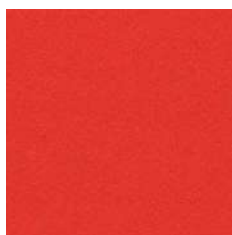

LDS 80



LDS 86

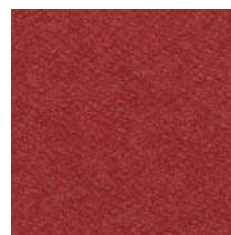

LDS 85

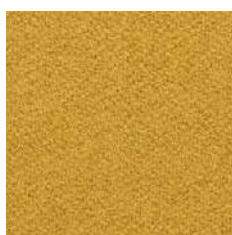

LDS 28



LDS 82

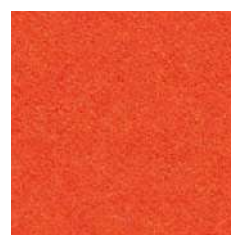

LDS 81



LDS 46



LDS 47



LDS 55



LDS 56



LDS 57



LDS 59



LDS 63



LDS 62



LDS 08



LDS 21



LDS 16



LDS 35



LDS 17

**PL****Skład**

95% Wełna, 5% Poliamid

**Waga**

400g/m<sup>2</sup> ± 5%

**Szerokość rolki**

140 cm

**Odporność na ścieranie**

100.000 cykli Martindale  
(BS EN ISO 12947-2: 2016)

**Pilling**

4 (BS EN ISO 12945-2: 2000)

**Odporność na światło**

5 (BS EN ISO 105-B02: 2014-BS6)

**Odporność koloru na tarcie**

Mokre: 4 (UNI EN ISO 105-X12)

Suche: 4 (UNI EN ISO 105-X12)

**Certyfikaty trudnopalności**

-BS EN 1021-1: 2014  
-BS EN 1021-2: 2014  
-BS 7176 Low Hazard  
-UNI 9175: 2010 Class 1 IM  
-ÖNORM B 3825 & A 3800-1

**DE****Zusammensetzung**

95% Schurwolle, 5% Polyamid

**Gewicht**

400g/m<sup>2</sup> ± 5%

**Rollenbreite**

140 cm

**Scheuerfestigkeit**

100.000 Zyklen Martindale  
(BS EN ISO 12947-2: 2016)

**Pilling**

4 (BS EN ISO 12945-2: 2000)

**Lichtechtheit**

5 (BS EN ISO 105-B02: 2014-BS6)

**Reibechtheit**

Nass: 4 (UNI EN ISO 105-X12)

Trocken: 4 (UNI EN ISO 105-X12)

**Feuersicherung**

-BS EN 1021-1: 2014  
-BS EN 1021-2:2 014  
-BS 7176 Low Hazard  
-UNI 9175: 2010 Class 1 IM  
-ÖNORM B 3825 & A 3800-1

**EN****Composition**

95% Virgin Wool, 5% Polyamide

**Weight**

400g/m<sup>2</sup> ± 5%

**Roll width**

140 cm

**Abrasion Resistance**

100.000 Martindale cycles  
(BS EN ISO 12947-2: 2016)

**Pilling**

4 (BS EN ISO 12945-2: 2000)

**Light Fastness**

5 (BS EN ISO 105-B02: 2014-BS6)

**Fastness to Rubbing**

Wet: 4 (UNI EN ISO 105-X12)

Dry: 4 (UNI EN ISO 105-X12)

**Flammability**

-BS EN 1021-1: 2014  
-BS EN 1021-2: 2014  
-BS 7176 Low Hazard  
-UNI 9175: 2010 Class 1 IM  
-ÖNORM B 3825 & A 3800-1







4 grupa cenowa  
4<sup>th</sup> price group  
4. Preisgruppe



RX 612



RX 643



RX 632



RX 933



RX 912



RX 733



RX 762



RX 123



RX 163



RX 173



RX 393

**PL****Skład**

90% Wełna, 10% Nylon

**Waga**

~300 g/m<sup>2</sup>

**Szerokość rolki**

138 cm

**Odporność na ścieranie**

100 000 cykli Martindale  
(EN ISO 12947-2:2016)

**Pilling**

4-5 (EN ISO 12945-2:2000)

**Odporność na światło**

5-7 (EN ISO 105-B02:2014)

**Odporność koloru na tarcie**

Mokre: 4-5 (EN ISO 105-X12:2001)  
Suche: 4-5 (EN ISO 105-X12:2001)

**Certyfikaty trudnopalności**

-BS EN 1021-1/2:2014  
-BS 5852:Part 1:1979  
-Önorm B1/Q1  
-NF D 60 013  
-UNI 9175 1IM  
-IMO FTP Code 2010: Part 8

**Czyszczenie**

Odkurzanie i czyszczenie chemiczne

**DE****Zusammensetzung**

90% Schurwolle, 10% Nylon

**Gewicht**

~300 g/m<sup>2</sup>

**Rollenbreite**

138 cm

**Scheuerfestigkeit**

100 000 Zyklen Martindale  
(EN ISO 12947-2:2016)

**Pilling**

4-5 (EN ISO 12945-2:2000)

**Lichtechtheit**

5-7 (EN ISO 105-B02:2014)

**Reibechtheit**

Nass: 4-5 (EN ISO 105-X12:2001)  
Trocken: 4-5 (EN ISO 105-X12:2001)

**Feuersicherung**

-BS EN 1021-1/2:2014  
-BS 5852:Part 1:1979  
-Önorm B1/Q1  
-NF D 60 013  
-UNI 9175 1IM  
-IMO FTP Code 2010: Part 8

**Reinigung**

Staubsaugen und Reinigung

**EN****Composition**

90% Virgin Wool, 10% Nylon

**Weight**

~300 g/m<sup>2</sup>

**Roll width**

138 cm

**Abrasion Resistance**

100 000 Martindale cycles  
(EN ISO 12947-2:2016)

**Pilling**

4-5 (EN ISO 12945-2:2000)

**Light Fastness**

5-7 (EN ISO 105-B02:2014)

**Fastness to Rubbing**

Wet: 4-5 (EN ISO 105-X12:2001)  
Dry: 4-5 (EN ISO 105-X12:2001)

**Flammability**

-BS EN 1021-1/2:2014  
-BS 5852:Part 1:1979  
-Önorm B1/Q1  
-NF D 60 013  
-UNI 9175 1IM  
-IMO FTP Code 2010: Part 8

**Cleaning**

Vacuuming and dry cleaning





S-336

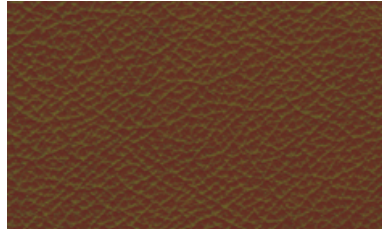

B-478



S-154



C-181

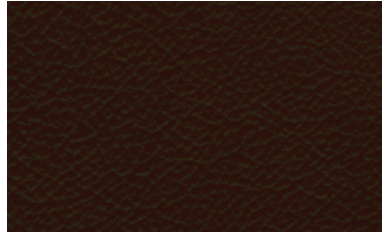

B-5458

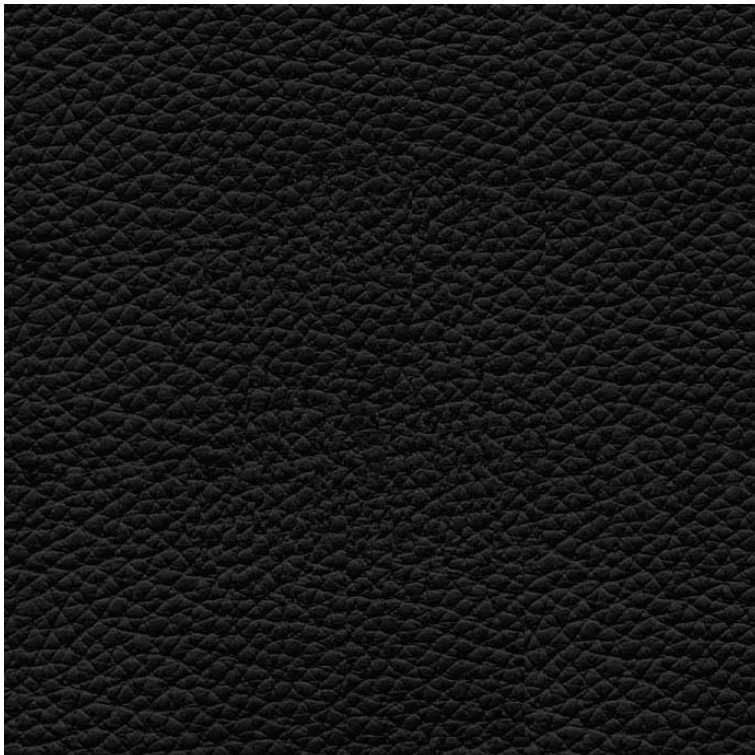

S-black



S-white



S-120



S-antracyt

**PL****Wielkość blamu**~4.2m<sup>2</sup>**Grubość**

&gt;0.9 mm - 1.1 mm

**Test tarcia na mokro**

&gt;250 (BS EN ISO 11640: 1998)

**Test tarcia na sucho**

&gt;500 (BS EN ISO 11640:1998)

**Zginanie**

50.000 cykli (BS EN ISO 5402:2002)

-Nie stosowano PCP i CFC podczas procesu garbowania

-Mogą występować niewielkie zmiany w odcieniu i strukturze

**Certyfikaty trudnopalności**

-EN 1021-1:2006

-EN 1021-2:2006

**DE****Groesse Ca.**~4.2m<sup>2</sup>**Dicke**

&gt;0.9 mm - 1.1 mm

**Rebungstest nass**

&gt;250 (BS EN ISO 11640: 1998)

**Rebungstest trocken**

&gt;500 (BS EN ISO 11640:1998)

**Flexometry**

50.000 Zyklen (BS EN ISO 5402:2002)

-PCP und CFC bei Gerben wurden nicht verwendet

-Es koennen kleine Unterschiede in der Faerbung hervortreten

**Feuersicherung**

-EN 1021-1:2006

-EN 1021-2:2006

**EN****Size Ca.**~4.2m<sup>2</sup>**Thickness**

&gt;0.9 mm - 1.1 mm

**Wet rub test**

&gt;250 (BS EN ISO 11640: 1998)

**Dry rub test**

&gt;500 (BS EN ISO 11640:1998)

**Flexometry**

50.000 cycles (BS EN ISO 5402:2002)

-No PCP or CFC used during tanning process

-Natural colour variations may occur

**Flammability**

-EN 1021-1:2006

-EN 1021-2:2006





ścieg ozdobny/ decorative stich  
haft / embroidery / Stickerei  
filc/felt/filz  
membrana / membrane / Membrany  
melamina / melamine / Melamin  
metal / metal / Metall  
drewno / wood / Holz  
plastik / Kunststoff / plastic

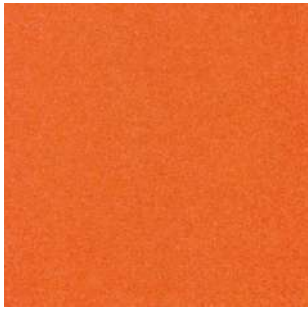

3004

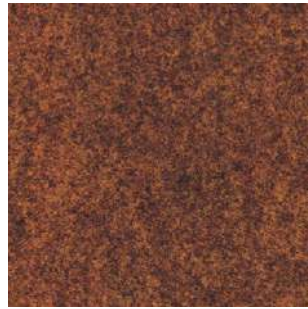

3006



4002



6011



6013



2021



7025



7040

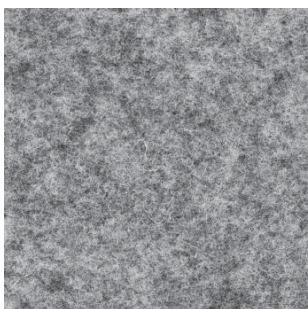

5318

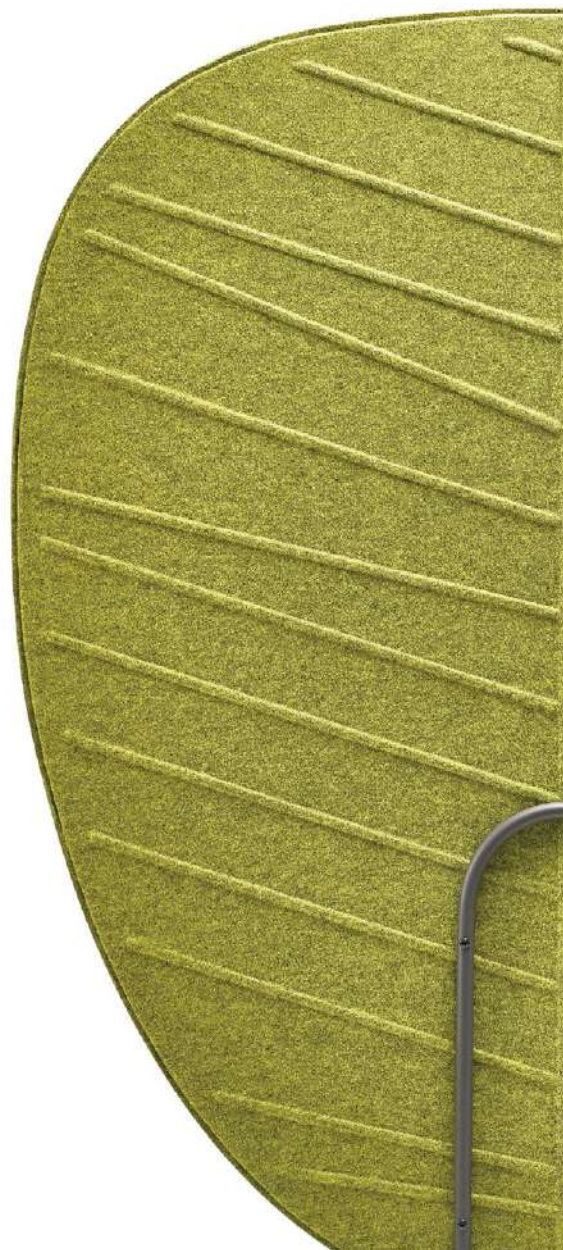

**PL****Skład**

C 5318 – 100% Poliester  
Pozostałe kolory – 100% Polipropylen

**Waga**

300g/m<sup>2</sup> ± 10%  
(ISO-9073-1)

**Grubość**

3,0 mm ± 10%  
(ISO-9073-2)

**Szerokość rolki**

C 5318 – 150 cm +- 3  
Pozostałe kolory – 155 cm +- 3

**Trudnopalność**

-PN-EN 1021-1:2014  
-PN-EN 1021-2:2014

**DE****Zusammensetzung**

C 5318 – 100% Polyester  
Andere Farben – 100% Polypropylen

**Gewicht**

300g/m<sup>2</sup> ± 10%  
(ISO-9073-1)

**Dicke**

3,0 mm ± 10%  
(ISO-9073-2)

**Rollenbreite**

C 5318 – 150 cm +- 3  
Andere Farben – 155 cm +- 3

**Feuersicherung**

-PN-EN 1021-1:2014  
-PN-EN 1021-2:2014

**EN****Composition**

C 5318 – 100% Polyester  
Other colours – 100% Polypropylene

**Weight**

300g/m<sup>2</sup> ± 10%  
(ISO-9073-1)

**Thickness**

3,0 mm ± 10%  
(ISO-9073-2)

**Roll width**

C 5318 – 150 cm +- 3  
Other colours – 155 cm +- 3

**Flammability**

-PN-EN 1021-1:2014  
-PN-EN 1021-2:2014

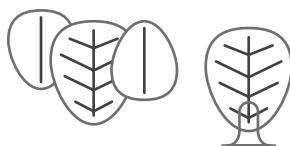

Karta przedstawia przykładowe wielkości haftów.  
Wielkość i wzór zależą od indywidualnych potrzeb klientów.

Diese Karte zeigt eine mögliche Stickerei-Größe. Die Größe und das Muster sind abhängig von den individuellen Bedürfnissen des Kunden.

The sheet contains examples of embroidery sizes. Logo size and project depend on individual customers' needs.



50 cm<sup>2</sup>

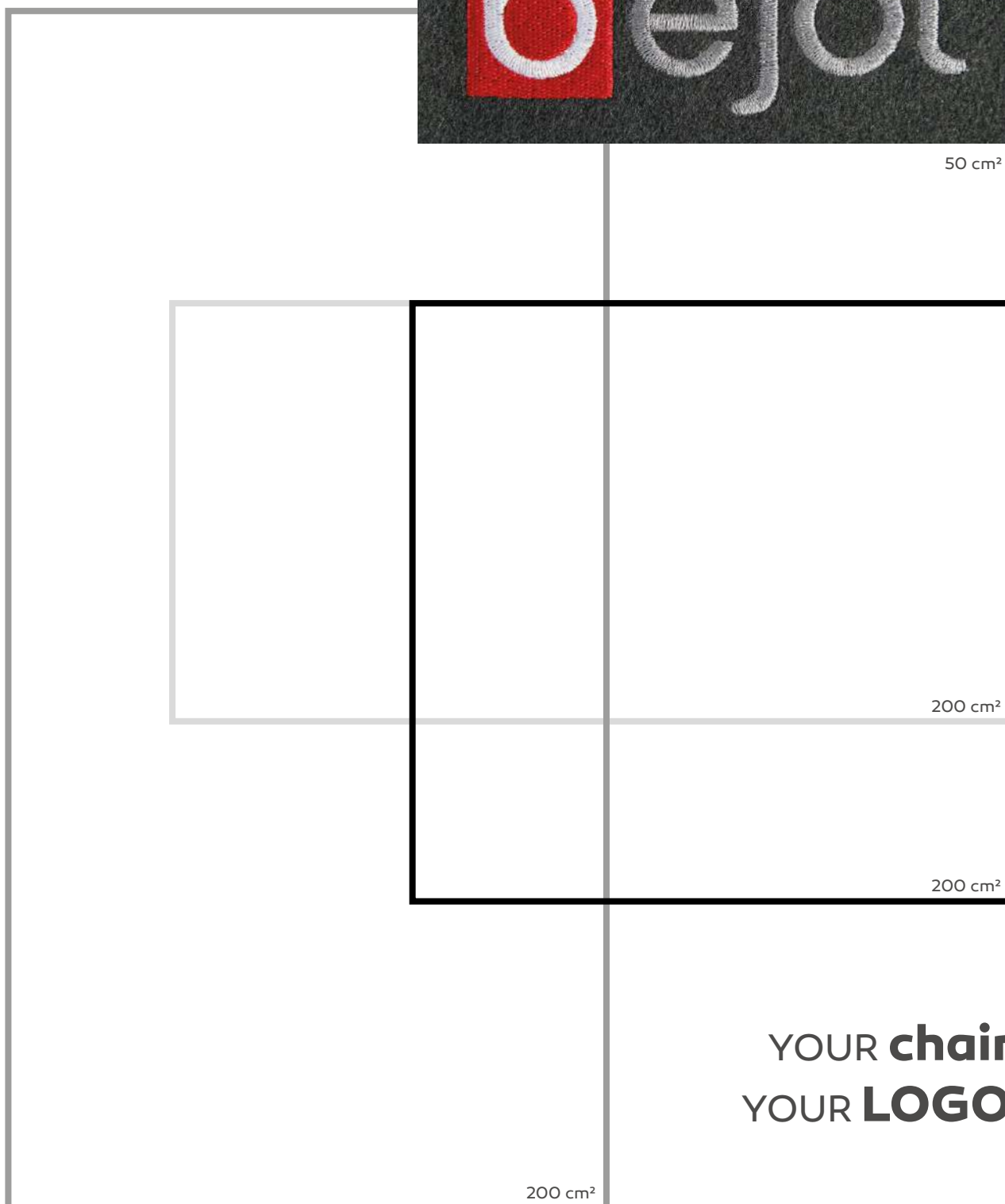

200 cm<sup>2</sup>

200 cm<sup>2</sup>

200 cm<sup>2</sup>

YOUR **chair**  
YOUR **LOGO**

## PL Wymagania, jakie należy spełnić przy zamówieniu z haftem:

- w zamówieniu należy wskazać produkty w których ma zostać wykonany haft
- przesłany wzór logo należy opisać numerem zamówienia, którego dotyczy
- wymagane formaty to: **.pdf / .eps / .ai / .jpg / .bmp**
- grafika musi dokładnie przedstawiać logo, którego haft ma zostać umieszczony na produktach (nie przerabiamy wzorów logo)
- wraz z przesłanym wzorem należy określić wysokość i szerokość haftu (maksymalnie 10cm x 20cm)
- należy przesłać zdjęcie lub rysunek z dokładnie zaznaczonym umiejscowieniem haftu na produkcie według poniższego wzoru

Ze względu na rozbieżność odczytu komputerowego ostateczne kolory logo mogą w niewielkim stopniu różnić się od przesłanego wzoru. Jeśli klient wymaga całkowitej zgodności z przesłanym wzorem, konieczne jest przesłanie oznaczeń zgodnych z wzornikiem Pantone. W takim wypadku próbka z haftem zostaje wysłana do akceptacji. Od momentu uzyskania akceptacji haftu zostaje rozpoczęta produkcja.

## DE Forderungen die beim Bestellen von Produkten mit einer Logo-Stickerei zu erfüllen sind:

- geben Sie in ihrer Bestellung die Namen der Produkte an, die mit Logo bestickt sein sollten
- geben Sie die Nummer der Bestellung an, auf die sich das Logomuster bezieht
- die zulässigen Formate der Dateien mit dem Logo sind: **.pdf / .eps / .ai / .jpg / .bmp**
- das Logomuster muss das Logo genau darstellen (wir überarbeiten Logomuster nicht)
- geben Sie die gewünschte Höhe und Breite der Stickerei an (maximale Abmessungen: 10cm x 20cm)
- Schicken Sie ein Foto oder eine Zeichnung mit genauer Lage der Stickerei auf dem Produkt nach folgendem Beispiel

Die endgültigen Farben des Logo können sich von dem zugeschickten Muster durch eine Computerverarbeitung geringfügig unterscheiden. Wünschen Sie sich eine völlige Übereinstimmung mit dem zugeschickten Muster wünschen, müssen Sie sich der Pantone Schablonen bedienen. In diesem Fall werden wir Ihnen ein Muster mit der Stickerei zuschicken und mit der Produktion erst nach Ihrer Freigabe beginnen.

## EN Requirements to be met when ordering embroidered products:

- give the names of the products in which embroidery is to be made in your order
- give the order number to which the sent logo file applies
- required formats of the file with the logo: **.pdf / .eps / .ai / .jpg / .bmp**
- the logo file must exactly present the logo the embroidery of which is to be placed on the products (we do not modify logo patterns)
- state the exact height and width of the embroidery with the sent pattern (maximum dimensions: 10cm x 20cm)
- send a photograph or a drawing showing the exact location of the embroidery on the product according to the template below

Because of the deviations in the computer readout, the final colors of the logo may slightly differ from the sent logo. If you require total conformity with the sent pattern, you must use Pantone color templates. In such case, a sample with embroidery will be sent to your approval, and we will start the production after its acceptance.

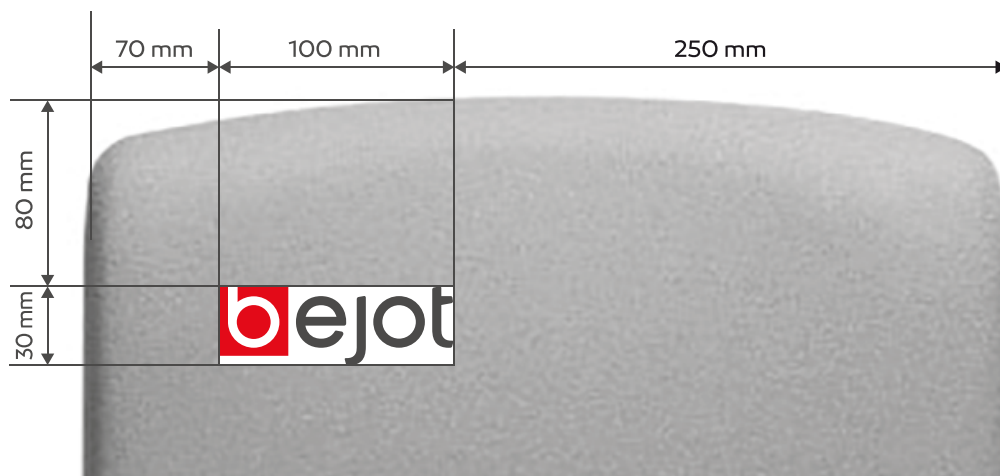

## SIATKA BATYLINE/ BATYLINE MESH

**Serge Ferrari**

Wzornik siatek do foteli Eleven i Kyos Mesh  
Batyline meshmuster für Eleven und Kyos Mesh  
Batyline mesh sampler for Eleven and Kyos Mesh

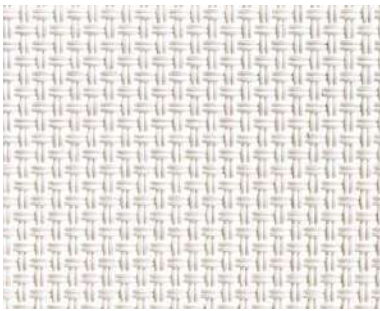

M 5001

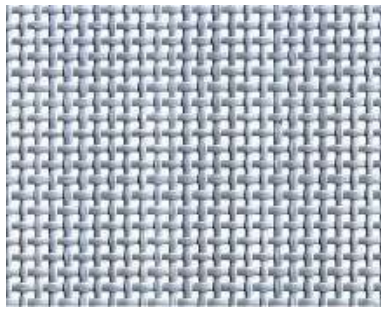

M 5003

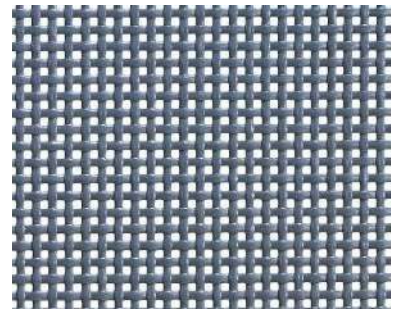

M 5004

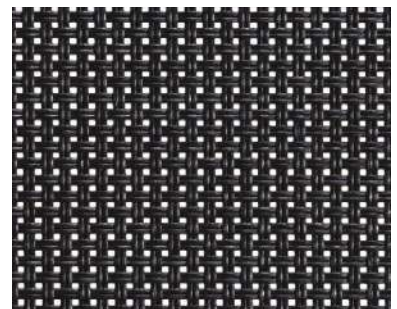

M 5005

## SIATKA O/ MESH O

Wzornik siatki MESH O dla foteli Ovidio  
MESH O muster für Ovidio  
MESH O sampler for Ovidio

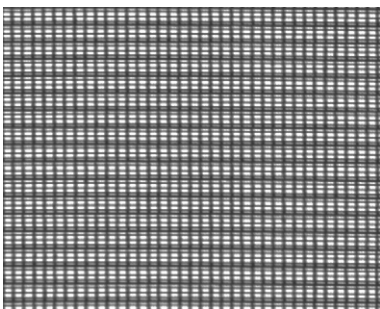

MOBL

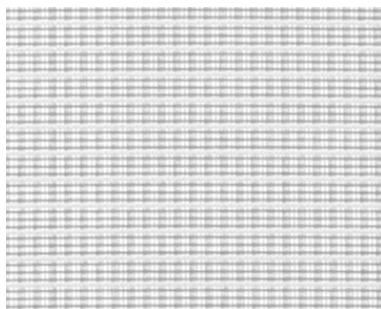

MOLG

**SIATKA BATYLINE/ BATYLINE MESH Serge Ferrari****PL****Skład**  
Poliester/PVC**Szerokość**  
180 cm**Waga**  
500 g/m<sup>2</sup>**Odporność na ścieranie**  
150 000 cykli Martindale  
(UNI EN ISO 12947-2:1999)**Odporność na światło**  
≥7 (EN ISO 105-B02 Xenontest)**KORZYŚCI**

- Odporność na ścieranie, maksymalna wytrzymałość.
- Utrzymanie regularnych napięć: brak zjawiska workowatości.
- Pozostaje chłodna latem, bardzo szybko schnie.

**DE****Zusammensetzung**  
Polyester/PVC**Breite**  
180 cm**Gewicht**  
500 g/m<sup>2</sup>**Scheuerfestigkeit**  
150 000 Zyklen Martindale  
(UNI EN ISO 12947-2:1999)**Lichtechtheit**  
≥7 (EN ISO 105-B02 Xenontest)**VORTEILE**

- Scheuerfest, maximale Festigkeit
- Haltung regulärer Spannungen: keine Sackförmigkeit
- Es bleibt im Sommer angenehm kühl, trocknet sehr schnell

**EN****Composition**  
Polyester/PVC**Width**  
180 cm**Weight**  
500 g/m<sup>2</sup>**Abrasion Resistance**  
150 000 Martindale cycles  
(UNI EN ISO 12947-2:1999)**Light Fastness**  
≥7 (EN ISO 105-B02 Xenontest)**BENEFITS**

- Tear resistant, maximum strenght
- Tension regularly maintained: no bagging phenomenon
- Stays cool in summer, dries very quickly

**SIATKA O/ MESH O****PL****Skład**  
Polyelastomer 56% + Poliester 44%**Waga**  
428 g/m<sup>2</sup>**Odporność na ścieranie**  
>50 000 cykli Martindale  
(BS EN ISO 12947-2:1999)**Pilling**  
4-5 (BS EN ISO 12945-2:2000)**Odporność na światło**  
>4 (EN ISO 105-B02:2014)**DE****Zusammensetzung**  
Polyelastomer 56% + Polyester 44%**Gewicht**  
428 g/m<sup>2</sup>**Scheuerfestigkeit**  
>50 000 Zyklen Martindale  
(BS EN ISO 12947-2:1999)**Pilling**  
4-5 (BS EN ISO 12945-2:2000)**Lichtechtheit**  
>4 (EN ISO 105-B02:2014)**EN****Composition**  
Polyelastomer 56% + Polyester 44%**Weight**  
428 g/m<sup>2</sup>**Abrasion Resistance**  
>50 000 Martindale cycles  
(BS EN ISO 12947-2:1999)**Pilling**  
4-5 (BS EN ISO 12945-2:2000)**Light Fastness**  
>4 (EN ISO 105-B02:2014)



## MEMBRANA/ MEMBRANE

---

Wzornik membran dla fotel String  
Membranemuster für String  
Membrane sampler for String



MB01



MB06

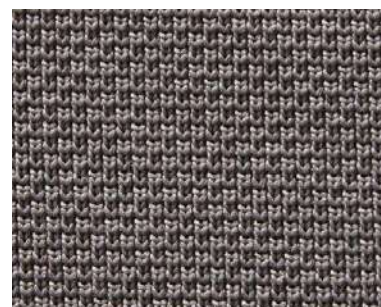

MB07

**Wersja String 103** - z wysokim oparciem - pozostaje dostępna tylko w kolorze czarnym MB 01

**String 103** - hohe Version - nur mit schwarze Membrane erreichbar MB 01

**Model String 103** - with high backrest - will remain in offer only with black colour membrane MB 01

## SIATKA MESH M/ MESH M

---

Wzornik siatki MESH M dla foteli Kyos Mesh, Fendo Mesh, Momo, Milla  
MESH M muster für Kyos Mesh, Fendo Mesh, Momo, Milla  
MESH M sampler for Kyos Mesh, Fendo Mesh, Momo, Milla



M08



M09

## MEMBRANA/ MEMBRANE

**PL**

**Skład**  
100% nylon

**Waga**  
570 g/m<sup>2</sup>

**Odporność na ścieranie**  
100 000 cykli Martindale  
(UNI EN ISO 12947/2):1999

**Certyfikaty trudnopalności**  
-BS EN 1021 - 1:2006  
-BS EN 1021 - 2:2006

**DE**

**Zusammensetzung**  
100% nylon

**Gewicht**  
570 g/m<sup>2</sup>

**Scheuerfestigkeit**  
100 000 Zyklen Martindale  
(UNI EN ISO 12947/2):1999

**Feuersicherung**  
-BS EN 1021 - 1:2006  
-BS EN 1021 - 2:2006

**EN**

**Composition**  
100% nylon

**Weight**  
570 g/m<sup>2</sup>

**Abrasion Resistance**  
100 000 Martindale cycles  
(UNI EN ISO 12947/2):1999

**Flammability**  
-BS EN 1021 - 1:2006  
-BS EN 1021 - 2:2006

## SIATKA M/ MESH M

**PL**

**Skład**  
66% poliester, 34% poliamid

**Waga**  
210 g/m<sup>2</sup>

**Odporność na ścieranie**  
90 000 ± 5% cykli Martindale  
-PN EN 14465:2005 + A1:2007  
-PN EN 12947:2017-02

**Odporność na światło**  
7 (EN ISO 105-B02:2014)

**Certyfikaty trudnopalności**  
-BS EN 1021:2006 - 1

**DE**

**Zusammensetzung**  
66% Polyester, 34% Polyamid

**Gewicht**  
210 g/m<sup>2</sup>

**Scheuerfestigkeit**  
90 000 ± 5% Zyklen Martindale  
-PN EN 14465:2005 + A1:2007  
-PN EN 12947:2017-02

**Lichtechtheit**  
7 (EN ISO 105-B02:2014)

**Feuersicherung**  
-BS EN 1021:2006 - 1

**EN**

**Composition**  
66% polyester, 34% polyamid

**Weight**  
210 g/m<sup>2</sup>

**Abrasion Resistance**  
90 000 ± 5% Martindale cycles  
-PN EN 14465:2005 + A1:2007  
-PN EN 12947:2017-02

**Light Fastness**  
7 (EN ISO 105-B02:2014)

**Flammability**  
-BS EN 1021:2006 - 1



# ŚCIEG OZDOBNY DECORATIVE STICHES DESIGN STEPPUNG



Kod nici:  
Code of thread:  
Nähte-Kode:

**T 1702**  
biały  
white  
weiß

**T 9573**  
szary  
grey  
grau

**T 8465**  
beżowy  
beige  
beige

**T 2517**  
pomarańczowy  
orange  
orange

**T 0381**  
czerwony  
red  
rot

**T 0839**  
zielony  
green  
grün

Sugerowane dla:  
Suggested for:  
Vorgeschlagen für:

**Tkanin:**  
**Fabrics:**  
**Stoffe:**  
SKÓRA/ LEATHER/LEDER  
KEIMO  
VALENCIA  
SILVERTEX

**Kolekcji:**  
**Collections:**  
**Kolektion:**  
CEO  
DUAL  
ELEVEN  
IN ACCESS  
LUMI  
ORTE 3DH  
OX:CO  
SPIN  
UMM  
VOO VOO



Przedstawiona kolorystyka nie stanowi oferty w rozumieniu prawa.  
The colours presented do not constitute an offer within the meaning of law.  
Vorgestellte Farbgebung ist kein Angebot im Sinne der Rechtsvorschriften.



RAL 3005  
M - mat/matte/mat



RAL 3020  
P - połysk/gloss/Glanz



RAL 2001  
M - mat/matte/mat

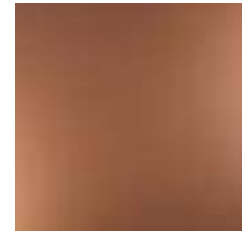

miedz/copper\*\*  
P - połysk/gloss/Glanz

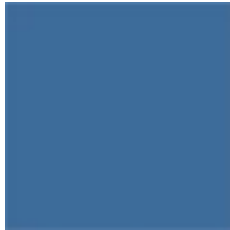

RAL 5007  
M - mat/matte/mat



RAL 5003  
M - mat/matte/mat



RAL 6005  
M - mat/matte/mat



gold  
P - połysk/gloss/Glanz

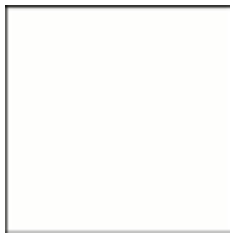

RAL 9010  
P - połysk/gloss/Glanz  
S\* - struktura/structure/  
Struktur

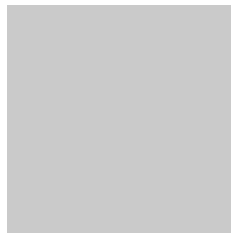

RAL 7047  
P - połysk/gloss/Glanz  
M - mat/matte/mat  
S\* - struktura/structure/  
Struktur



RAL 7045  
M - mat/matte/mat  
S\* - struktura/structure/  
Struktur

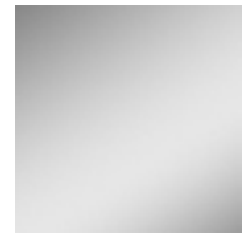

alu  
P - połysk/gloss/Glanz



RAL 9005  
M - mat/matte/mat  
S - struktura/structure/  
Struktur



RAL 7024  
P - połysk/gloss/Glanz  
S\* - struktura/structure/  
Struktur



chrom

**Stolik TB OUT**

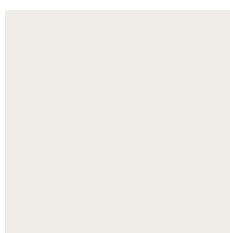

0500



5540



8010

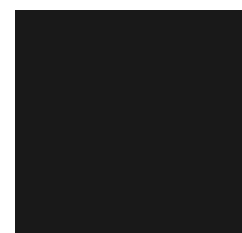

9000

## SKY\_LINE



SK119



SK155



SK320



SK361



SK509

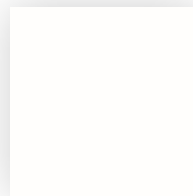

SK916



SK711

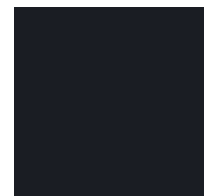

SK917

## MORK

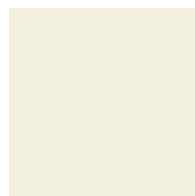

MK901

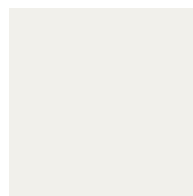

MK903



MK115

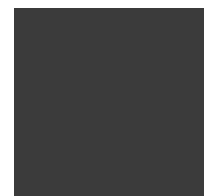

MK721



MK133

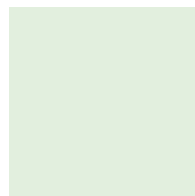

MK619

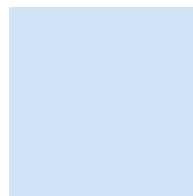

MK524

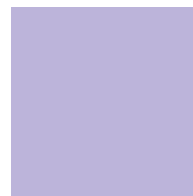

MK405

## EGGO

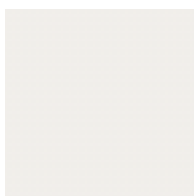

E0500



E6005

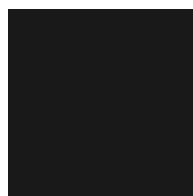

E9000



E6030



E1085



E2060

KYOS

---

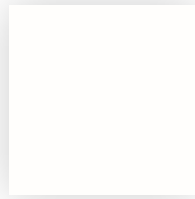

K903



K740



K905

FENDO

---



FD119



FD300

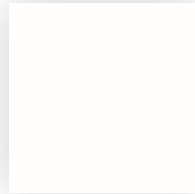

FD903



FD712



FD905

SPLIT

---



SP554



SP185

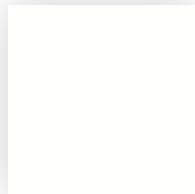

SPO50

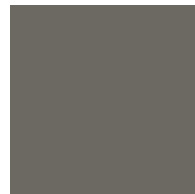

SP605

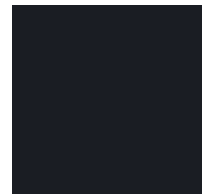

SP900



SP801

SHELL

---



S115



S208



S327



S617

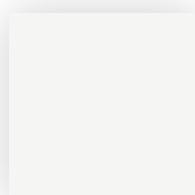

S903

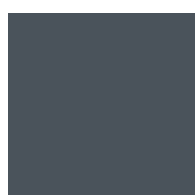

S712



S511



S905

PLASTIK/ KUNSTSTOFF/ PLASTIC

DREWNO LITE BUK - TRES  
 BUCHENVOLLHOLZ - TRES  
 SOLID BEECH WOOD - TRES



**B2**  
 bielony  
 gebleichte  
 bleached

**B3**  
 czarny  
 schwarz  
 black

**B5**  
 biały  
 weiß  
 white

**B6**  
 szary  
 grau  
 gray

DREWNO LITE JESION  
 ESCHENVOLLHOLZ  
 SOLID ASH WOOD

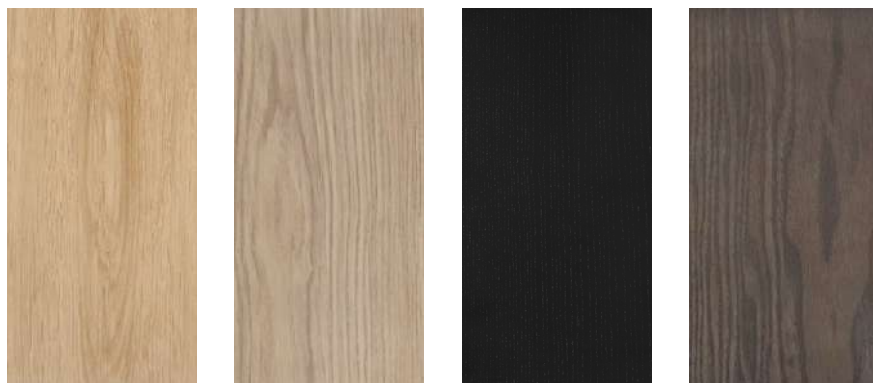

**J1**  
 naturalny  
 natürliche  
 natural

**J2**  
 bielony  
 gebleichte  
 bleached

**J3**  
 czarny  
 schwarz  
 black

**J4**  
 szarobrzązowy  
 grau-braun  
 gray-brown

DREWNO LITE DĄB  
 EICHENVOLLHOLZ  
 SOLID OAK WOOD

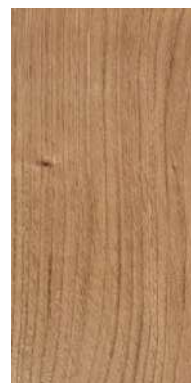

**O1**  
 naturalny  
 natürliche  
 natural

\* Drewno lite dąb tylko pod indywidualne zamówienie (z dłuższym terminem realizacji.) Dopłata zgodna z cennikiem.

\* Massives Eichenholz nur auf Bestellung, mit längerer Lieferzeit. Zuschlag gemäß der Preisliste

\* Solid oak wood only on demand, with a longer delivery time. Surcharge according to the price list.

PANEL/DREWNO LITE - TREEHOUSE/BEACHHOUSE  
 PANEEL/MASSIVHOLZ - TREEHOUSE/BEACHHOUSE  
 PANEL/SOLID WOOD - TREEHOUSE/BEACHHOUSE



**P1**  
 sosna/ kiefer/ pine  
 naturalna  
 natürliche  
 natural

**P2**  
 sosna/ kiefer/ pine  
 bielona  
 gebleichte  
 bleached

**P3**  
 sosna/ kiefer/ pine  
 czarna  
 schwarz  
 black

**P4**  
 sosna/ kiefer/ pine  
 szarobrzązowa  
 grau-braun  
 gray-brown

**O1**  
 dąb/ eiche/ oak  
 naturalny  
 natürliche  
 natural

KOLEKCJA KOLLEKTION COLLECTION	MODEL MODELL MODEL	DREWNO LITE JESION	DREWNO LITE DĄB	DREWNO LITE BUK	PANELE PANEL PANELS	
		ESCHENVOLLHOLZ SOLID ASH WOOD	EICHEVOLLHOLZ SOLID OAK WOOD	BUCHENVOLLHOLZ SOLID BEECHWOOD	sosna/ kiefer/ pine	dąb/ kiefer/ oak
		stelaż (nogi jesionowe)/ Massiv Golz Esche Solid ash wood legs	stelaż (nogi dębowe)/ Massiv Golz Eiche Solid oak wood legs	stelaż (nogi bukawe)/ Massiv Golz Buche Solid beech wood legs		
BEACHHOUSE	BH W				•	•
LEAF_POD	LP SFP, LP SFM	•				
LUMI	LM W	•				
OX:CO	OX W	•	•			
ORTE	OT W	•	•			
QUADRA	QD SBG				•	•
MORK	MR W	•				
SKY_LINE	SK W	•	•			
SPIN	SN W	•	•			
TABLES	TB W	•	•			
TB CONFERENCE	TB CONF		•			
TREEHOUSE	TH, THW THS, THSW				•	•
U_FLOE	UFW	•				
UMM	UM W	•				
VIENI	VE W	•	•			
TRES 2	TRES 2			•		



SKLEJKA/ SPERRHOLZ/ PLYWOOD

OKLEINA NATURALNA/ NATURFURNIER/ NATURAL VENEER

KLEJONKA DĘBOWA/ BRETTSCHICHTHOLZ AUS EICHE/ FINGER JOINT SOLID OAK

KLEJONKA SOSNOWA/ BRETTSCHICHTHOLZ AUS PINE/ FINGER JOINT SOLID PINE

SKLEJKA/ SPERRHOLZ/  
PLYWOOD

D1

naturalna  
natürliche  
natural

D3

bielona  
gebleichte  
bleachedOKLEINA NATURALNA/ NATURFURNIER/  
NATURAL VENEER

FDAB

dqb  
Eiche  
oak

FORZ

orzech amerykański  
amerikanischer Nussbaum  
American walnutKLEJONKA DĘBOWA/ BRETTSCHICHTHOLZ  
AUS EICHE/ FINGER JOINT SOLID OAK

KDAB

dqb / Eiche / oak

KLEJONKA SOSNOWA/ BRETTSCHICHTHOLZ  
AUS PINE / FINGER JOINT SOLID PINE

KSOS

sosna / Pine / pine



KOLEKCJA KOLLEKTION COLLECTION	MODEL MODELL MODEL	SKLEJKA SPERRHOLZ PLYWOOD			OKLEINA NATURFURNIER VENEER		KLEJONKA DĘBOWA	KLEJONKA SOSNOWA
		kubelek/ Schale/ schell	podłokietnik/ Armlehne/ armrest	pulpit/blat/ Schreibtischt desktop	orzec/ Nussbaum/ walnut	dąb/ kiefer/ oak	FINGER JOINT SOLID OAK BRETTSCHICHTHOLZ AUS EICHE	FINGER JOINT SOLID PINE BRETTSCHICHTHOLZ AUS PINE
BOOI	BOS CHAIR W, BO W 4C2, BO W 4Z2, BO W 4L2				•	•		
ORTE	OT 215	•						
	OT 220	•	•	•				
	OT 271	•						
	OT 270	•	•					
	OT 222-225	•						
	OT 4L , OT 2L						•	
	OT H/ HS	•						
	OT W H/ HS	•						
QUADRA	QD SBG						•	•
SAAR	SM SF, SM WW, SM CH, SM PH, SM PF						•	
SPIN	SNP, SNR, SNW						•	
SOCIAL SWING	SSD TB, SSR TB						•	
	SS CHAIR				•	•		
TREEHOUSE	TH, THW						•	•
	THS, THSW						•	•
ZIP	ZP 220		•	•				

SKLEJKA/ SPERRHOLZ/ PLYWOOD

OKLEINA NATURALNA/ NATURFURNIER/ NATURAL VENEER

KLEJONKA DĘBOWA/ BRETTSCHICHTHOLZ AUS EICHE/  
FINGER JOINT SOLID OAK

KLEJONKA SOSNOWA/ BRETTSCHICHTHOLZ AUS PINE/  
FINGER JOINT SOLID PINE

# BLATY/ PLATTE/ TABLETOPS



PLYTA LAMINOWANA - STANDARD / LAMINIERTE PLATTE - STANDARD / LAMINATED TABLETOP - STANDARD



D3798 CL

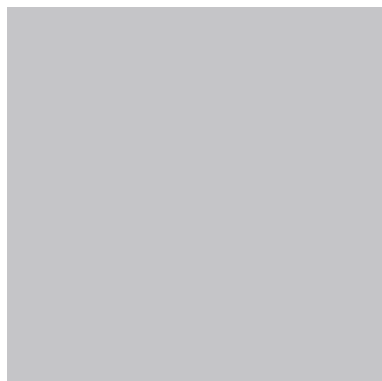

U112 VL

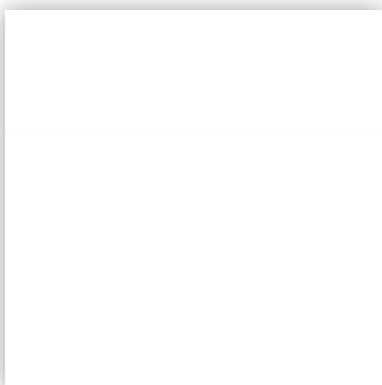

U570 VL



U164 VL

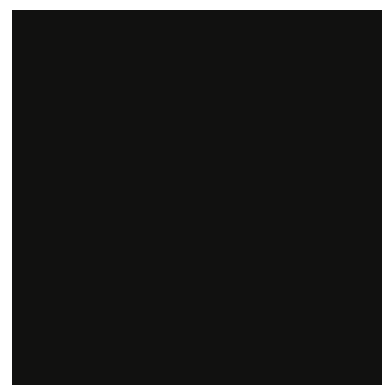

U190 VL

BLAT HPL / HPL PLATTE / HPL TABLETOP

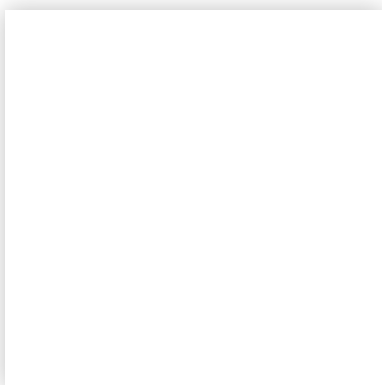

biały / Weiß / white

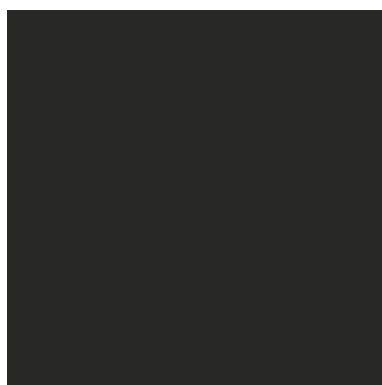

czarny niepalczący  
black anti finge print  
Schwarz nicht verschmutzendes

LAMINAT / LAMINATE / LAMINAT - ORTE

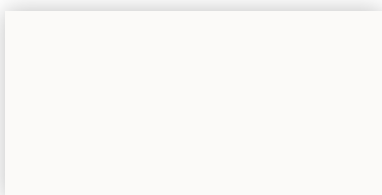

CPL  
biały / Weiß / white



CPL  
antracyt / Anthrazit / anthracity

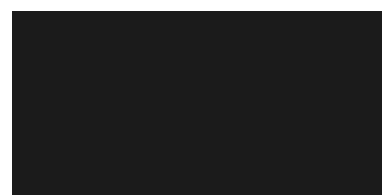

CPL  
czarny / Schwarz / black

				PLYTA LAMINOWANA LAMINIERTE PLATTE LAMINATED TABLETOP	HPL
kolekcja Kollektion collection	produkt Produkt product	długość Länge length [mm]	szerokość Breite width [mm]	grubość Dicke thickness [mm]	grubość Dicke thickness [mm]
ACOUSTIC PEAK	AP C1T	Fi 1000		18	10
	AP C2T	2000	1000	18	10
	AP TB	Fi 800		18	10
CAVE	CV TB L	910	800		10
	CV TB H	910	800		10
LEAF_POD	LP LTB, LP CT, LP TB PC			18	10
	LP TB PB			18	
LEGVAN	TS1	1300	700	18	
	TS2	700	700	18	
ORTE	OT 4L	1400	800	25	10
	OT 4L	1600	800	25	10
	OT 4L	2000	1000	25	10
	OT 2L Y	1350	675	25	
	OT 2L T	1350	675	25	
	OT W 4L AA	1400	800	25	10
	OT W 4L AA	1600	800	25	10
	OT W 4L AA	2000	1000	25	10
	OT W 4L AA H	1350	675	25	10
OT 4L A H	1350	675	25	10	
PENTA	PNT 600 B	920	845	18	
QUADRA	QD T690 B	690	690	18	
	QD TB3	1550	750	18	
	QD P1B	630	220	18	
SAAR	SM PF, SM PH, SM SF, SMWW, SM CH			18	
SPIN	SN W TB H	Fi 600		25	
SOCIAL SWING	SSD TB	570	500	18	10
	SSR TB	Fi 1000		25	10
TB	TB W 74 L	Fi 700		18	10
	TB W 74 H	Fi 560		18	10
	TB 29 L	775	670	18	10
	TB 29 H	500	500	18	10
	TB 29R L	Fi 700		18	10
	TB 29R H	Fi 460		18	10
	TB SQ 420	420	420	18	10
	TB SQ 570	570	570	18	10
	TB SQ 800	800	800	18	10
TB EP 1300	1300	570	18	10	
TREEHOUSE	TM	740	580		
	TH	740	580		10
	THD	1410	650	18	10
U_FLOE	UF TB	650	580	18	
	UF BOX+T	420	420		10
	UF TB 45/90/180/180C	660/990/600/600	580/600/600/600		10
	STEP_OVER H/L	1200	600	18	10
	STEP_OVER F	980	220		10
		1255	225		10
UNI	UNI R 460	Fi 460		18	10
	UNI R 560	Fi 560		18	10
	UNI R 700	Fi 700		18	10
VOO VOO	VV TS3	680	500	18	
	VV TS4	1300	700	18	
	VV TS5	700	700	18	
	VV TB3	1800	820	18	
	VV TBC3	1800	820	18	
	VV TB2	1200	820	18	
	VV TBC2	1200	820	18	
	VV WORK	455	340	18	

MOŻLIWOŚCI ZASTOSOWANIA TKANIN W POSZCZEGÓLNYCH PRODUKTACH  
 POSSIBILITIES OF USING FABRICS IN INDIVIDUAL PRODUCTS  
 VERFÜGBARKEIT VON STOFFEN FÜR EINZELNE PRODUKTE

● Kropka oznacza, że produkt występuje w danej tkaninie.  
 A point means that the product can be made in the fabric.  
 Das Produkt ist im angezeigten Stoff erhältlich.

	BOND	FENNO	KEIMO	NICE	SAWANA	CHARLES	ERA	FIGHTER	PASTEL	ROCCIA	SAWANA PIK	VALENCIA
ACOUSTIC PEAK	●	●	●			●		●	●	●		
BEACHHOUSE		●						●	●	●	●	
BOOI		●				●		●	●	●	●	●
BOOI WORKSTATION siedzisko/seat/Sitz		●				●		●	●	●	●	
BOOI WORKSTATION ścianka/wall/Wand		●			●	●		●	●	●	●	
CAVE modułowy/modular		●				●			●	●	●	
CAVE 9XX		●				●			●	●	●	
CEO												
CLUBIN	●	●	●		●	●		●	●	●	●	
CORR	●	●	●	●	●	●	●	●	●	●	●	●
CUBE	●	●	●		●	●		●	●	●	●	●
CUBE 3D	●	●	●		●			●	●	●		●
DUAL	●	●	●	●	●	●	●	●	●	●	●	●
EGGO	●	●	●	●	●	●	●	●	●	●	●	●
ELEVEN	●	●	●	●	●	●	●	●	●	●	●	●
EPOCC	●	●	●		●	●	●	●	●	●	●	●
FENDO	●	●	●		●	●		●	●	●	●	●
IN ACCESS		●	●		●	●		●	●	●	●	●
KYOS	●	●	●	●	●	●	●	●	●	●	●	●
LEAF_POD ścianka/wall/Wand												
LEAF_POD sofa/sofa	●	●	●		●	●	●	●	●	●	●	●
LEGVAN	●	●	●		●	●		●	●	●	●	●
LIFT	●	●	●	●	●	●	●	●	●	●	●	●
LUMI	●	●	●		●	●	●	●	●	●	●	●
MATE	●	●	●	●	●	●	●	●	●	●	●	●
MILLA	●	●	●	●	●	●	●	●	●	●	●	●
MOMO	●	●	●	●	●	●	●	●	●	●	●	●
MOMO 1T2	●	●						●	●	●		
MORK 2N	●	●	●	●	●	●	●	●	●	●	●	●
ORTE 2N/3N	●	●	●	●	●	●	●	●	●	●	●	●
ORTE 3D	●	●	●		●	●	●	●		●		●
ORTE 4N	●	●	●	●	●	●	●	●	●	●	●	●
OX:CO	●	●	●		●	●	●	●	●	●	●	●

1 grupa cenowa / price group / Preisgruppe

2 grupa cenowa / price group / Preisgruppe

MOŻLIWOŚCI ZASTOSOWANIA TKANIN W POSZCZEGÓLNYCH PRODUKTACH  
 POSSIBILITIES OF USING FABRICS IN INDIVIDUAL PRODUCTS  
 VERFÜGBARKEIT VON STOFFEN FÜR EINZELNE PRODUKTE

● Kropka oznacza, że produkt występuje w danej tkaninie.  
 A point means that the product can be made in the fabric.  
 Das Produkt ist im angezeigten Stoff erhältlich.

VALENCIA SD	BLAZER	CRISP	FAME	SILVERTEX	SYNERGY	REMIX	SKÓRA LEATHER LEDER	HERITAGE	ACCESSOIRE	STEELCUT		
	●	●	●		●	●				●	ACOUSTIC PEAK	
	●	●	●		●	●				●	BEACHHOUSE	
●	●	●	●		●	●	●	●		●	BOOI	
	●	●	●		●	●	●	●		●	BOOI WORKSTATION siedzisko/seat/Sitz	
	●	●	●		●	●		●		●	BOOI WORKSTATION ścianka/wall/Wand	
	●	●	●		●	●			●	●	CAVE modułowy/modular	
	●	●	●		●	●	●	●	●	●	CAVE 9XX	
	●	●	●		●	●	●				CEO	
	●	●	●	●	●	●	●	●	●	●	CLUBIN	
●	●	●	●	●	●	●	●	●	●	●	CORR	
●	●	●	●	●	●	●	●	●	●	●	CUBE	
●	●	●	●	●	●	●	●				CUBE 3D	
●	●	●	●	●	●	●	●	●		●	DUAL	
●	●	●	●	●	●	●	●	●	●	●	EGGO	
●	●	●	●	●	●	●	●	●	●	●	ELEVEN	
●	●	●	●	●	●	●	●	●	●	●	EPOCC	
●	●	●	●	●	●	●	●	●		●	FENDO	
●	●	●	●	●	●	●	●	●	●	●	IN ACCESS	
●	●	●	●	●	●	●	●	●	●	●	KYOS	
	●				●						LEAF_POD ścianka/wall/Wand	
●	●	●	●	●	●	●	●	●	●	●	LEAF_POD sofa/sofa	
●	●	●	●	●	●	●	●	●	●	●	LEGVAN	
●	●	●	●	●	●	●	●	●	●	●	LIFT	
●	●	●	●	●	●	●	●	●	●	●	LUMI	
●	●	●	●	●	●	●	●	●	●	●	MATE	
●	●	●	●	●	●	●	●	●	●	●	MILLA	
●	●	●	●	●	●	●	●	●	●	●	MOMO	
		●				●		●		●	MOMO 1T2	
●	●	●	●	●	●	●	●	●	●	●	MORK 2N	
●	●	●	●	●	●	●	●	●	●	●	ORTE 2N/3N	
●	●	●		●	●	●	●				ORTE 3D	
●	●	●	●	●	●	●	●	●		●	ORTE 4N	
●	●	●	●	●	●	●	●	●	●	●	OX:CO	
3 grupa cenowa / price group / Preisgruppe						4 grupa cenowa / price group / Preisgruppe			5 grupa cenowa / price group / Preisgruppe			

MOŻLIWOŚCI ZASTOSOWANIA TKANIN W POSZCZEGÓLNYCH PRODUKTACH  
 POSSIBILITIES OF USING FABRICS IN INDIVIDUAL PRODUCTS  
 VERFÜGBARKEIT VON STOFFEN FÜR EINZELNE PRODUKTE

● Kropka oznacza, że produkt występuje w danej tkaninie.  
 A point means that the product can be made in the fabric.  
 Das Produkt ist im angezeigten Stoff erhältlich.

	BOND	FENNO	KEIMO	NICE	SAWANA	CHARLES	ERA	FIGHTER	PASTEL	ROCCIA	SAWANA PIK	VALENCIA
PENTA	●	●	●		●	●		●	●	●	●	●
PENTA ścianka/wall/Wand	●	●			●	●		●	●	●	●	
POINT	●	●	●		●	●		●	●	●	●	●
POINT 3D	●	●	●		●	●		●	●	●		●
QUADRA	●	●	●		●	●		●	●	●	●	●
QUADRA PHONEBOX	●	●			●	●		●	●	●		
QUADRA SHA		●						●	●	●	●	
QUADRA ścianka/wall/Wand	●	●			●	●		●	●	●	●	
QUADRA STANDING BOX GLASS		●				●		●	●	●	●	
SAAR	●	●	●	●	●	●	●	●	●	●	●	●
ROLLWALL	●	●	●		●	●		●	●	●	●	
SELVA DESK / HANG / FREE / SKY / WALL	●	●			●	●	●	●	●	●	●	
SELVA POD / TOWER	●	●			●	●		●	●	●	●	
SHELL	●	●	●	●	●	●	●	●	●	●	●	●
SILENT BLOCK	●	●			●	●	●	●	●	●	●	
SKY_LINE	●	●	●	●	●	●	●	●	●	●	●	●
SOCIAL SWING siedzisko/seat/Sitz	●	●	●		●	●	●	●	●	●	●	
SOCIAL SWING DOUBLE / ROUND	●	●			●			●	●	●		
SOCIAL SWING ławka/bench/Bank	●	●	●		●	●		●	●	●	●	
SPIN SNR / SNR LU	●	●	●	●	●	●	●	●	●	●	●	●
STRING	●	●	●	●	●	●	●	●	●	●	●	●
TREEHOUSE		●				●		●	●	●	●	●
TREEHOUSE ścianka tylna / back wall / Rückwand		●						●	●	●	●	●
TREEHOUSE STAND SINGLE 2G		●				●		●	●	●	●	
TREEHOUSE DOUBLE GLASS 1G		●				●		●	●	●	●	
U_FLOE	●	●	●		●	●		●	●	●	●	●
U_FLOE ścianka/wall/Wand	●	●			●	●		●	●	●	●	
UMM		●				●		●	●	●		
VECTOR	●	●	●		●	●		●	●	●	●	●
VIENI		●				●		●	●	●		●
VOO VOO		●	●		●	●			●	●	●	●
VOO VOO 9xx / 9xx Box		●	●		●	●			●	●	●	●
ZIP	●	●	●	●	●	●	●	●	●	●	●	●

1 grupa cenowa / price  
group / Preisgruppe

2 grupa cenowa / price  
group / Preisgruppe

MOŻLIWOŚCI ZASTOSOWANIA TKANIN W POSZCZEGÓLNYCH PRODUKTACH  
 POSSIBILITIES OF USING FABRICS IN INDIVIDUAL PRODUCTS  
 VERFÜGBARKEIT VON STOFFEN FÜR EINZELNE PRODUKTE

● Kropka oznacza, że produkt występuje w danej tkaninie.  
 A point means that the product can be made in the fabric.  
 Das Produkt ist im angezeigten Stoff erhältlich.

VALENCIA SD	BLAZER	CRISP	FAME	SILVERTEX	SYNERGY	REMIX	SKÓRA LEATHER LEDER	HERITAGE	ACCESSOIRE	STEELCUT		
●	●	●	●	●	●	●	●	●	●	●	PENTA	
	●	●	●		●	●				●	PENTA ścianka/wall/Wand	
●	●	●	●	●	●	●	●	●	●	●	POINT	
●	●	●	●	●	●	●	●				POINT 3D	
●	●	●	●	●	●	●	●	●	●	●	QUADRA	
	●	●	●		●	●				●	QUADRA PHONEBOX	
	●	●	●		●	●				●	QUADRA SHA	
	●	●	●		●	●				●	QUADRA ścianka/wall/Wand	
	●	●	●		●	●				●	QUADRA STANDING BOX GLASS	
●	●	●	●	●	●	●	●	●	●	●	SAAR	
	●	●	●		●	●			●	●	ROLLWALL	
	●	●	●		●	●		●	●	●	SELVA DESK / HANG / FREE / SKY / WALL	
	●	●	●		●	●		●		●	SELVA POD / TOWER	
●	●	●	●	●	●	●	●	●	●	●	SHELL	
	●	●	●		●	●		●	●	●	SILENT BLOCK	
●	●	●	●	●	●	●	●	●	●	●	SKY_LINE	
	●	●	●	●	●	●	●	●		●	SOCIAL SWING siedzisko/seat/Sitz	
	●	●	●		●	●				●	SOCIAL SWING DOUBLE / ROUND	
	●	●	●		●	●		●		●	SOCIAL SWING ławka/bench/Bank	
●	●	●	●	●	●	●	●	●	●	●	SPIN SNR / SNR LU	
●	●	●	●	●	●	●	●	●	●	●	STRING	
●	●	●	●	●	●	●			●	●	TREEHOUSE	
●	●	●	●	●	●	●				●	TREEHOUSE ścianka tylna / back wall / Rückwand	
	●	●	●		●	●		●	●	●	TREEHOUSE STAND SINGLE 2G	
	●	●	●		●	●		●	●	●	TREEHOUSE DOUBLE GLASS 1G	
●	●	●	●	●	●	●	●	●	●	●	U_FLOE	
	●	●	●		●	●				●	U_FLOE ścianka/wall/Wand	
	●	●	●		●	●	●	●		●	UMM	
●	●	●	●	●	●	●	●	●	●	●	VECTOR	
●	●	●	●	●	●	●	●	●	●	●	VIENI	
●	●	●		●	●	●	●	●		●	VOO VOO	
●	●	●		●	●	●	●			●	VOO VOO 9xx / 9xx Box	
●	●	●	●	●	●	●	●	●	●	●	ZIP	
3 grupa cenowa / price group / Preisgruppe						4 grupa cenowa / price group / Preisgruppe			5 grupa cenowa / price group / Preisgruppe			





RAL 3005  
M - mat/matte/mat



RAL 3020  
P - połysk/gloss/Glanz



RAL 2001  
M - mat/matte/mat



miedz/copper\*\*  
P - połysk/gloss/Glanz

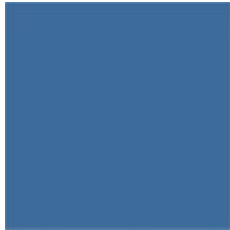

RAL 5007  
M - mat/matte/mat



RAL 5003  
M - mat/matte/mat



RAL 6005  
M - mat/matte/mat



gold  
P - połysk/gloss/Glanz

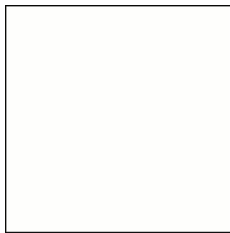

RAL 9010  
P - połysk/gloss/Glanz  
S\* - struktura/structure/  
Struktur

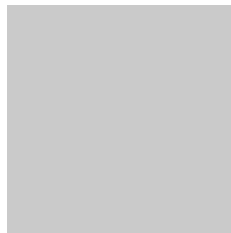

RAL 7047  
P - połysk/gloss/Glanz  
M - mat/matte/mat  
S\* - struktura/structure/  
Struktur

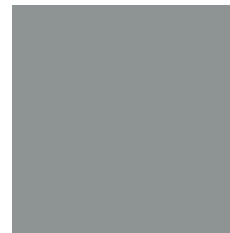

RAL 7045  
P - połysk/gloss/Glanz  
M - mat/matte/mat  
S\* - struktura/structure/  
Struktur

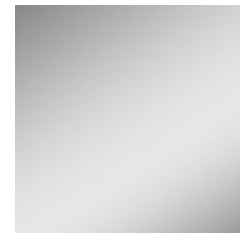

alu  
P - połysk/gloss/Glanz

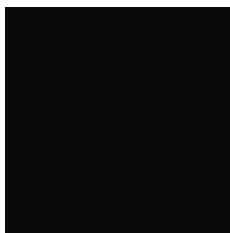

RAL 9005  
M - mat/matte/mat  
S - struktura/structure/  
Struktur



RAL 7024  
P - połysk/gloss/Glanz  
M - mat/matte/mat  
S\* - struktura/structure/  
Struktur



chrom

**Stolik TB OUT**

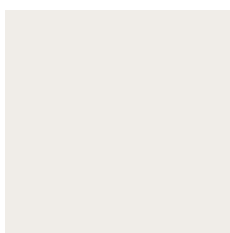

0500



5540



8010

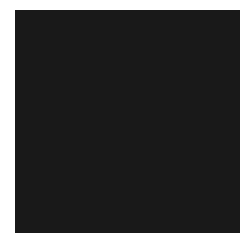

9000

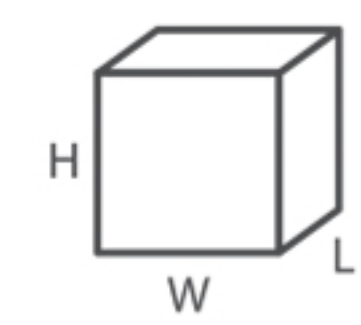
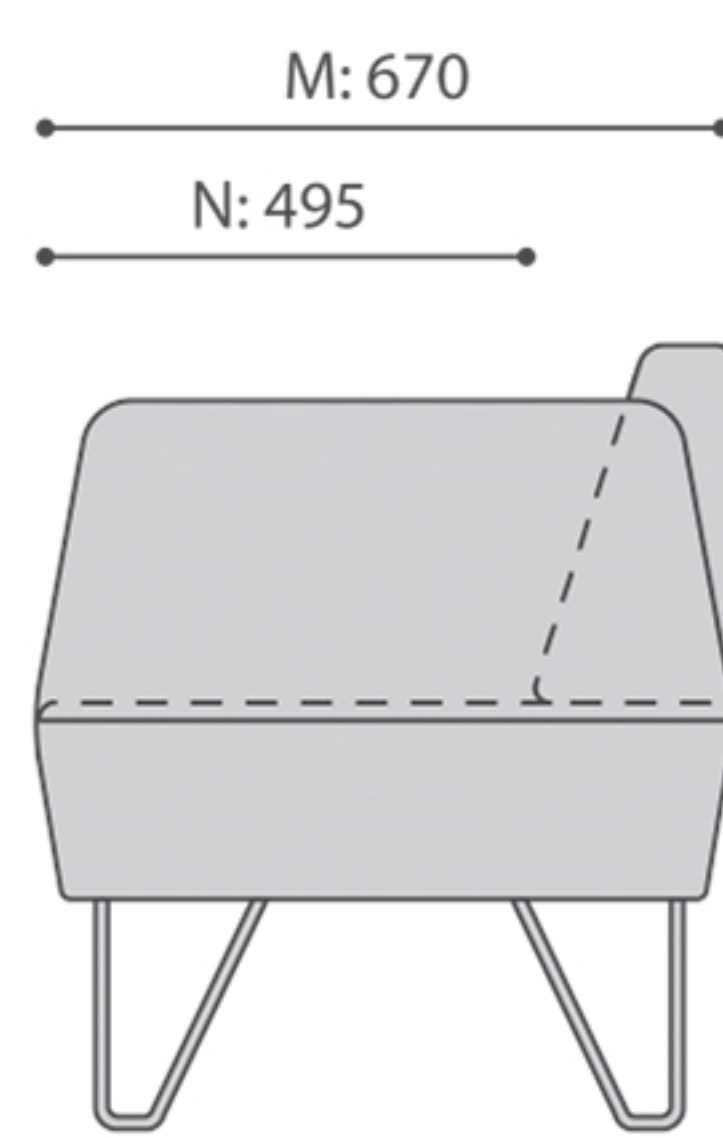
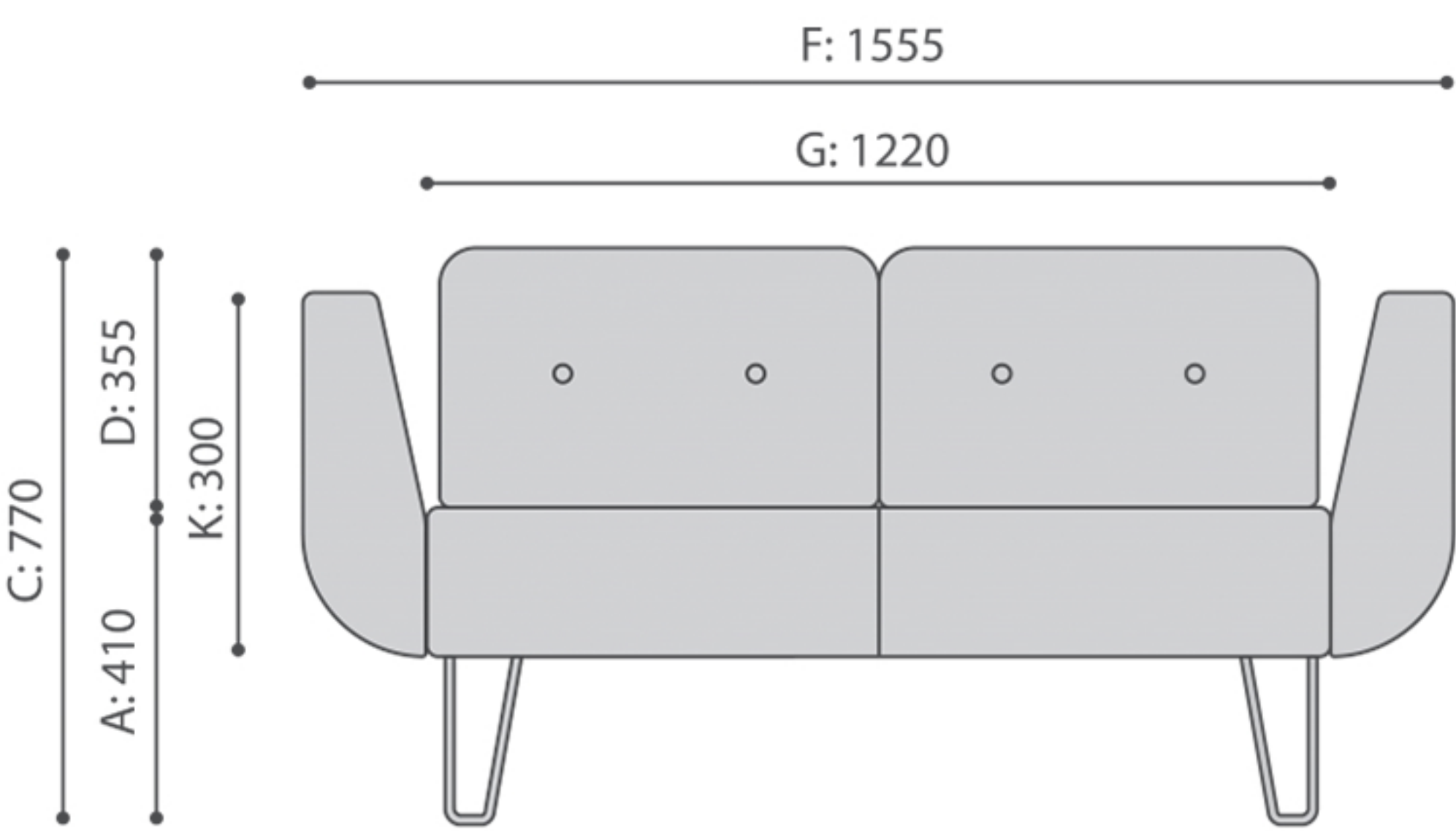

H: 690  
W: 1580  
L: 800

1 szt.  
St.  
pc.



42,5

## UF2211

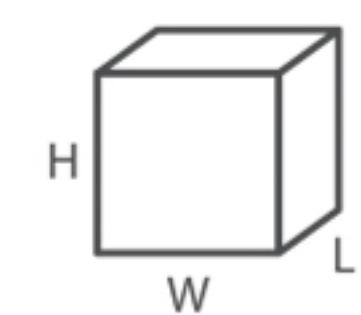
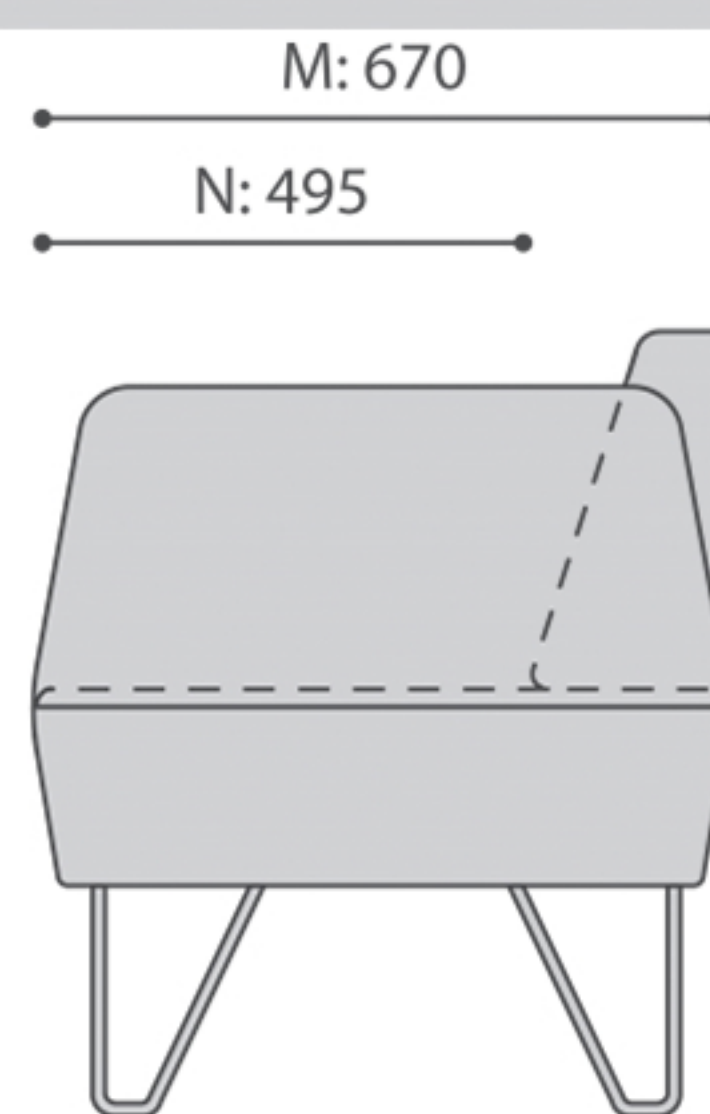
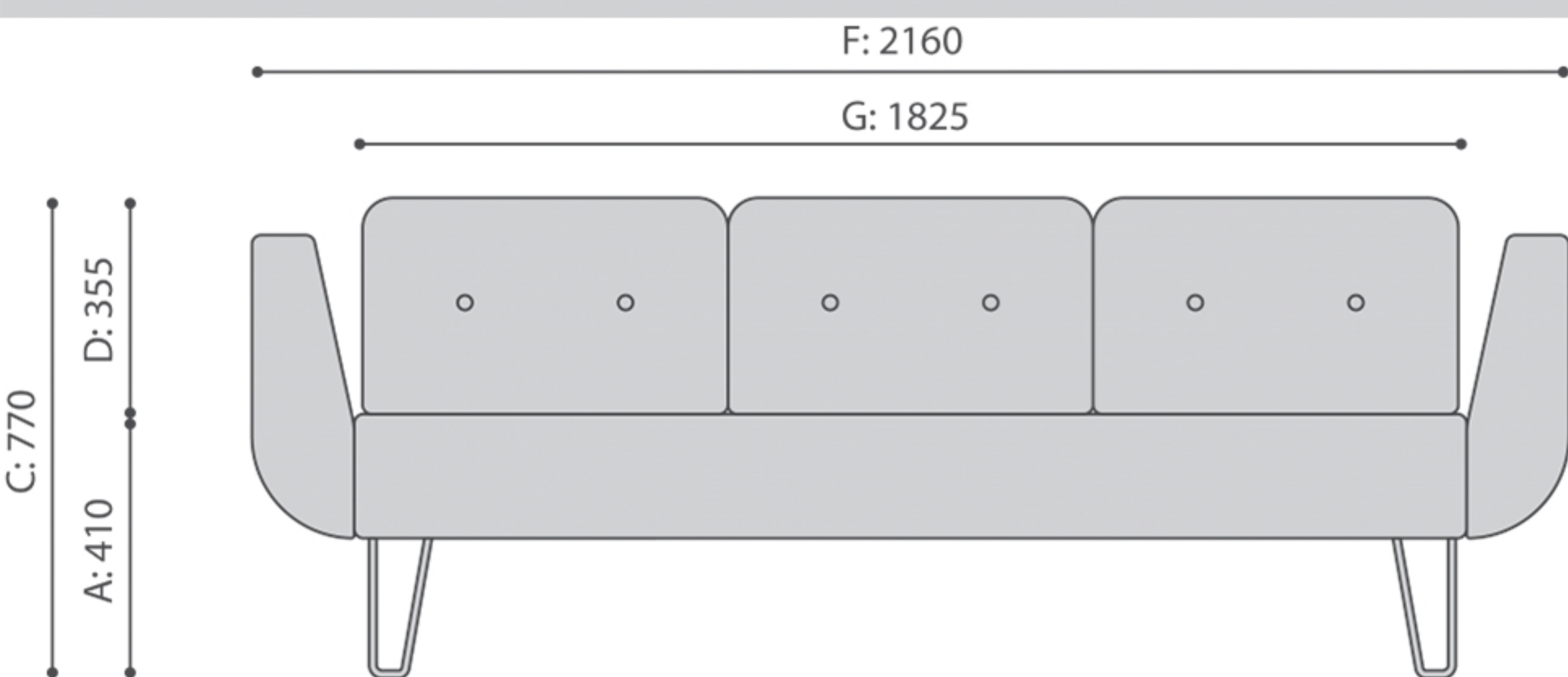

H: 690  
W: 2180  
L: 800

1 szt.  
St.  
pc.



55

## UF32111

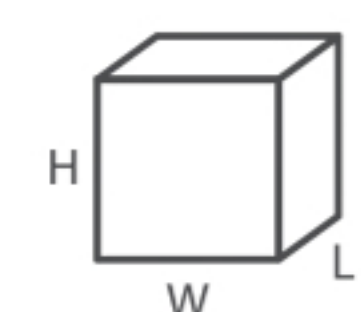
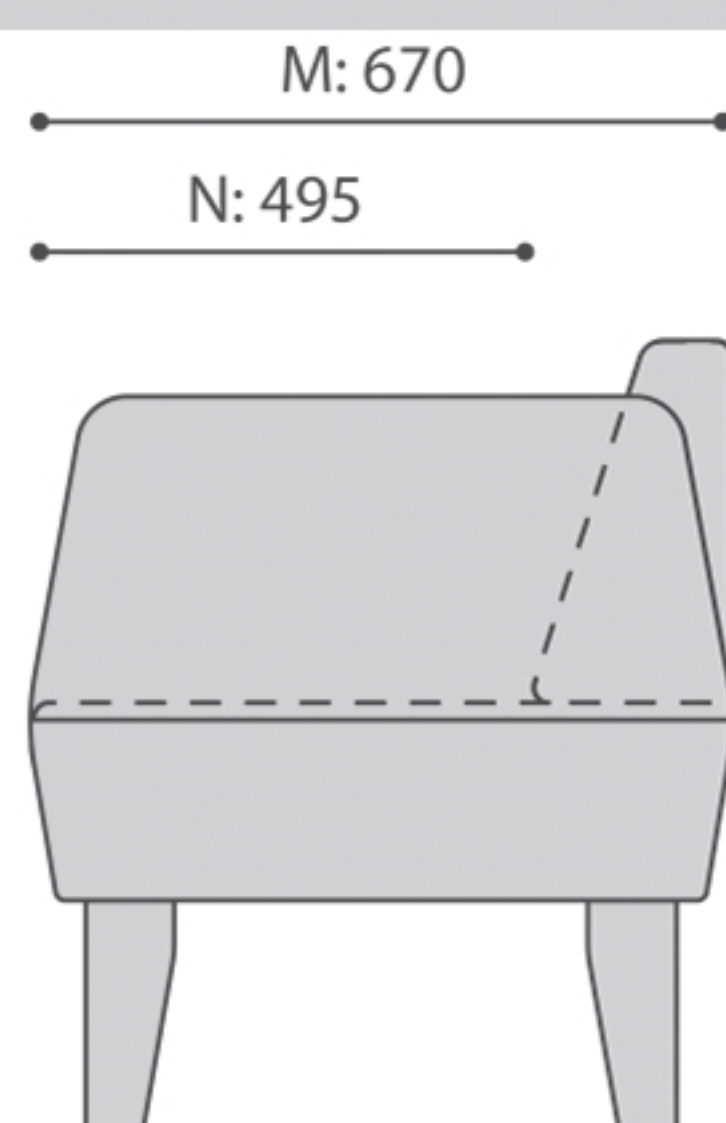
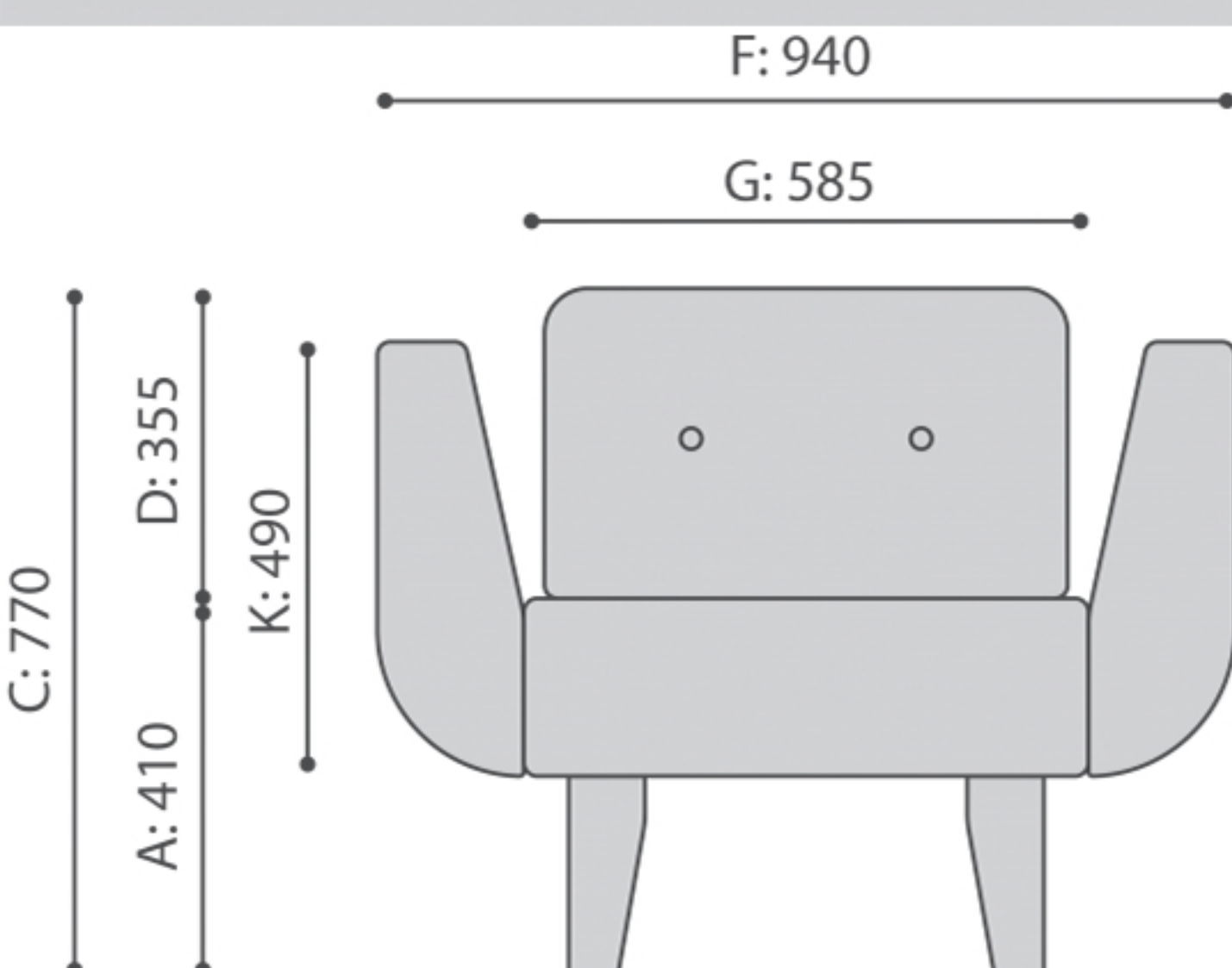

H: 690  
W: 960  
L: 800

1 szt.  
St.  
pc.



30

## UFW121

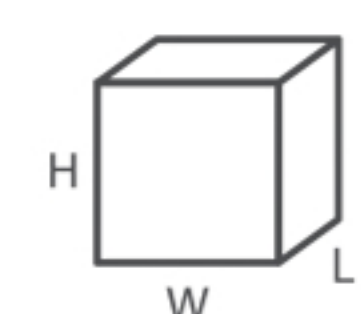
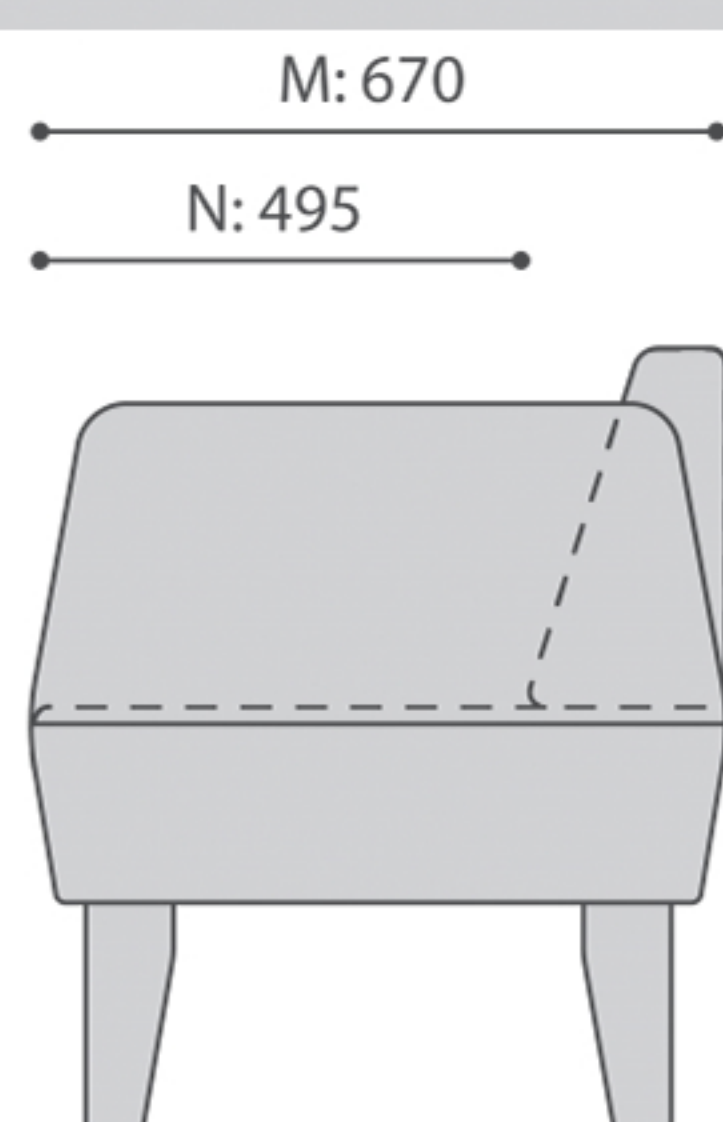
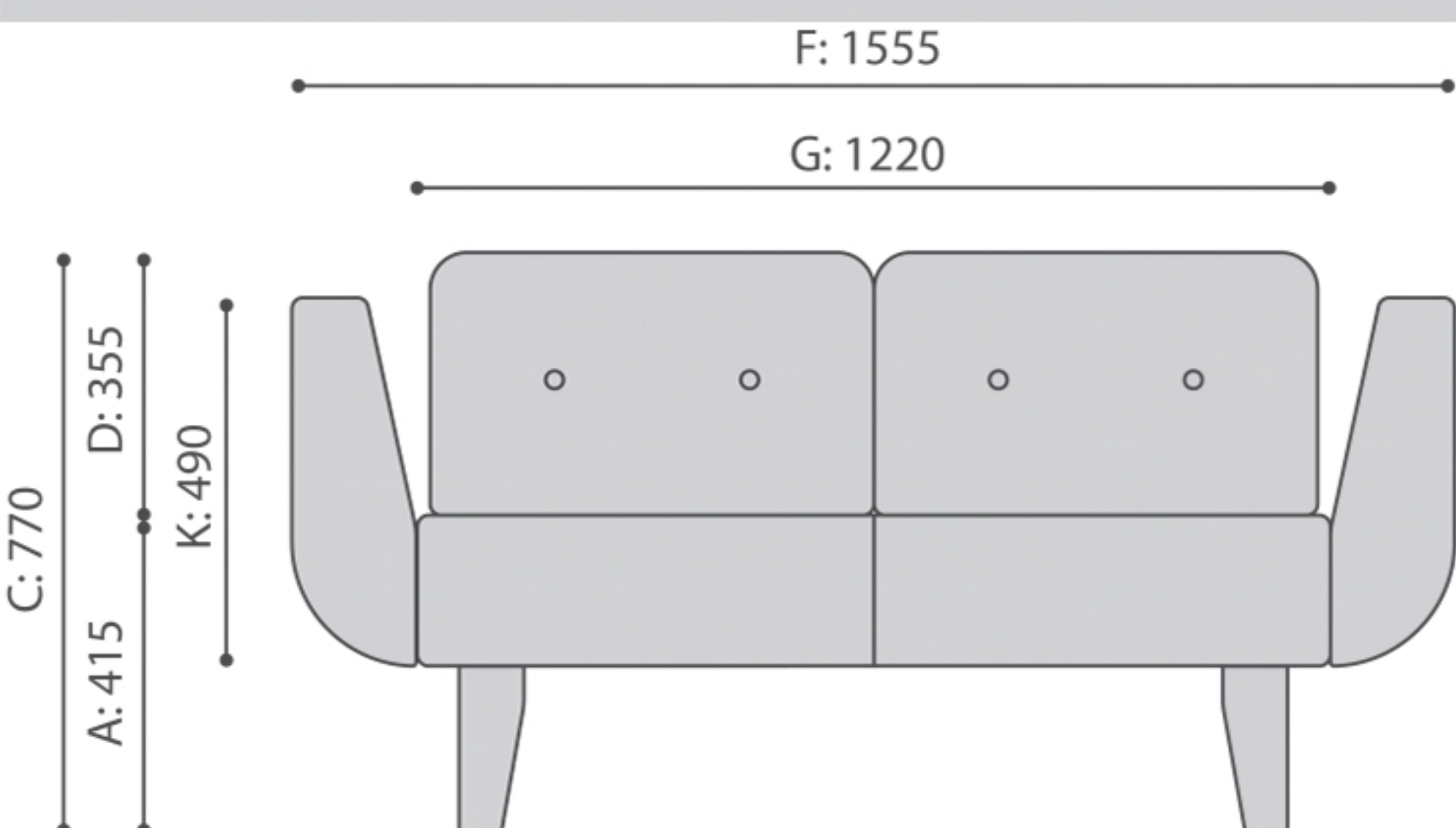

H: 690  
W: 1580  
L: 800

1 szt.  
St.  
pc.



43,5

## UFW2211

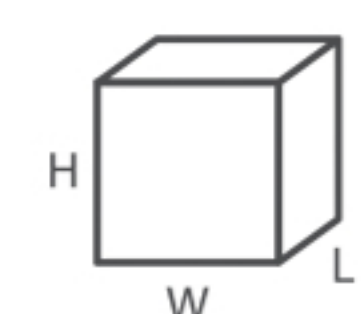
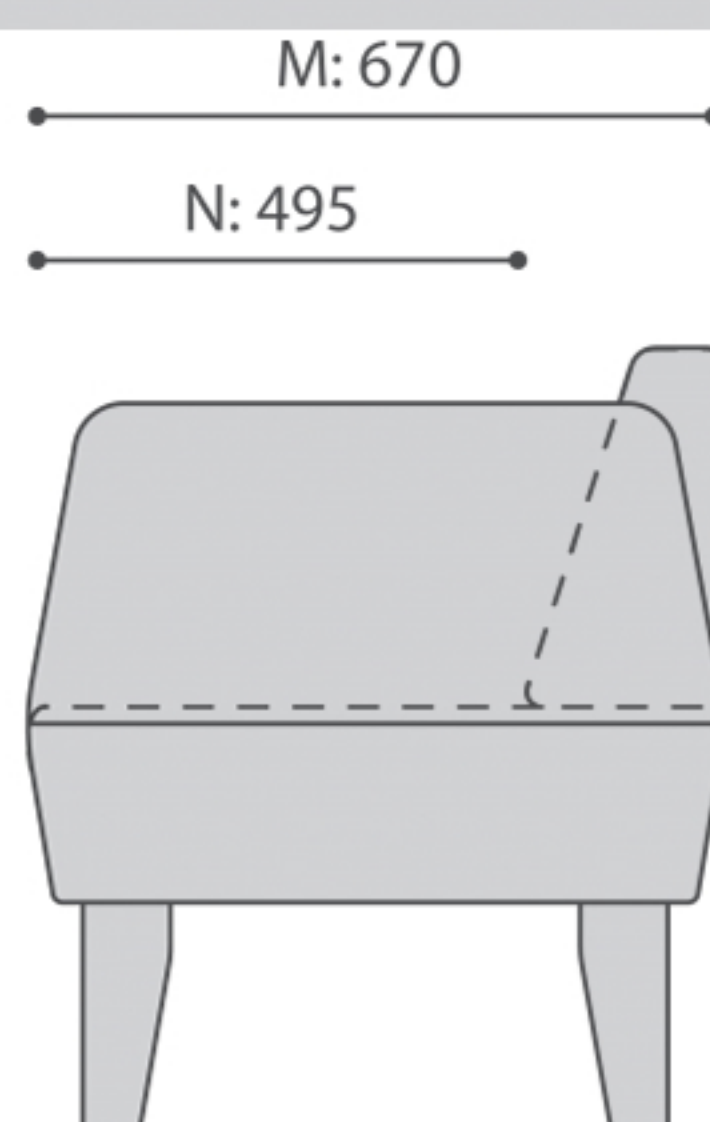
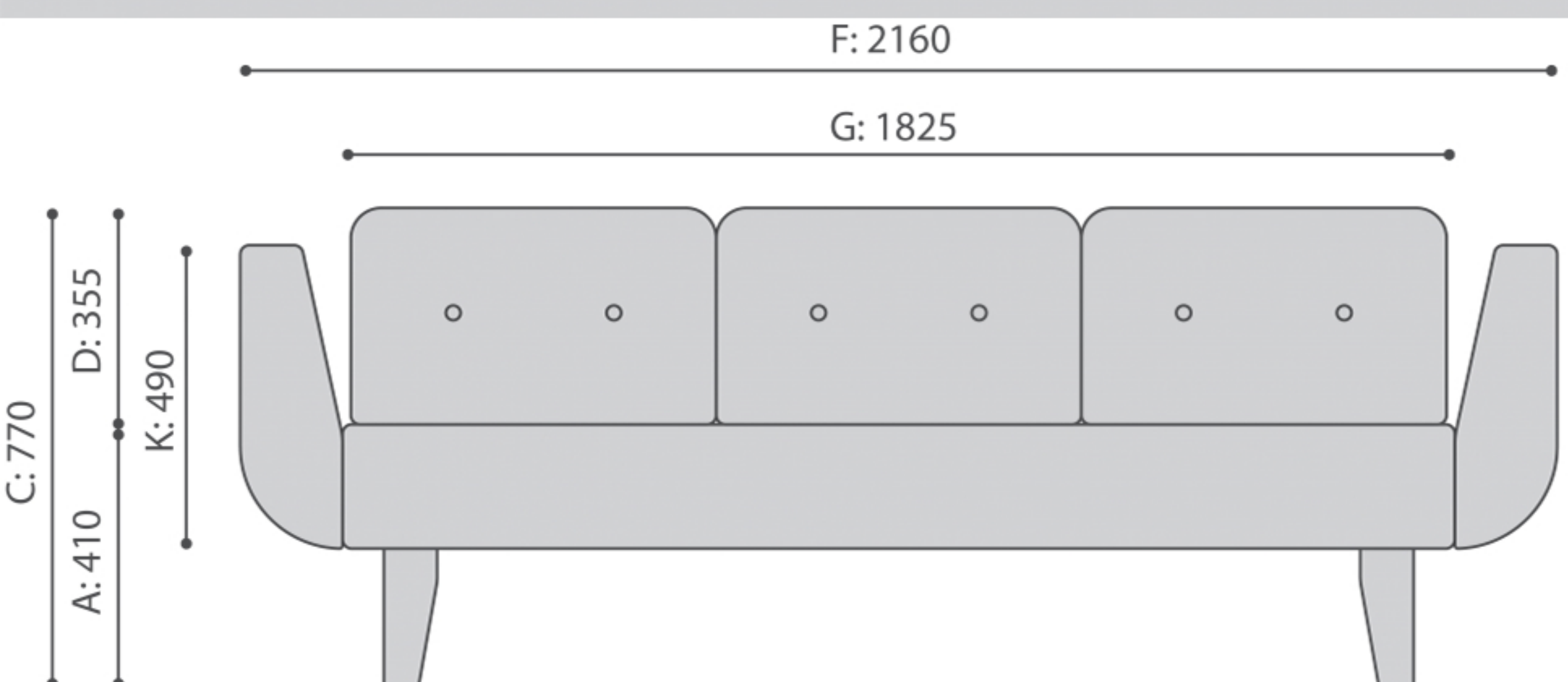

H: 690  
W: 2180  
L: 800

1 szt.  
St.  
pc.



56,5

## UFW32111

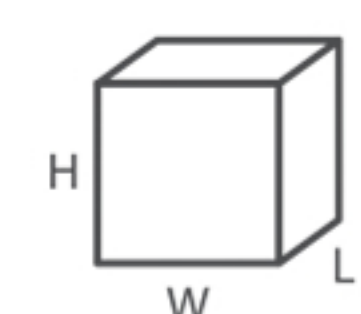
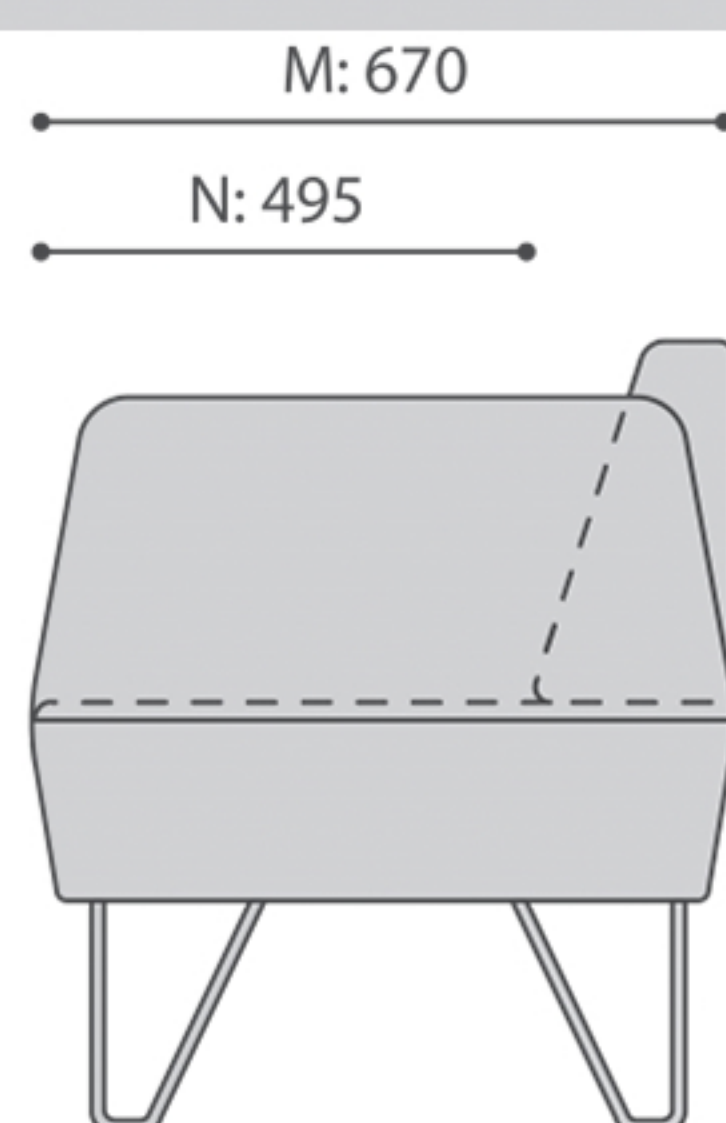
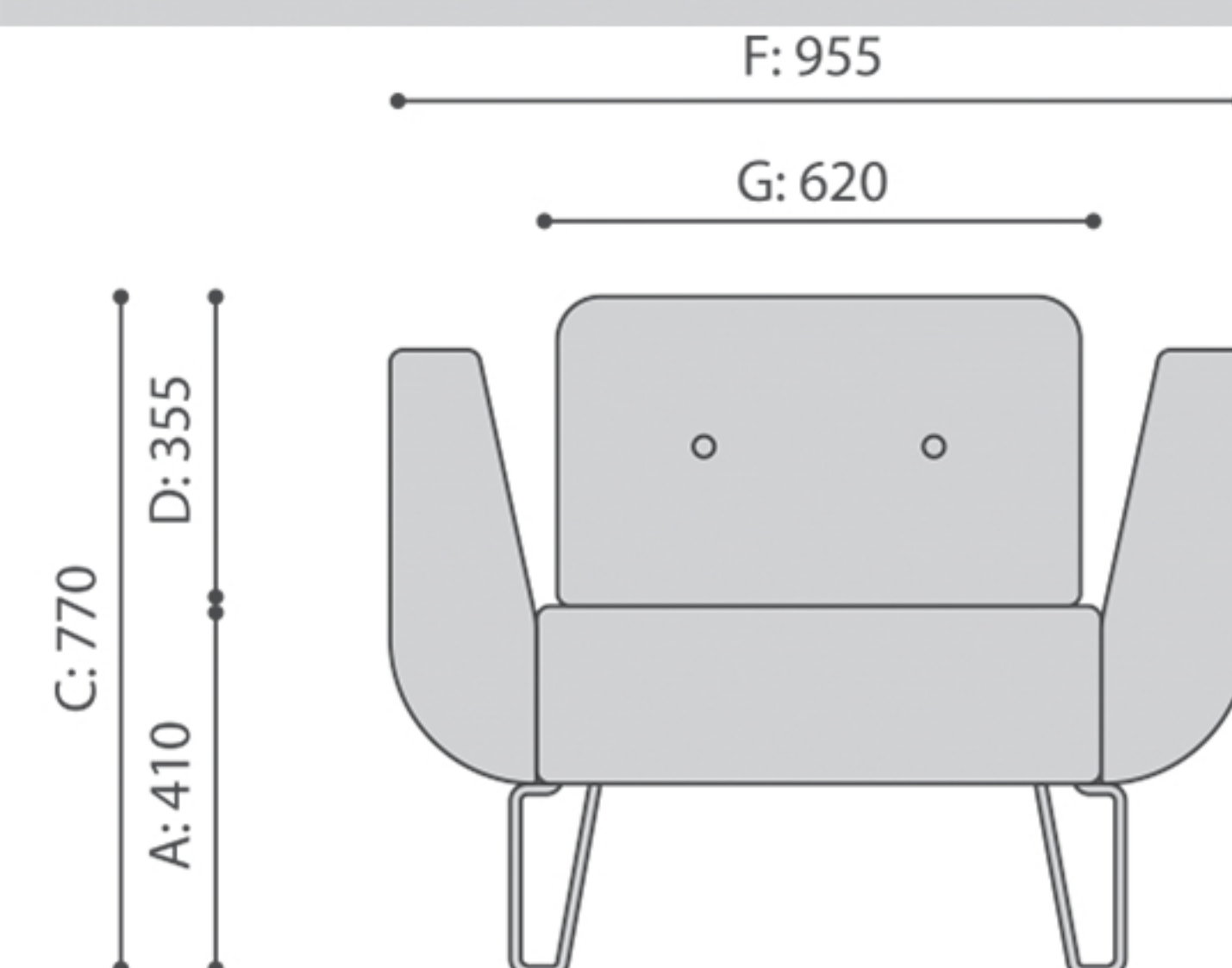

H: 690  
W: 960  
L: 800

1 szt.  
St.  
pc.



29,5

## UF121