

1 grupa cenowa
1. Preisgruppe
1st price group



BD 005



BD 012



BD 078



BD 048



BD 021

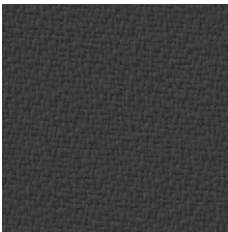

BD 033



BD 023



BD 011



BD 004



BD 003

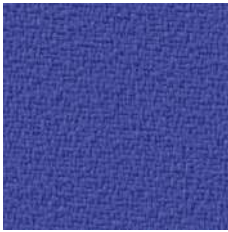

BD 071



BD 006



BD 008



BD 036

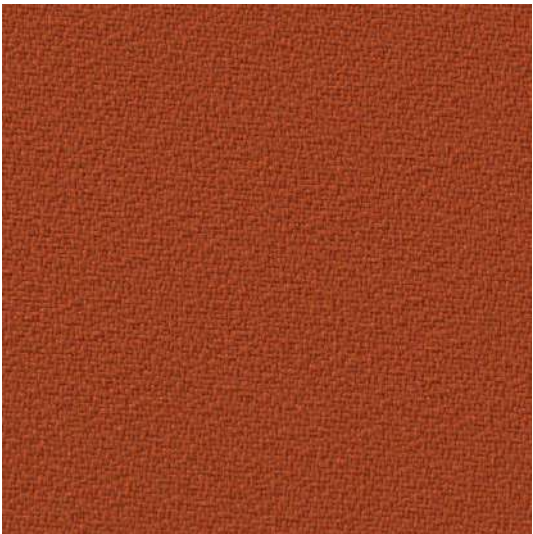

BD 013

**PL**

Skład
100% Poliester

Waga
250 g/m² ± 5%

Szerokość rolki
140 cm

Odporność na ścieranie
150 000 cykli Martindale
(UNI EN ISO 12947/2):2017

Pilling
5 (UNI EN ISO 12945/2):2002

Odporność na światło
7 (EN ISO 105-B02):2014

Certyfikaty trudnopalności
-BS EN 1021-1:2014
-BS EN 1021-2:2014
-BS 5852:2006 (CRIB 5)
-BS 7176:2007 (Medium Hazard)
-UNI 9175 (1987) 1 IM

DE

Zusammensetzung
100% Polyester

Gewicht
250 g/m² ± 5%

Rollenbreite
140 cm

Scheuerfestigkeit
150 000 Zyklen Martindale
(UNI EN ISO 12947/2):2017

Pilling
5 (UNI EN ISO 12945/2):2002

Lichtechtheit
7 (EN ISO 105-B02):2014

Feuersicherung
-BS EN 1021-1:2014
-BS EN 1021-2:2014
-BS 5852:2006 (CRIB 5)
-BS 7176:2007 (Medium Hazard)
-UNI 9175 (1987) 1 IM

EN

Composition
100% Polyester

Weight
250 g/m² ± 5%

Roll width
140 cm

Abrasion Resistance
150 000 Martindale cycles
(UNI EN ISO 12947/2):2017

Pilling
5 (UNI EN ISO 12945/2):2002

Light Fastness
7 (EN ISO 105-B02):2014

Flammability
-BS EN 1021-1:2014
-BS EN 1021-2:2014
-BS 5852:2006 (CRIB 5)
-BS 7176:2007 (Medium Hazard)
-UNI 9175 (1987) 1 IM





FN 019



FN 020



FN 018



FN 017



FN 016



FN 015



FN 014



FN 013

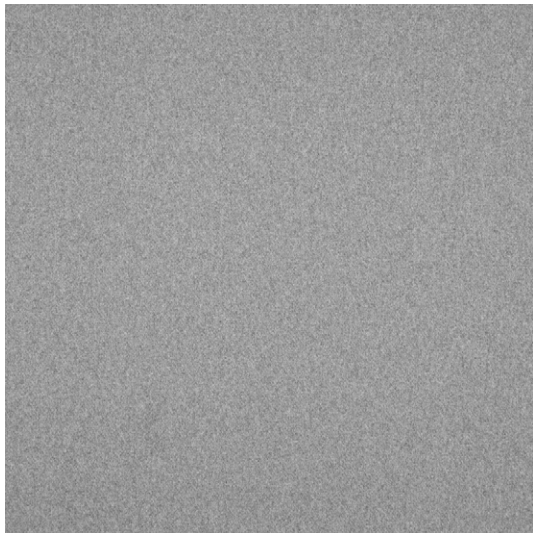

FN 005

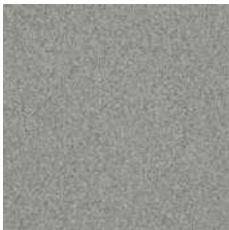

FN 001



FN 002



FN 004

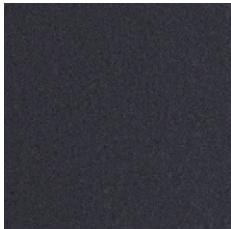

FN 012

PL**Skład**

100% Poliester

Waga402g/m²**Szerokość rolki**

144 cm

Odporność na ścieranie100 000 cykli Martindale
(EN ISO 12947-2)**Pilling**

4 (EN ISO 12945-2)

Odporność na światło

5 (EN ISO 105-B02:2014)

Odporność koloru na tarcie

Mokre: 4-5 (UNI EN ISO 105-X12)

Suche: 4-5 (UNI EN ISO 105-X12)

Certyfikaty trudnopalności

-BS 5852: Part 1:1979

Ignition Source 0 (Papieros)

DE**Zusammensetzung**

100% Polyester

Gewicht402g/m²**Rollenbreite**

144 cm

Scheuerfestigkeit100 000 Zyklen Martindale
(EN ISO 12947-2)**Pilling**

4 (EN ISO 12945-2)

Lichtechtheit

5 (EN ISO 105-B02:2014)

Reibechtheit

Nass: 4-5 (UNI EN ISO 105-X12)

Trocken: 4-5 (UNI EN ISO 105-X12)

Feuersicherung

-BS 5852: Part 1:1979

Ignition Source 0 (Zigarette)

EN**Composition**

100% Polyester

Weight402g/m²**Roll width**

144 cm

Abrasion Resistance100 000 Martindale cycles
(EN ISO 12947-2)**Pilling**

4 (EN ISO 12945-2)

Light Fastness

5 (EN ISO 105-B02:2014)

Fastness to Rubbing

Wet: 4-5 (UNI EN ISO 105-X12)

Dry: 4-5 (UNI EN ISO 105-X12)

Flammability

-BS 5852: Part 1:1979

Ignition Source 0 (Cigarette)

apretura wodoodporna
wasserdichtes Finish
water repellent



KA 085



KA 006



KA 210



KA 143

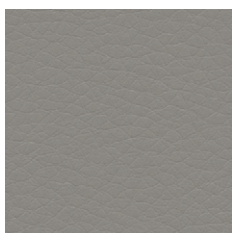

KA 710



KA 740

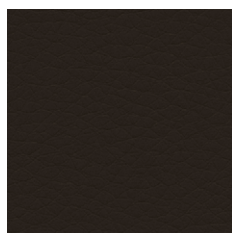

KA 250



KA 040



KA 009



KA 050



KA 032



KA 429



KA 035

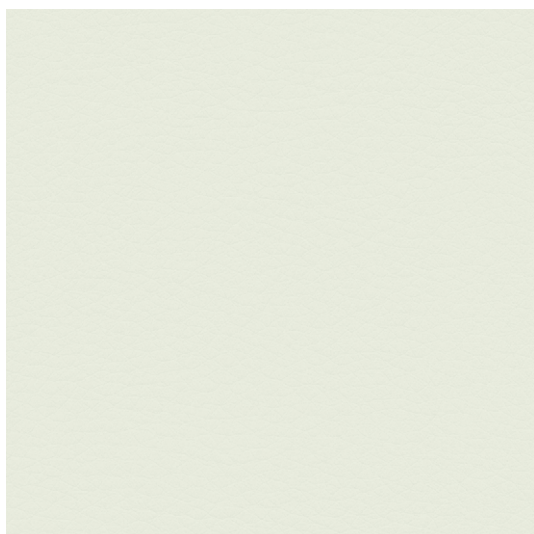

KA 003



KA 120



KA 755



KA 045



KA 780

PL

Powłoka
100% PU

Nośnik
65% Poliester, 35% Bawełna

Waga
420 g/m² ± 10%

Szerokość rolki
142 cm ± 2 cm

Odporność na ścieranie
100,000 ± 5% cykli Martindale
(UNI EN ISO 5470-2 method 1)

Odporność na światło
>5 (ISO 105-B02)

Odporność koloru na tarcie
Mokre: 5 (UNI EN ISO 105-X12)
Suche: 5 (UNI EN ISO 105-X12)

Certyfikaty trudnopalności
-BS 5852/DIN EN 1021-1:2014

DE

Oberfläche
100% PU

Gewebe
65% Polyester, 35% Baumwolle

Gewicht
420 g/m² ± 10%

Rollenbreite
142 cm ± 2 cm

Scheuerfestigkeit
100,000 ± 5% Zyklen Martindale
(UNI EN ISO 5470-2 method 1)

Lichtechtheit
>5 (ISO 105-B02)

Reibechtheit
Nass: 5 (UNI EN ISO 105-X12)
Trocken: 5 (UNI EN ISO 105-X12)

Feuersicherung
-BS 5852/DIN EN 1021-1:2014

EN

Surface
100% PU

Basic material
65% Polyester, 35% Cotton

Weight
420 g/m² ± 10%

Roll width
142 cm ± 2 cm

Abrasion Resistance
100,000 ± 5% Martindale cycles
(UNI EN ISO 5470-2 method 1)

Light Fastness
>5 (ISO 105-B02)

Fastness to Rubbing
Wet: 5 (UNI EN ISO 105-X12)
Dry: 5 (UNI EN ISO 105-X12)

Flammability
-BS 5852/DIN EN 1021-1:2014



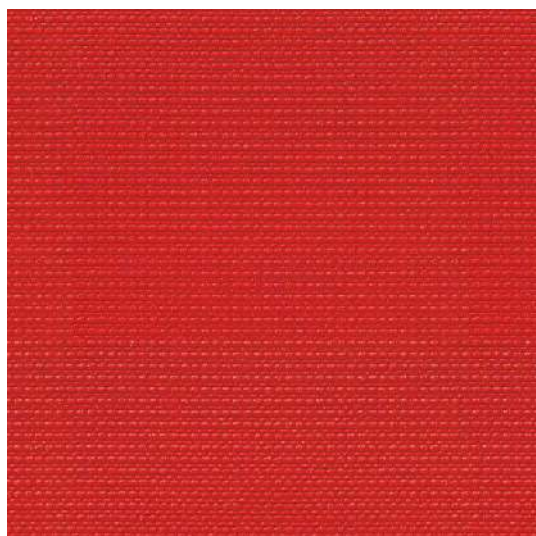

NC 075



NC 072



NC 069



NC 049

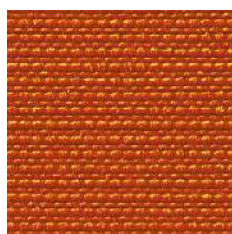

NC 074



NC 029



NC 067

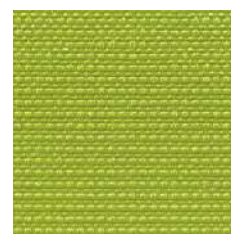

NC 078

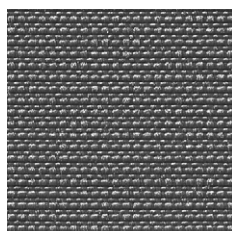

NC 046



NC 050



NC 012



NC 077



NC 076



NC 550



NC 549

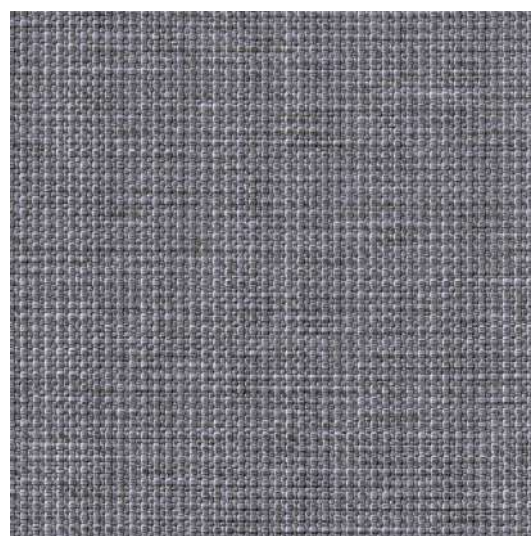

NC 546

PL**Skład**

100% Poliester

Waga366 g/m² ± 15 g**Szerokość rolki**

140 cm

Odporność na ścieranie140 000 ± 5% cykli Martindale
(PN-EN 14465: 2005/ A1:2007)**Pilling**

4-5 (UNI EN ISO 12945-2:2002)

Odporność na światło

3-4 (PN - EN ISO 105-B02: 2013)

Odporność koloru na tarcieMokre: 4-5 (PN-EN ISO 105 X12:2005)
Suche: 4-5 (PN-EN ISO 105 X12:2005)**Certyfikaty trudnopalności**-PN-EN 1021-1: 2007
-PN-EN 1021-2: 2007**DE****Zusammensetzung**

100% Polyester

Gewicht366 g/m² ± 15 g**Rollenbreite**

140 cm

Scheuerfestigkeit140 000 ± 5% Zyklen Martindale
(PN-EN 14465: 2005/ A1:2007)**Pilling**

4-5 (UNI EN ISO 12945-2:2002)

Lichtechtheit

3-4 (PN - EN ISO 105-B02: 2013)

ReibechtheitNass: 4-5 (PN-EN ISO 105 X12:2005)
Trocken: 4-5 (PN-EN ISO 105 X12:2005)**Feuersicherung**-PN-EN 1021-1: 2007
-PN-EN 1021-2: 2007**EN****Composition**

100% polyester

Weight366 g/m² ± 15 g**Roll width**

140 cm

Abrasion Resistance140 000 ± 5% Martindale cycles
(PN-EN 14465: 2005/ A1:2007)**Pilling**

4-5 (UNI EN ISO 12945-2:2002)

Light Fastness

3-4 (PN - EN ISO 105-B02: 2013)

Fastness to RubbingWet: 4-5 (PN-EN ISO 105 X12:2005)
Dry: 4-5 (PN-EN ISO 105 X12:2005)**Flammability**-PN-EN 1021-1: 2007
-PN-EN 1021-2: 2007

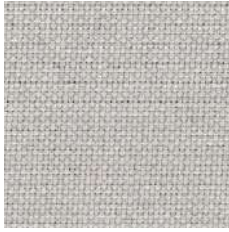

SN 084

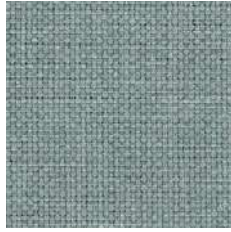

SN 072

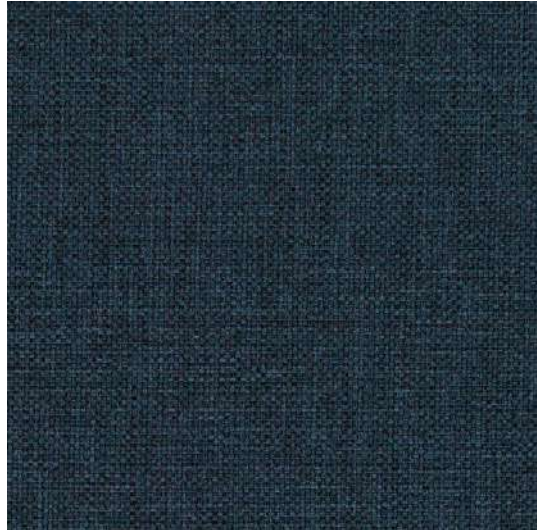

SN 080

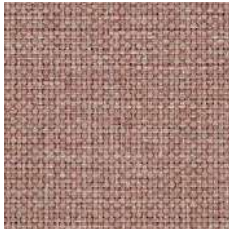

SN 061



SN 017



SN 069



SN 011



SN 031



SN 034



SN 021



SN 005



SN 014

PL

Skład
100% Poliester

Waga
245g/m² ± 5%

Szerokość rolki
140 cm

Odporność na ścieranie
70,000 cykli Martindale
(BS EN ISO 12947-2:1999)

Pilling
4-5 (DIN EN ISO 12945/2:2000)

Odporność na światło
4 (EN ISO 105-B02:2013)

Odporność koloru na tarcie
Mokro: 4 (UNI EN ISO 105-X12:2016)
Sucho: 4-5 (UNI EN ISO 105-X12:2016)

Certyfikaty trudnopalności
-DIN EN 1021-1

DE

Zusammensetzung
100% polyester

Gewicht
245g/m² ± 5%

Rollenbreite
140 cm

Scheuerfestigkeit
70,000 Zyklen Martindale
(BS EN ISO 12947-2:1999)

Pilling
4-5 (DIN EN ISO 12945/2:2000)

Lichtechtheit
4 (EN ISO 105-B02:2013)

Reibechtheit
Nass: 4 (UNI EN ISO 105-X12:2016)
Trocken: 4-5 (UNI EN ISO 105-X12:2016)

Feuersicherung
-DIN EN 1021-1

EN

Composition
100% Polyester

Weight
245g/m² ± 5%

Roll width
140 cm

Abrasion Resistance
70,000 Martindale cycles
(BS EN ISO 12947-2:1999)

Pilling
4-5 (DIN EN ISO 12945/2:2000)

Light Fastness
4 (EN ISO 105-B02:2013)

Fastness to Rubbing
Wet: 4 (UNI EN ISO 105-X12:2016)
Dry: 4-5 (UNI EN ISO 105-X12:2016)

Flammability
-DIN EN 1021-1





2 grupa cenowa
2. Preisgruppe
2nd price group



CH 030



CH 022



CH 024



CH 041



CH 044



CH 045



CH 006



CH 009



CH 004



CH 005



CH 038



CH 040

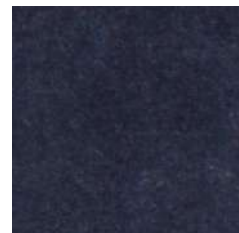

CH 002



CH 034



CH 033



CH 001

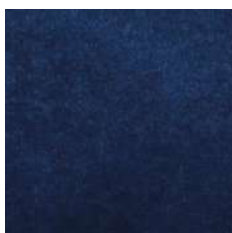

CH 032

PL

Skład:
100% Poliester

Waga:
433 g/m²

Szerokość rolki:
140cm

Odporność na ścieranie:
90 000 cykli Martindale'a
(BS EN ISO 12947-2:2000)

Pilling:
5 (EN ISO 12 945-2:2000)

Odporność na światło:
5 (ISO 105-B02)

Odporność koloru na tarcie:
Mokre: 4-5 (UNI EN ISO 105-X12)
Suche: 4-5 (UNI EN ISO 105-X12)

Certyfikaty trudnopalności:
-DIN EN 1021-1

DE

Zusammensetzung:
100% Polyester

Gewicht:
433 g/m²

Rollenbreite:
140cm

Scheuerfestigkeit:
90 000 Zyklen Martindale
(BS EN ISO 12947-2:2000)

Pilling:
5 (EN ISO 12 945-2:2000)

Lichtechtheit
5 (ISO 105-B02)

Reibechtheit
Nass: 4-5 (UNI EN ISO 105-X12)
Trocken: 4-5 (UNI EN ISO 105-X12)

Feuersicherung:
-DIN EN 1021-1

EN

Composition:
100% Polyester

Weight:
433 g/m²

Roll width:
140cm

Abrasion Resistance
90 000 Martindale cycles
(BS EN ISO 12947-2:2000)

Pilling:
5 (EN ISO 12 945-2:2000)

Light Fastness
5 (ISO 105-B02)

Fastness to Rubbing
Wet: 4-5 (UNI EN ISO 105-X12)
Dry: 4-5 (UNI EN ISO 105-X12)

Flammability:
-DIN EN 1021-1

- Tkanina Charles ze względu na strukturę (długi włos), podczas użytkowania może układać się w charakterystyczny dla tkanin welurowy sposób, tworząc wrażenie różnych odcieni tapicerki.
- Der Stoff Charles kann aufgrund seiner Struktur (langes Haar) im Gebrauch veloursartig angeordnet werden, wodurch der Eindruck von verschiedenen Polstertönen entsteht.
- Charles fabric, due to its structure (long hair), can be arranged in a velour way while being used, creating the impression of different shades of upholstery.



apretura wodoodporna
wasserdichtes Finish
water repellent

Przedstawiona kolorystyka nie stanowi oferty w rozumieniu prawa.
Vorgestellte Farbgebung ist kein Angebot im Sinne der Rechtsvorschriften.
The colors presented do not constitute an offer within the meaning of law.

**CHARLES**

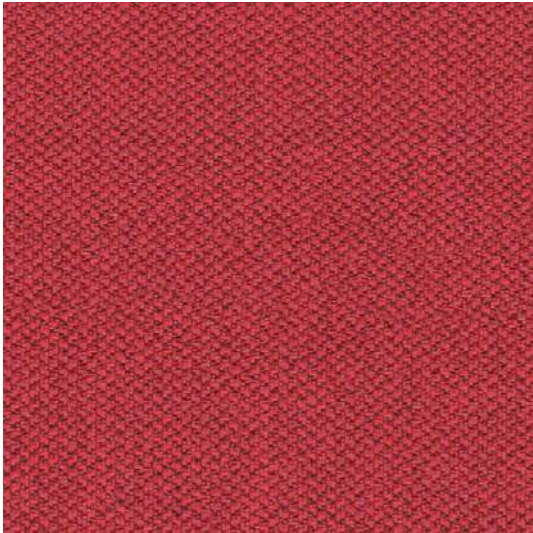

CSE 06

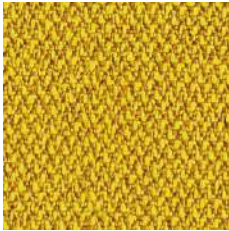

CSE 32

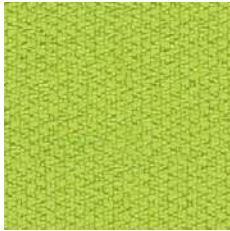

CSE 07

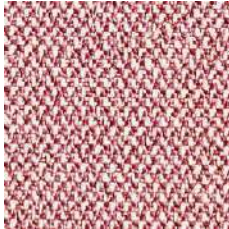

CSE 24

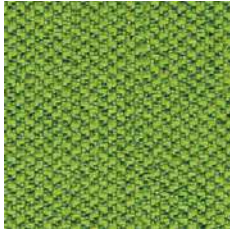

CSE 16

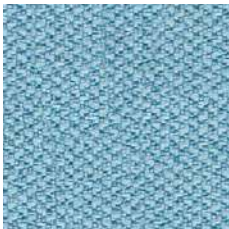

CSE 20

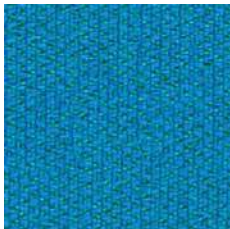

CSE 10



CSE 35

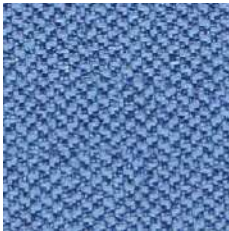

CSE 08



CSE 12



CSE 40



CSE 11



CSE 13



CSE 41



CSE 44

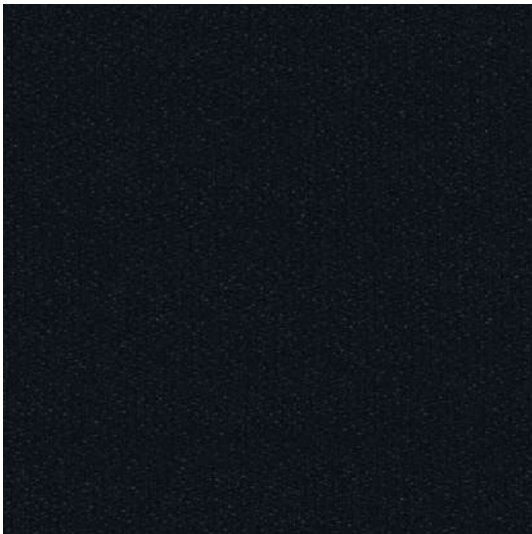

CSE 14

PL**Skład**

100% Poliester
nie zawiera barwników metalicznych

Waga

320g/m² ± 5%
(448g/mb ±5%)

Szerokość rolki

140 cm

Odporność na ścieranie

≥ 100 000 cykli Martindale'a
(BS EN ISO 12947-2:2016)

Odporność na światło

6 (ISO 105-B02):2013

Odporność koloru na tarcie

Mokre: 5 (AAT CC-8-2013)
Suche: 4 (AAT CC-8-2013)

Certyfikaty trudnopalności

-BS EN 1021-1:2014
-BS EN 1021-2:2014
-BS 7176 Low Hazard

DE**Zusammensetzung**

100% Polyester
Nicht schwermetallhaltige Farbstoffe

Gewicht

320g/m² ± 5%
(448g/lfd ±5%)

Rollenbreite

140 cm

Scheuerfestigkeit

≥ 100 000 Zyklen Martindale
(BS EN ISO 12947-2:2016)

Lichtechtheit

6 (ISO 105-B02):2013

Reibechtheit

Nass: 5 (AAT CC-8-2013)
Trocken: 4 (AAT CC-8-2013)

Feuersicherung

-BS EN 1021-1:2014
-BS EN 1021-2:2014
-BS 7176 Low Hazard

EN**Composition**

100% Polyester
Non metallic dyestuffs

Weight

320g/m² ± 5%
(448g/lin.m ±5%)

Roll width

140 cm

Abrasion Resistance

≥ 100 000 Martindale cycles
(BS EN ISO 12947-2:2016)

Light Fastness

6 (ISO 105-B02):2013

Fastness to Rubbing

Wet: 5 (AAT CC-8-2013)
Dry: 4 (AAT CC-8-2013)

Flammability

-BS EN 1021-1:2014
-BS EN 1021-2:2014
-BS 7176 Low Hazard



G 0095



G 0069



G 0081

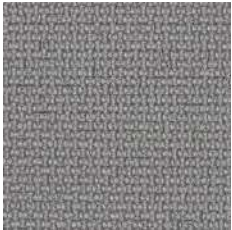

G 0082



G 0044



G 0070



G 0682



G 0083



G 0102



G 0683



G 0099

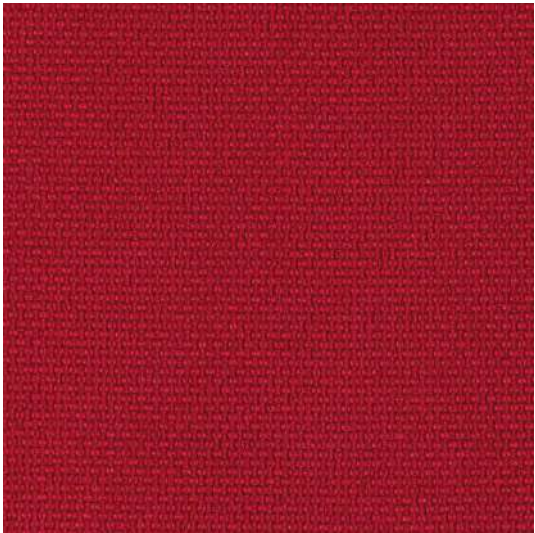

G 0003

PL

Skład
100% Poliester

Waga
365g/m²

Szerokość rolki
140 cm

Odporność na ścieranie
150 000 cykli Martindale
(EN ISO 12947-2-1998)/AC 2008
według BS EN 14465:2003

Pilling
4-5 (UNI EN ISO 12945/2):2000

Odporność na światło
6-7 (ISO 105-B02: 2014) Method 2

Odporność koloru na tarcie:
Mokre: 4-5 (UNI EN ISO 105-X12)
Suche: 5 (UNI EN ISO 105-X12)

Certyfikaty trudnopalności
-BS EN 1021-1 2014
-BS EN 1021-2 2014
-BS 5852 Part1: 1979
-UNI 9175:2010 Class 11M

DE

Zusammensetzung
100% Polyester

Gewicht
365g/m²

Rollenbreite
140 cm

Scheuerfestigkeit
150 000 Zyklen Martindale
(EN ISO 12947-2-1998)/AC 2008
gemäß BS EN 14465:2003

Pilling
4-5 (UNI EN ISO 12945/2):2000

Lichtechtheit
6-7 (ISO 105-B02: 2014) Method 2

Reibechtheit
Nass: 4-5 (UNI EN ISO 105-X12)
Trocken: 5 (UNI EN ISO 105-X12)

Feuersicherung
-BS EN 1021-1 2014
-BS EN 1021-2 2014
-BS 5852 Part1: 1979
-UNI 9175:2010 Class 11M

EN

Composition
100% Polyester

Weight
365g/m²

Roll width
140 cm

Abrasion Resistance
150 000 Martindale cycles
(EN ISO 12947-2-1998)/AC 2008
according to BS EN 14465:2003

Pilling
4-5 (UNI EN ISO 12945/2):2000

Light Fastness
6-7 (ISO 105-B02: 2014) Method 2

Fastness to Rubbing
Wet: 4-5 (UNI EN ISO 105-X12)
Dry: 5 (UNI EN ISO 105-X12)

Flammability
-BS EN 1021-1 2014
-BS EN 1021-2 2014
-BS 5852 Part1: 1979
-UNI 9175:2010 Class 11M





PA 527

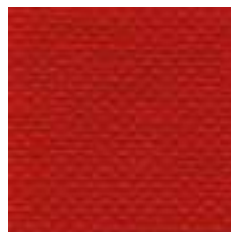

PA 010

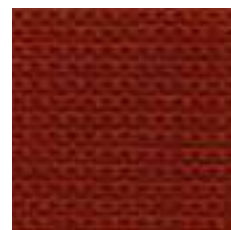

PA 511



PA 930



PA 020

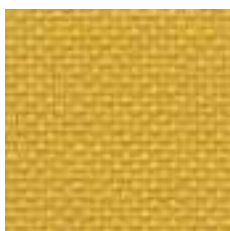

PA 390



PA 352



PA 531



PA 533



PA 153



PA 030

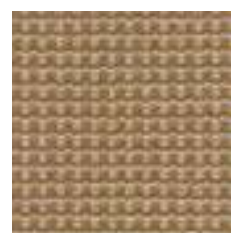

PA 532

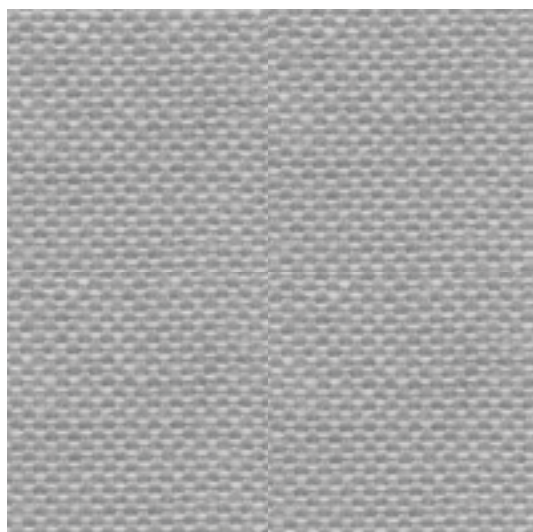

PA 854



PA 060



PA 560

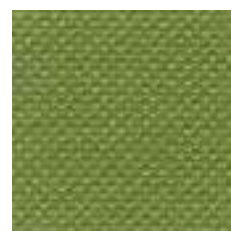

PA 065



PA 814

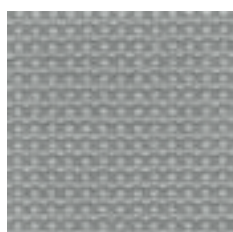

PA 555



PA 565

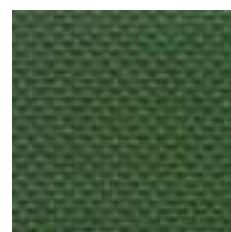

PA 736

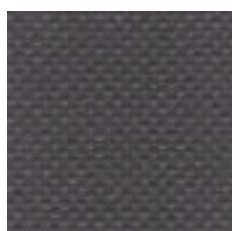

PA 810

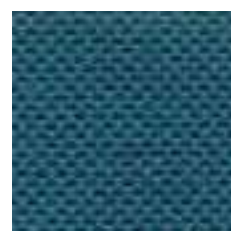

PA 653

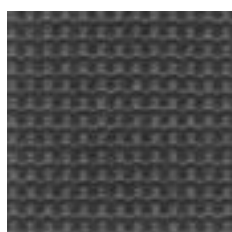

PA 571



PA 570



PA 050



PA 550

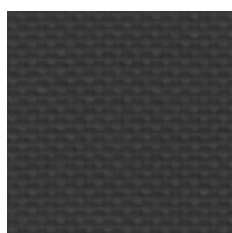

PA 833



PA 040



PA 541

PL**Skład**

100% Poliester Trevira CS®

Waga

260g/m² ± 5%

Szerokość rolki

140 cm

Odporność na ścieranie

70 000 cykli Martindale
(EN ISO 12947-2:2000)

Pilling

5 (ISO 12945-2:2002)

Odporność koloru na tarcie:

Mokro: 5 (ISO 105-X12:2016)
Sucho: 5 (ISO 105-X12:2016)

Odporność na światło

6-7 (EN ISO 105-B02:2014)

Certyfikaty trudnopalności

- BS EN 1021-1:2006
- BS EN 1021-2:2006
- BS 5852 : 2006 (Crib 5)
- BS 7176 Medium Hazard
- NF P92 503-507 (M1)
- DIN 4102-1 (B1)
- IMO A 652 (16) part 8

DE**Zusammensetzung**

100% Polyester Trevira CS®

Gewicht

260g/m² ± 5%

Rollenbreite

140 cm

Scheuerfestigkeit

70 000 Zyklen Martindale
(EN ISO 12947-2:2000)

Pilling

5 (ISO 12945-2:2002)

Reibechtheit

Nass: 5 (ISO 105-X12:2016)
Trocken: 5 (ISO 105-X12:2016)

Lichtechtheit

6-7 (EN ISO 105-B02:2014)

Feuersicherung

- BS EN 1021-1:2006
- BS EN 1021-2:2006
- BS 5852 : 2006 (Crib 5)
- BS 7176 Medium Hazard
- NF P92 503-507 (M1)
- DIN 4102-1 (B1)
- IMO A 652 (16) part 8

EN**Composition**

100% Polyester Trevira CS®

Weight

260g/m² ± 5%

Roll width

140 cm

Abrasion Resistance

70 000 Martindale cycles
(EN ISO 12947-2:2000)

Pilling

5 (ISO 12945-2:2002)

Fastness to Rubbing

Wet: 5 (ISO 105-X12:2016)
Dry: 5 (ISO 105-X12:2016)

Light Fastness

6-7 (EN ISO 105-B02:2014)

Flammability

- BS EN 1021-1:2006
- BS EN 1021-2:2006
- BS 5852 : 2006 (Crib 5)
- BS 7176 Medium Hazard
- NF P92 503-507 (M1)
- DIN 4102-1 (B1)
- IMO A 652 (16) part 8

**PASTEL**

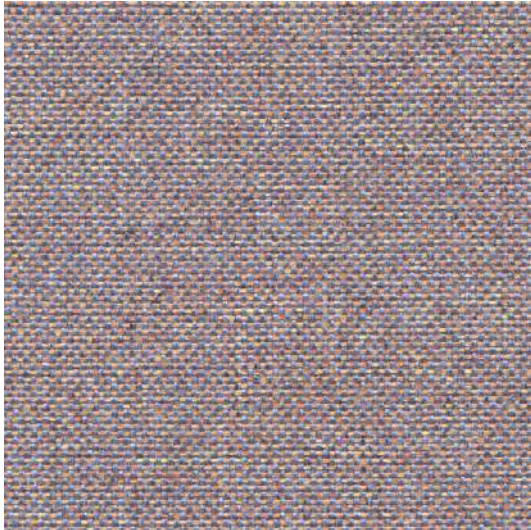

RC 658



RC 552



RC 656



RC 655



RC 455



RC 454



RC 353



RC 754



RC 752



RC 753



RC 152



RC 153

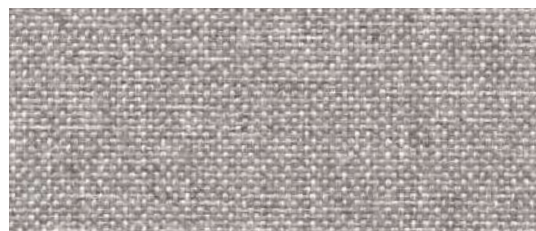

RC 851



RC 854



RC 255



RC 852

PL
Skład

100% Poliester Trevira CS®

Waga

250g/m² ± 5%

Szerokość rolki

140 cm

Odporność na ścieranie

70.000 cykli Martindale
(UNI EN ISO 12947-2:2017)

Pilling

5 (UNI EN ISO 12945-2:2002)

Odporność na światło

7 (EN ISO 105-B02:2014)

Odporność koloru na tarcie

Mokre: 4-5 (UNI EN ISO 105-X12:2016)
Suche: 4-5 (UNI EN ISO 105-X12:2016)

Certyfikaty trudnopalności

- EN 1021-1: 2006
- EN 1021-2: 2006
- BS 7176:2007 (Medium Hazard)
- BS 5852:2006 (CRIB 5)
- NFP 92-501-7 (M1)
- DIN 4102-1 (B1)
- IMO Res. A 652 (16) Part 8
- AM 18 (NF D 60013)
- UNI 9175 Class 1 IM

DE
Zusammensetzung

100% Poliester Trevira CS®

Gewicht

250g/m² ± 5%

Rollenbreite

140 cm

Scheuerfestigkeit

70.000 Zyklen Martindale
(UNI EN ISO 12947-2:2017)

Pilling

5 (UNI EN ISO 12945-2:2002)

Lichtechtheit

7 (EN ISO 105-B02:2014)

Reibechtheit

Nass: 4-5 (UNI EN ISO 105-X12:2016)
Trocken: 4-5 (UNI EN ISO 105-X12:2016)

Feuersicherung

- EN 1021-1: 2006
- EN 1021-2: 2006
- BS 7176:2007 (Medium Hazard)
- BS 5852:2006 (CRIB 5)
- NFP 92-501-7 (M1)
- DIN 4102-1 (B1)
- IMO Res. A 652 (16) Part 8
- AM 18 (NF D 60013)
- UNI 9175 Class 1 IM

EN
Composition

100% Poliester Trevira CS®

Weight

250g/m² ± 5%

Roll width

140 cm

Abrasion Resistance

70.000 Martindale cycles
(UNI EN ISO 12947-2:2017)

Pilling

5 (UNI EN ISO 12945-2:2002)

Light Fastness

7 (EN ISO 105-B02:2014)

Fastness to Rubbing

Wet: 4-5 (UNI EN ISO 105-X12:2016)
Dry: 4-5 (UNI EN ISO 105-X12:2016)

Flammability

- EN 1021-1: 2006
- EN 1021-2: 2006
- BS 7176:2007 (Medium Hazard)
- BS 5852:2006 (CRIB 5)
- NFP 92-501-7 (M1)
- DIN 4102-1 (B1)
- IMO Res. A 652 (16) Part 8
- AM 18 (NF D 60013)
- UNI 9175 Class 1 IM





KARO - **SN K**

SN K 084



HONEY - **SN H**

SN H 084



DOT - **SN D**

SN D 084

Dostępne kolory
Verfügbare Farben
Available colours



SN 084



SN 072



SN 011



SN 061

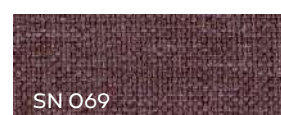

SN 069



SN 017

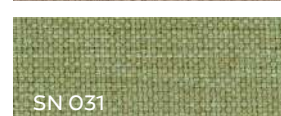

SN 031

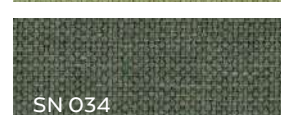

SN 034



SN 080

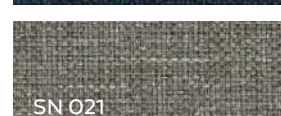

SN 021



SN 005

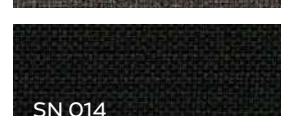

SN 014

PL**Powłoka**

100% (PES) - Poliester

Nośnik

100% (PP) - Polipropylen

Waga

375g/m² ± 5%

Szerokość rolki

140 cm

Odporność na ścieranie

70 000 cykli Martindale
(BS EN ISO 12947-2:1999)

Pilling

4-5 (DIN EN ISO 12945/2:2000)

Odporność na światło

4 (EN ISO 105-B02:2013)

Odporność koloru na tarcie

Mokre: 4 (UNI EN ISO 105-X12:2016)
Suche: 4-5 (UNI EN ISO 105-X12:2016)

Certyfikaty trudnopalności

-DIN EN 1021-1

DE**Oberfläche**

Oberfläche: 100% (PES) - Polyester

Träger

100% (PP) - Polypropylen

Gewicht

375g/m² ± 5%

Rollenbreite

140 cm

Scheuerfestigkeit

70 000 Zyklen Martindale
(BS EN ISO 12947-2:1999)

Pilling

4-5 (DIN EN ISO 12945/2:2000)

Lichtechtheit

4 (EN ISO 105-B02:2013)

Reibechtheit

Nass: 4 (UNI EN ISO 105-X12:2016)
Trocken: 4-5 (UNI EN ISO 105-X12:2016)

Feuersicherung

-DIN EN 1021-1

EN**Surface**

100% PES - Polyester

Backing

100% PP - Polypropylen

Weight

375g/m² ± 5%

Roll width

140 cm

Abrasion Resistance

70 000 Martindale cycles
(BS EN ISO 12947-2:1999)

Pilling

4-5 (DIN EN ISO 12945/2:2000)

Light Fastness

4 (EN ISO 105-B02:2013)

Fastness to Rubbing

Wet: 4 (UNI EN ISO 105-X12:2016)
Dry: 4-5 (UNI EN ISO 105-X12:2016)

Flammability

-DIN EN 1021-1





VL 211



VL 619

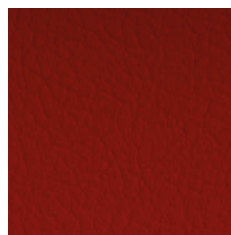

VL 275

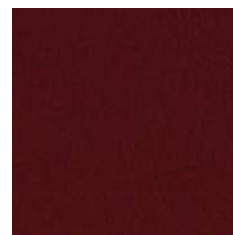

VL 262



VL 207

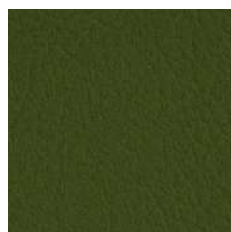

VL 501

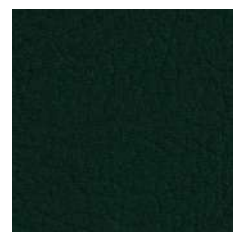

VL 569



VL 369

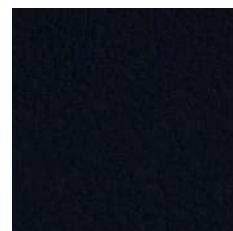

VL 368

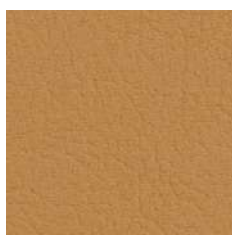

VL 217



VL 444



VL 020



VL 440



VL 445

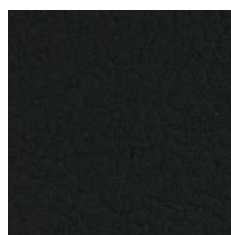

VL 403

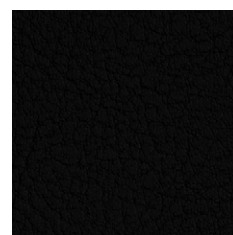

VL 935



odporna na ścieranie
exzellente Abriebfestigkeit
abrasion resistant



odporna na promienie UV
lichtechtheit
UV resistant



ochrona przed mikroorganizmami
antimikrobiell ausgerüstet
mildew resistant



wodoodporna
wasserabweisend
impermeability



odporna na produkty chemiczne
chemikalienbeständig
chemical resistant



odporność na krew i mocz
resistenz gegen Blut und Urin
resistance to blood and urine



trudnozapałna
flammhemmend ausgerüstet
flame retardant



odporna na niskie temperatury
kältenbruch resistent
low temperature resistant

PERMABLOK³
ADVANCED VINYL PROTECTION

PL Charakterystyka:

- bariera przed drobnoustrojami
- bariera przeciwbakteryjna
- bariera przeciwwgrzybiczna
- odporna na ścieranie
- odporna na zabrudzenia (krew, mocz)

DE Charakteristik:

- antimikrobielle Ausrüstung
- antibakterielle Ausrüstung
- antimykotische Ausrüstung
- hohe Abriebfestigkeit
- schmutzabweisend (Blut, Urin)

EN Characteristic:

- antimicrobial protection
- antibacterial protection
- antimycotic protection
- abrasion resistance
- resistance to dirt (Blood, Urine)

PERMABLOCK to sprawdzona powłoka chroniąca winyl, która tworzy mocną i skuteczną barierę przed największymi problemami występującymi w branży hotelarskiej i służbie zdrowia.

PERMABLOCK ist geprüfte Schutzschicht, die eine starke und effektive Barriere gegen die wichtigsten Probleme in der Hotelbranche und Krankenhauswesen ausmacht.

PERMABLOCK is proven vinyl protective coating, engineered to create a tough effective barrier against the biggest problems encountered in contract, healthcare and hospitality environments.

Należy unikać olejów, tłuszczów i substancji agresywnych (np. silne domowe środki czyszczące). Mogą one zniszczyć powierzchnię materiału. Zniszczenie materiału może doprowadzić do usunięcia plastyfikatorów i w rezultacie do stwardnienia materiału.

Man sollte Öle und starke Reinigungsmittel vermeiden. Sie können die Oberfläche des Stoffes beschädigen. Diese Beschädigung kann Entfernen von Weichmachern verursachen und zu Verhärtung des Stoffes führen.

Avoid contact with oils, fats or aggressive substances (e.g. strong household cleaners). These may damage the surface may lead to the extraction of plasticizers and consequently a rigidification of the material.

Barwniki i pigmenty mogą zabarwiać winyl. W szczególności materiały tekstylne mogą zawierać silne pigmenty (np. jeansy, kamizelki czy paski), których nie można całkowicie usunąć.

Farbstoffe und Pigmente können Vinyl verfärben, insbesondere Textilien, die starke Pigmente beinhalten (wie Jeanshosen, Westen, Gürtel), welche völlig nicht entfernt werden können.

Dyestuffs and colorant may discolor vinyl. Especially textiles can contain strong colorants (e.g. jeans, jackets or belts) which possibly cannot be removed completely.

Powłoka
100% Winył

Oberfläche
100% Vinyl

Surface
100% Vinyl

Nośnik
100% Poliester Hi-Loft 2™

Gewebe
100% Polyester Hi-Loft 2™

Basic material
100% Polyester Hi-Loft 2™

Waga
650 g/m²

Gewicht
650 g/m²

Weight
650 g/m²

Szerokość rolki
137 cm

Rollenbreite
137 cm

Roll width
137 cm

Odporność na ścieranie
300 000 cykli Martindale'a
(UNE-EN ISO 14465:2004)
(UNE-EN ISO 12947-2 1999)

Scheuerfestigkeit
300 000 Zyklen Martindale
(UNE-EN ISO 14465:2004)
(UNE-EN ISO 12947-2 1999)

Fastness to Rubbing
300 000 Martindale cycles
(UNE-EN ISO 14465:2004)
(UNE-EN ISO 12947-2 1999)

Odporność na światło
>7 (Xenon test DIN 54004)

Lichtechtheit
>7 (Xenon test DIN 54004)

Light Fastness
>7 (Xenon test DIN 54004)

Trudnozapałność
-UNE EN 1021-1:2015
-UNE EN 1021-2:2015
-DIN 4102 B2
-EN 71-2:2006 + A1:2007
-IMO Res. MSC.307(88) - (2010 FTP Code) Annex 1 Part 8

Feuersicherung
-UNE EN 1021-1:2015
-UNE EN 1021-2:2015
-DIN 4102 B2
-EN 71-2:2006 + A1:2007
-IMO Res. MSC.307(88) - (2010 FTP Code) Annex 1 Part 8

Flammability
-UNE EN 1021-1:2015
-UNE EN 1021-2:2015
-DIN 4102 B2
-EN 71-2:2006 + A1:2007
-IMO Res. MSC.307(88) - (2010 FTP Code) Annex 1 Part 8

Inne
-EN 71-3:2006 + A1:2007

Andere
-EN 71-3:2006 + A1:2007

Other
-EN 71-3:2006 + A1:2007

Przedstawiona kolorystyka nie stanowi oferty w rozumieniu prawa. Vorgestellte Farbgebung ist kein Angebot im Sinne der Rechtsvorschriften. The colours presented do not constitute an offer within the meaning of law.



A large, light gray, stylized number '3' graphic that serves as a background for the page. It is composed of thick, rounded strokes. The top bar is horizontal, the middle stroke curves downwards and to the left, and the bottom stroke curves upwards and to the left, meeting the middle stroke.

3 grupa cenowa
3rd price group
3. Preisgruppe

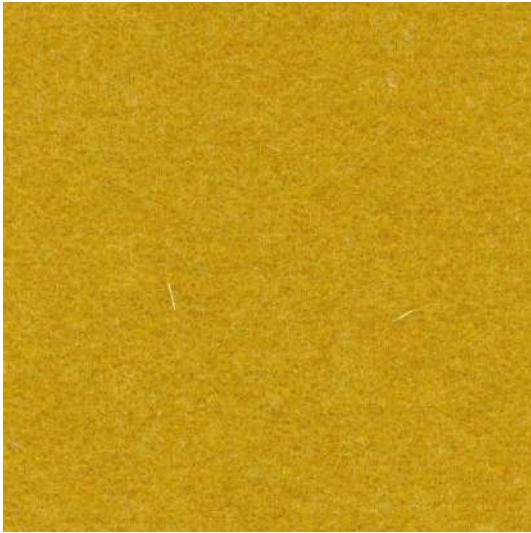

CUZ2W



CUZ39



CUZ18



CUZ21



CUZ90



CUZ63



CUZ1L



CUZ1K

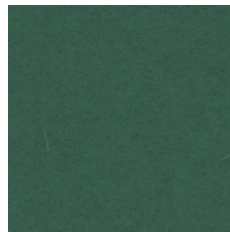

CUZ1N

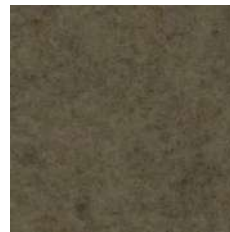

CUZ31



CUZ02



CUZ1R

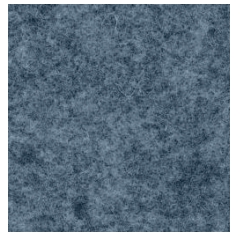

CUZ1W

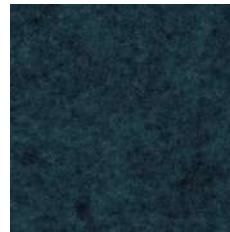

CUZ62



CUZ09



CUZ67



CUZ12



CUZ28



CUZ30



CUZ08

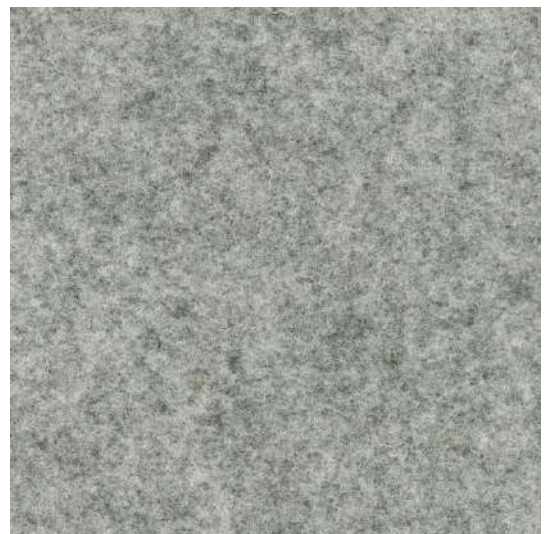

CUZ1E

PL

Skład
100% Wełna

Waga
460 g/m² ± 5%

Szerokość rolki
140 cm

Odporność na ścieranie
65 000 cykli Martindale'a
(BS EN ISO 12947-2:2016)

Pilling
>3 (UNI EN ISO 12945/2):2000

Odporność na światło
5 (BS EN ISO 105:BO2:2014-BS6)

Odporność koloru na tarcie
Mokre: 5 (BS EN ISO 105-X12:2016)
Suche: 4-5 (BS EN ISO 105-X12:2016)

Certyfikaty trudnopalności
-BS EN 1021 - 1:2014
-BS EN 1021 - 2:2014
-BS7176:2007 Low Hazard
-UN 9175:2010 1IM
-NFD60-013

Czyszczenie
-na sucho

DE

Zusammensetzung
100% Schurwolle

Gewicht
460 g/m² ± 5%

Rollenbreite
140 cm

Scheuerfestigkeit
65 000 Zyklen Martindale
(BS EN ISO 12947-2:2016)

Pilling
>3 (UNI EN ISO 12945/2):2000

Lichtechtheit
5 (BS EN ISO 105:BO2:2014-BS6)

Reibechtheit
Nass: 5 (BS EN ISO 105-X12:2016)
Trocken: 4-5 (BS EN ISO 105-X12:2016)

Feuersicherung
-BS EN 1021 - 1:2014
-BS EN 1021 - 2:2014
-BS7176:2007 Low Hazard
-UN 9175:2010 1IM
-NFD60-013

Reinigung
-Trockenreinigung

EN

Composition
100% Virgin Wool

Weight
460 g/m² ± 5%

Roll width
140 cm

Abrasion Resistance
65 000 Martindale cycles
(BS EN ISO 12947-2:2016)

Pilling
>3 (UNI EN ISO 12945/2):2000

Light Fastness
5 (BS EN ISO 105:BO2:2014-BS6)

Fastness to Rubbing
Wet: 5 (BS EN ISO 105-X12:2016)
Dry: 4-5 (BS EN ISO 105-X12:2016)

Flammability
-BS EN 1021 - 1:2014
-BS EN 1021 - 2:2014
-BS7176:2007 Low Hazard
-UN 9175:2010 1IM
-NFD60-013

Cleaning
-dry cleaning





CS 033



CS 430



CS 032



CS 421



CS 432



CS 201



CS 605



CS 602



CS 441



CS 601



CS 021



CS 125



CS 013

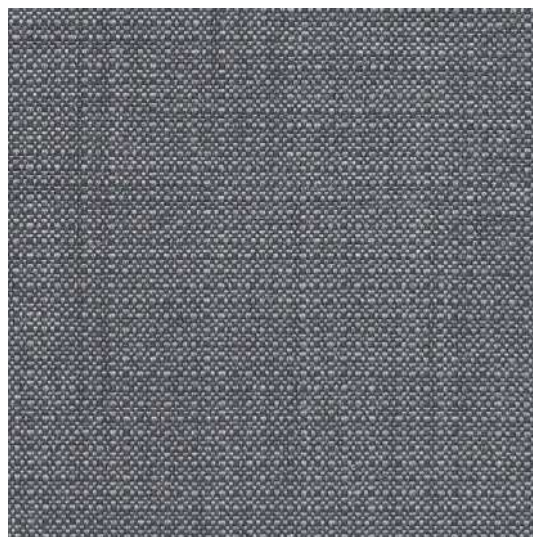

CS 022

PL**Skład**

93% Wełna, 7% Poliamid

Waga

328 g/m²

Szerokość rolki

140 cm

Odporność na ścieranie

200.000 cykli Martindale
(BS EN ISO 12947-2:1998 AC 2008)

Pilling

4-5 (BS EN ISO 12945-2:2000)

Odporność na światło

6-7 (ISO 105-B02)

Odporność koloru na tarcie

Mokre: 5 (UNI EN ISO 105-X12):2016
Suche: 5 (UNI EN ISO 105-X12):2016

Certyfikaty trudnopalności

-BS EN 1021 1&2:2014
-BS:5852 Part 1:1979
-UNI 9175: 2010 Class 1 IM

Inne

-IMO Res. A.652 (16)
-IMO Res.MSC 61 (67) Annex 1, Part 8
-IMO Res.MSC 307 (88) Annex 1, Part 8

DE**Zusammensetzung**

93% Schurwolle, 7% Poliamid

Gewicht

328 g/m²

Rollenbreite

140 cm

Scheuerfestigkeit

200.000 Zyklen Martindale
(BS EN ISO 12947-2:1998 AC 2008)

Pilling

4-5 (BS EN ISO 12945-2:2000)

Lichtechtheit

6-7 (ISO 105-B02)

Reibechtheit

Nass: 4 (UNI EN ISO 105-X12):2016
Trocken: 5 (UNI EN ISO 105-X12):2016

Feuersicherung

-BS EN 1021 1&2:2014
-BS:5852 Part 1:1979
-UNI 9175: 2010 Class 1 IM

Andere

-IMO Res. A.652 (16)
-IMO Res.MSC 61 (67) Annex 1, Part 8
-IMO Res.MSC 307 (88) Annex 1, Part 8

EN**Composition**

93% Wool, 7% Polyamid

Weight

328 g/m²

Roll width

140 cm

Abrasion Resistance

200.000 Martindale cycles
(BS EN ISO 12947-2:1998 AC 2008)

Pilling

4-5 (BS EN ISO 12945-2:2000)

Light Fastness

6-7 (ISO 105-B02)

Fastness to Rubbing

Wet: 4 (UNI EN ISO 105-X12):2016
Dry: 5 (UNI EN ISO 105-X12):2016

Flammability

-BS EN 1021 1&2:2014
-BS:5852 Part 1:1979
-UNI 9175: 2010 Class 1 IM

Other

-IMO Res. A.652 (16)
-IMO Res.MSC 61 (67) Annex 1, Part 8
-IMO Res.MSC 307 (88) Annex 1, Part 8



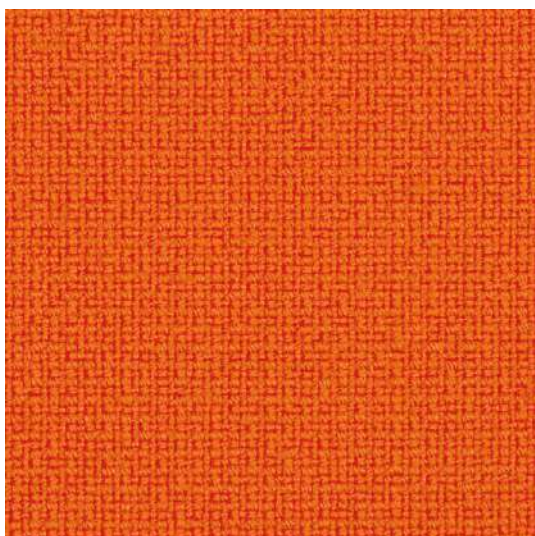

F 3016



F 4119



F 2067



F 8035



F 6118



F 6075

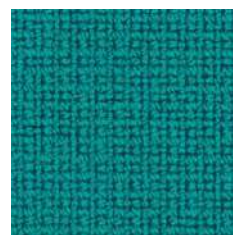

F 7016

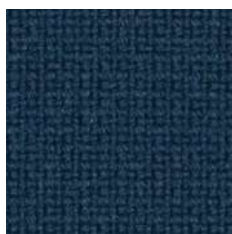

F 6071



F 0017



F 0019

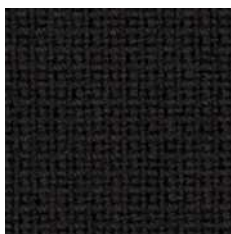

F 0099

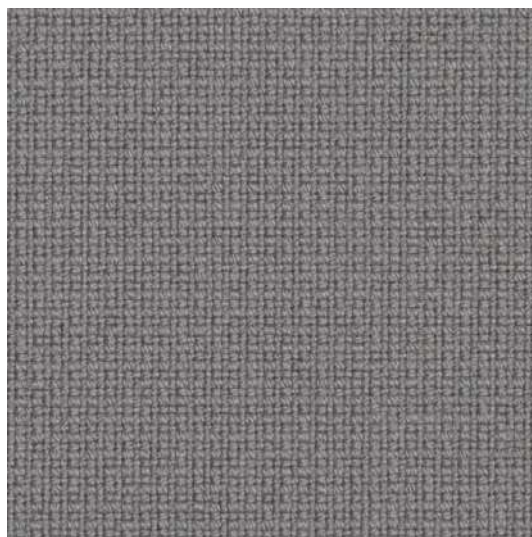

F 0078

PL**Skład**

95% Wełna, 5% Poliamid

Waga

450 g/m²

Szerokość rolki

140 cm

Odporność na ścieranie

210 000 cykli Martindale
(BS EN ISO 12947-2: 1998)

Pilling

3-4 (BS EN ISO 12945-2: 2000)

Odporność na światło

5-7 (BS EN ISO 105-B02: 2014)-BS7

Odporność koloru na tarcie

Mokre: 4-5 (UNI EN ISO 105-X12: 2002)
Suche: 4-5 (UNI EN ISO 105-X12: 2002)

Certyfikaty trudnopalności

-BS EN 1021-1: 2014
-BS EN 1021-2: 2014
-BS 5852: 2006 Clause 11 Crib 5
-UNI 9175: 2010 Class 1 IM
-AM 18 NF D 60-013

Inne

-IMO Res. A.652 (16)
-IMO Res.MSC 61 (67) Annex 1, Part 8
-IMO Res.MSC 307 (88) Annex 1, Part 8

Czyszczenie

-na sucho

DE**Zusammensetzung**

95% Schurwolle, 5% Poliamid

Gewicht

450 g/m²

Rollenbreite

140 cm

Scheuerfestigkeit

210 000 Zyklen Martindale
(BS EN ISO 12947-2: 1998)

Pilling

3-4 (BS EN ISO 12945-2: 2000)

Lichtechtheit

5-7 (BS EN ISO 105-B02: 2014)-BS7

Reibechtheit

Nass: 4-5 (UNI EN ISO 105-X12: 2002)
Trocken: 4-5 (UNI EN ISO 105-X12: 2002)

Feuersicherung

-BS EN 1021-1: 2014
-BS EN 1021-2: 2014
-BS 5852: 2006 Clause 11 Crib 5
-UNI 9175: 2010 Class 1 IM
-AM 18 NF D 60-013

Andere

-IMO Res. A.652 (16)
-IMO Res.MSC 61 (67) Annex 1, Part 8
-IMO Res.MSC 307 (88) Annex 1, Part 8

Reinigung

-Trockenreinigung

EN**Composition**

95% Wool, 5% Polyamide

Weight

450 g/m²

Roll width

140 cm

Abrasion Resistance

210 000 Martindale cycles
(BS EN ISO 12947-2: 1998)

Pilling

3-4 (BS EN ISO 12945-2: 2000)

Light Fastness

5-7 (BS EN ISO 105-B02: 2014)-BS7

Fastness to Rubbing

Wet: 4-5 (UNI EN ISO 105-X12: 2002)
Dry: 4-5 (UNI EN ISO 105-X12: 2002)

Flammability

-BS EN 1021-1: 2014
-BS EN 1021-2: 2014
-BS 5852: 2006 Clause 11 Crib 5
-UNI 9175: 2010 Class 1 IM
-AM 18 NF D 60-013

Other

-IMO Res. A.652 (16)
-IMO Res.MSC 61 (67) Annex 1, Part 8
-IMO Res.MSC 307 (88) Annex 1, Part 8

Cleaning

-dry cleaning



easy to clean

SILVERTEX 

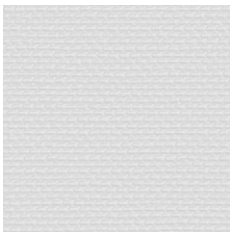

SV 280

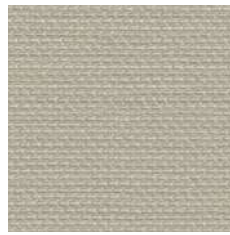

SV 001

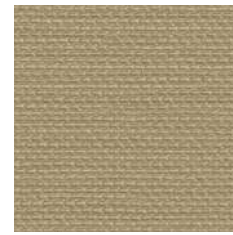

SV 009



SV 424



SV 065



SV 662

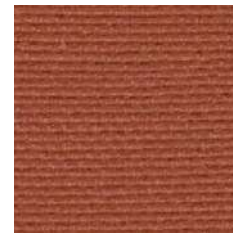

SV 661



SV 211



SV 010



SV 508



SV 064



SV 214



SV 563



SV 031



SV 067

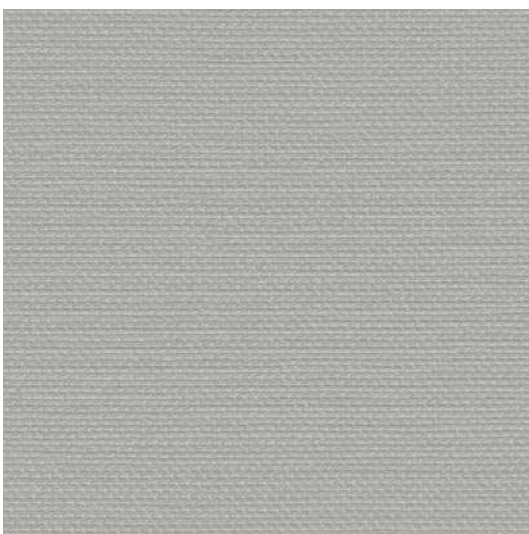

SV 401



SV 213



SV 307



SV 402

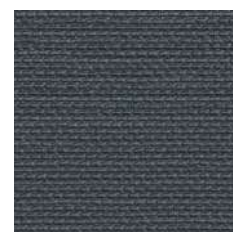

SV 902



SV 901



odporna na ścieranie
exzellente Abriebfestigkeit
abrasion resistant



odporna na promienie UV
lichtechtheit
UV resistant

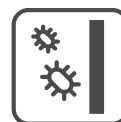

ochrona przed mikroorganizmami
antimikrobiell ausgerüstet
mildew resistant



wodoodporna
wasserweisend
impermeability



odporna na produkty chemiczne
chemikalienbeständig
chemical resistant



odporność na krew i uryne
resistenz gegen Blut und Urin
resistance to blood and urine



trudnozapałna
flammhemmend ausgerüstet
flame retardant



odporna na niskie temperatury
kältenbruch resistent
low temperature resistant



PL Charakterystyka:

- bariera przed drobnoustrojami
- bariera przeciwbakteryjna
- bariera przeciwwgrzybiczna
- odporna na ścieranie
- odporna na zabrudzenia (krew, uryna)

PERMABLOCK to sprawdzona powłoka chroniąca winyl, która tworzy mocną i skuteczną barierę przed największymi problemami występującymi w branży hotelarskiej i służbie zdrowia.

Należy unikać olejów, tłuszczów i substancji agresywnych (np. silne domowe środki czyszczące). Mogą one zniszczyć powierzchnię materiału. Zniszczenie materiału może doprowadzić do usunięcia plastyfikatorów i w rezultacie do stwardnienia materiału.

Barwniki i pigmenty mogą odbarwiać winyl. W szczególności materiały tekstylne mogą zawierać silne pigmenty (np. jeansy, kamizelki czy paski), których nie można całkowicie usunąć.

Powłoka
100% Winył

Nośnik
100% Poliester Hi-Loft 2™

Waga
685 g/m²

Szerokość rolki
137 cm

Odporność na ścieranie
300 000 cykli Martindale
(UNE EN 14465:2004+A1:2007)

Odporność na światło
Xenontest (DIN 54004)-7

Trudnozapałność
-EN 1021 Part 1 & 2: 2015
-EN 71-2:2006+A1:2007
-DIN 4102 B2
-NF P 92-503/M2
-UNI 9175 (1987) / UNI 9175/FA1 (1994) Classe 1.IM
-(MED) Council Directive 96/98 EC on marine equipment
-IMO A 652 (16) Annex I, 8,2 and 8,3

Inne
-EN 71-3:2006+A1:2007

DE Charakteristik:

- antimikrobielle Ausrüstung
- antibakterielle Ausrüstung
- antimykotische Ausrüstung
- hohe Abriebfestigkeit
- schmutzabweisend (Blut, Urin)

PERMABLOCK ist geprüfte Schutzschicht, die eine starke und effektive Barriere gegen die wichtigsten Probleme in der Hotelbranche und Krankenhauswesen ausmacht.

Man sollte Öle und starke Reinigungsmittel vermeiden. Sie können die Oberfläche des Stoffes beschädigen. Diese Beschädigung kann Entfernen von Weichmachern verursachen und zu Verhärtung des Stoffes führen.

Farbstoffe und Pigmente können Vinyl verfärben, insbesondere Textilien, die starke Pigmente beinhalten (wie Jeanshosen, Westen, Gürtel), welche völlig nicht entfernt werden können.

Oberfläche
100% Vinyl

Vinyl Träger
100% Polyester Hi-Loft 2™

Gewicht
685 g/m²

Rollenbreite
137 cm

Scheuerfestigkeit
300 000 Zyklen Martindale
(UNE EN 14465:2004+A1:2007)

Xenontest (Lichtechtheit)
Xenontest (DIN 54004)-7

Feuersicherung
-EN 1021 Part 1 & 2: 2015
-EN 71-2:2006+A1:2007
-DIN 4102 B2
-NF P 92-503/M2
-UNI 9175 (1987) / UNI 9175/FA1 (1994) Classe 1.IM
-(MED) Council Directive 96/98 EC on marine equipment
-IMO A 652 (16) Annex I, 8,2 and 8,3

Andere
-EN 71-3:2006+A1:2007

EN Characteristic:

- antimicrobial protection
- antibacterial protection
- antimycotic protection
- abrasion resistance
- resistance to dirt (Blood, Urine)

PERMABLOCK is proven vinyl protective coating, engineered to create a tough effective barrier against the biggest problems encountered in contract, healthcare and hospitality environments.

Avoid contact with oils, fats or aggressive substances (e.g. strong household cleaners). These may damage the surface may lead to the extraction of plasticizers and consequently a rigidification of the material.

Dyestuffs and colorant may discolor vinyl. Especially textiles can contain strong colorants (e.g. jeans, jackets or belts) which possibly cannot be removed completely.

Surface
100% Vinyl

Vinyl Backing
100% Polyester Hi-Loft 2™

Weight
685 g/m²

Roll width
137 cm

Fastness to Rubbing
300 000 Martindale cycles
(UNE EN 14465:2004+A1:2007)

Xenontest (Light Fastness)
Xenontest (DIN 54004)-7

Flammability
-EN 1021 Part 1 & 2: 2015
-EN 71-2:2006+A1:2007
-DIN 4102 B2
-NF P 92-503/M2
-UNI 9175 (1987) / UNI 9175/FA1 (1994) Classe 1.IM
-(MED) Council Directive 96/98 EC on marine equipment
-IMO A 652 (16) Annex I, 8,2 and 8,3

Other
-EN 71-3:2006+A1:2007

Przedstawiona kolorystyka nie stanowi oferty w rozumieniu prawa. Vorgestellte Farbgebung ist kein Angebot im Sinne der Rechtsvorschriften. The colours presented do not constitute an offer within the meaning of law.



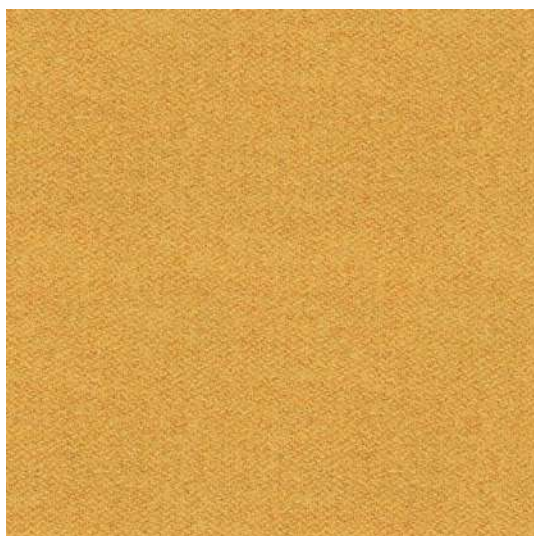

LDS 44



LDS 80



LDS 86

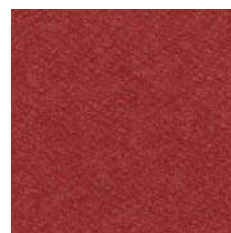

LDS 85

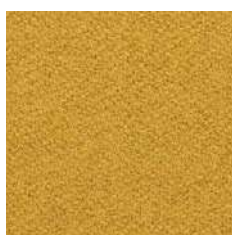

LDS 28



LDS 82



LDS 81



LDS 46



LDS 47



LDS 55



LDS 56



LDS 57



LDS 59



LDS 63

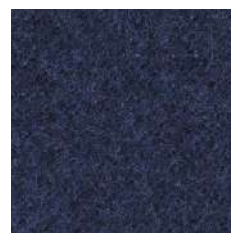

LDS 62



LDS 08



LDS 21



LDS 16



LDS 35



LDS 17

PL**Skład**

95% Wełna, 5% Poliamid

Waga

400g/m² ± 5%

Szerokość rolki

140 cm

Odporność na ścieranie

100.000 cykli Martindale
(BS EN ISO 12947-2: 2016)

Pilling

4 (BS EN ISO 12945-2: 2000)

Odporność na światło

5 (BS EN ISO 105-B02: 2014-BS6)

Odporność koloru na tarcie

Mokre: 4 (UNI EN ISO 105-X12)

Suche: 4 (UNI EN ISO 105-X12)

Certyfikaty trudnopalności

-BS EN 1021-1: 2014
-BS EN 1021-2: 2014
-BS 7176 Low Hazard
-UNI 9175: 2010 Class 1 IM
-ÖNORM B 3825 & A 3800-1

DE**Zusammensetzung**

95% Schurwolle, 5% Polyamid

Gewicht

400g/m² ± 5%

Rollenbreite

140 cm

Scheuerfestigkeit

100.000 Zyklen Martindale
(BS EN ISO 12947-2: 2016)

Pilling

4 (BS EN ISO 12945-2: 2000)

Lichtechtheit

5 (BS EN ISO 105-B02: 2014-BS6)

Reibechtheit

Nass: 4 (UNI EN ISO 105-X12)

Trocken: 4 (UNI EN ISO 105-X12)

Feuersicherung

-BS EN 1021-1: 2014
-BS EN 1021-2:2 014
-BS 7176 Low Hazard
-UNI 9175: 2010 Class 1 IM
-ÖNORM B 3825 & A 3800-1

EN**Composition**

95% Virgin Wool, 5% Polyamide

Weight

400g/m² ± 5%

Roll width

140 cm

Abrasion Resistance

100.000 Martindale cycles
(BS EN ISO 12947-2: 2016)

Pilling

4 (BS EN ISO 12945-2: 2000)

Light Fastness

5 (BS EN ISO 105-B02: 2014-BS6)

Fastness to Rubbing

Wet: 4 (UNI EN ISO 105-X12)

Dry: 4 (UNI EN ISO 105-X12)

Flammability

-BS EN 1021-1: 2014
-BS EN 1021-2: 2014
-BS 7176 Low Hazard
-UNI 9175: 2010 Class 1 IM
-ÖNORM B 3825 & A 3800-1





4 grupa cenowa
4th price group
4. Preisgruppe



RX 612



RX 643



RX 632



RX 933



RX 912



RX 733



RX 762



RX 123



RX 163



RX 173



RX 393

PL**Skład**

90% Wełna, 10% Nylon

Waga

~300 g/m²

Szerokość rolki

138 cm

Odporność na ścieranie

100 000 cykli Martindale
(EN ISO 12947-2:2016)

Pilling

4-5 (EN ISO 12945-2:2000)

Odporność na światło

5-7 (EN ISO 105-B02:2014)

Odporność koloru na tarcie

Mokre: 4-5 (EN ISO 105-X12:2001)
Suche: 4-5 (EN ISO 105-X12:2001)

Certyfikaty trudnopalności

-BS EN 1021-1/2:2014
-BS 5852:Part 1:1979
-Önorm B1/Q1
-NF D 60 013
-UNI 9175 1IM
-IMO FTP Code 2010: Part 8

Czyszczenie

Odkurzanie i czyszczenie chemiczne

DE**Zusammensetzung**

90% Schurwolle, 10% Nylon

Gewicht

~300 g/m²

Rollenbreite

138 cm

Scheuerfestigkeit

100 000 Zyklen Martindale
(EN ISO 12947-2:2016)

Pilling

4-5 (EN ISO 12945-2:2000)

Lichtechtheit

5-7 (EN ISO 105-B02:2014)

Reibechtheit

Nass: 4-5 (EN ISO 105-X12:2001)
Trocken: 4-5 (EN ISO 105-X12:2001)

Feuersicherung

-BS EN 1021-1/2:2014
-BS 5852:Part 1:1979
-Önorm B1/Q1
-NF D 60 013
-UNI 9175 1IM
-IMO FTP Code 2010: Part 8

Reinigung

Staubsaugen und Reinigung

EN**Composition**

90% Virgin Wool, 10% Nylon

Weight

~300 g/m²

Roll width

138 cm

Abrasion Resistance

100 000 Martindale cycles
(EN ISO 12947-2:2016)

Pilling

4-5 (EN ISO 12945-2:2000)

Light Fastness

5-7 (EN ISO 105-B02:2014)

Fastness to Rubbing

Wet: 4-5 (EN ISO 105-X12:2001)
Dry: 4-5 (EN ISO 105-X12:2001)

Flammability

-BS EN 1021-1/2:2014
-BS 5852:Part 1:1979
-Önorm B1/Q1
-NF D 60 013
-UNI 9175 1IM
-IMO FTP Code 2010: Part 8

Cleaning

Vacuuming and dry cleaning





S-336

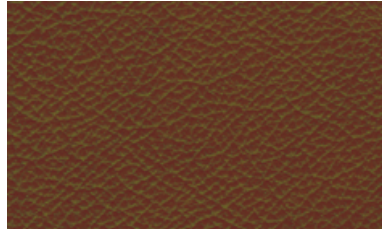

B-478



S-154



C-181

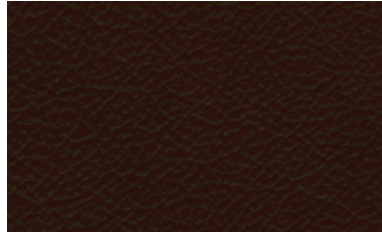

B-5458

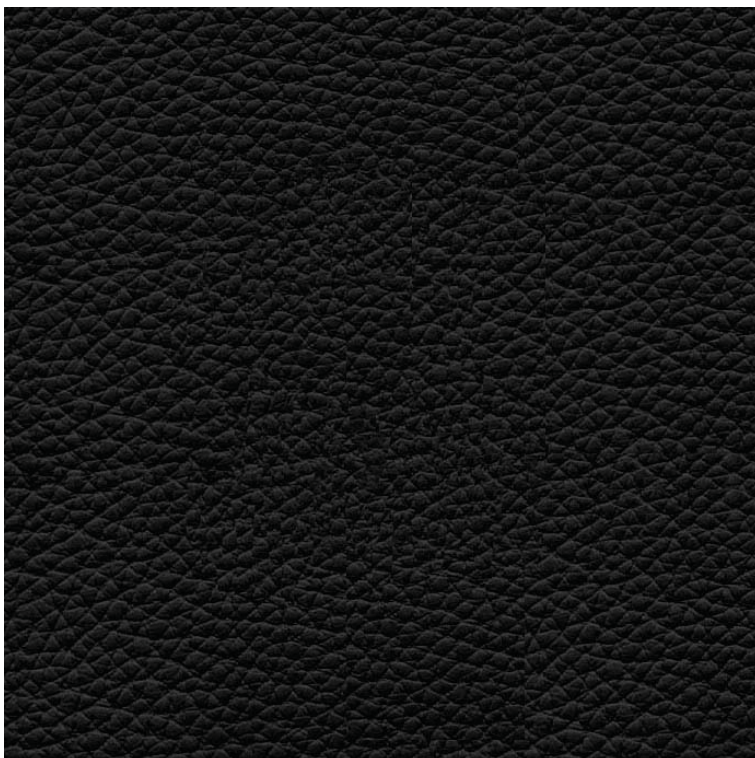

S-black



S-white



S-120



S-antracyt

PL**Wielkość błamu**~4.2m²**Grubość**

>0.9 mm - 1.1 mm

Test tarcia na mokro

>250 (BS EN ISO 11640: 1998)

Test tarcia na sucho

>500 (BS EN ISO 11640:1998)

Zginanie

50.000 cykli (BS EN ISO 5402:2002)

-Nie stosowano PCP i CFC podczas procesu garbowania

-Mogą występować niewielkie zmiany w odcieniu i strukturze

Certyfikaty trudnopalności

-EN 1021-1:2006

-EN 1021-2:2006

DE**Groesse Ca.**~4.2m²**Dicke**

>0.9 mm - 1.1 mm

Rebungstest nass

>250 (BS EN ISO 11640: 1998)

Rebungstest trocken

>500 (BS EN ISO 11640:1998)

Flexometry

50.000 Zyklen (BS EN ISO 5402:2002)

-PCP und CFC bei Gerben wurden nicht verwendet

-Es koennen kleine Unterschiede in der Faerbung hervortreten

Feuersicherung

-EN 1021-1:2006

-EN 1021-2:2006

EN**Size Ca.**~4.2m²**Thickness**

>0.9 mm - 1.1 mm

Wet rub test

>250 (BS EN ISO 11640: 1998)

Dry rub test

>500 (BS EN ISO 11640:1998)

Flexometry

50.000 cycles (BS EN ISO 5402:2002)

-No PCP or CFC used during tanning process

-Natural colour variations may occur

Flammability

-EN 1021-1:2006

-EN 1021-2:2006

ścieg ozdobny/ decorative stich
haft / embroidery / Stickerei
filc/felt/filz
membrana / membrane / Membrany
melamina / melamine / Melamin
metal / metal / Metall
drewno / wood / Holz
plastik / Kunststoff / plastic

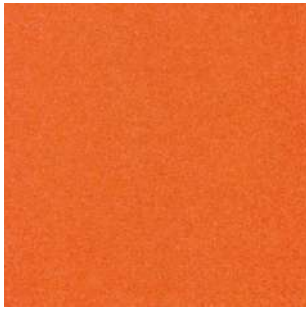

3004

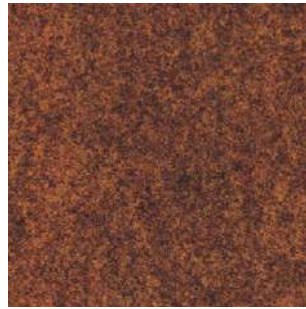

3006



4002



6011



6013



2021



7025



7040

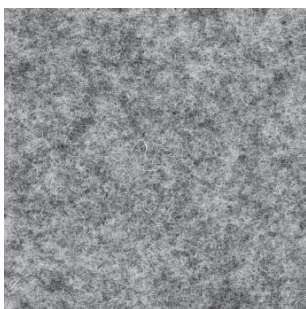

5318

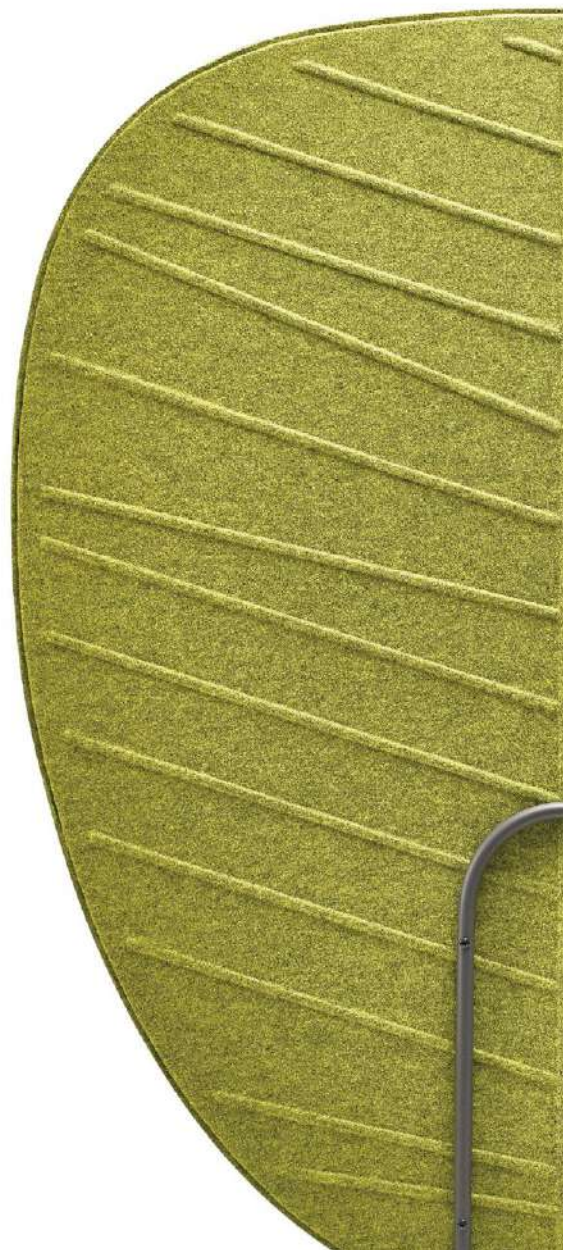

PL**Skład**

C 5318 – 100% Poliester
Pozostałe kolory – 100% Polipropylen

Waga

300g/m² ± 10%
(ISO-9073-1)

Grubość

3,0 mm ± 10%
(ISO-9073-2)

Szerokość rolki

C 5318 – 150 cm +- 3
Pozostałe kolory – 155 cm +- 3

Trudnopalność

-PN-EN 1021-1:2014
-PN-EN 1021-2:2014

DE**Zusammensetzung**

C 5318 – 100% Polyester
Andere Farben – 100% Polypropylen

Gewicht

300g/m² ± 10%
(ISO-9073-1)

Dicke

3,0 mm ± 10%
(ISO-9073-2)

Rollenbreite

C 5318 – 150 cm +- 3
Andere Farben – 155 cm +- 3

Feuersicherung

-PN-EN 1021-1:2014
-PN-EN 1021-2:2014

EN**Composition**

C 5318 – 100% Polyester
Other colours – 100% Polypropylene

Weight

300g/m² ± 10%
(ISO-9073-1)

Thickness

3,0 mm ± 10%
(ISO-9073-2)

Roll width

C 5318 – 150 cm +- 3
Other colours – 155 cm +- 3

Flammability

-PN-EN 1021-1:2014
-PN-EN 1021-2:2014

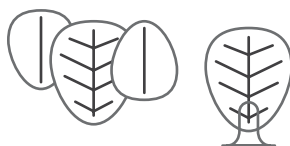

Karta przedstawia przykładowe wielkości haftów.
Wielkość i wzór zależą od indywidualnych potrzeb klientów.

Diese Karte zeigt eine mögliche Stickerei-Größe. Die Größe und das
Muster sind abhängig von den individuellen Bedürfnissen des Kunden.

The sheet contains examples of embroidery sizes. Logo size and project
depend on individual customers' needs.



50 cm²

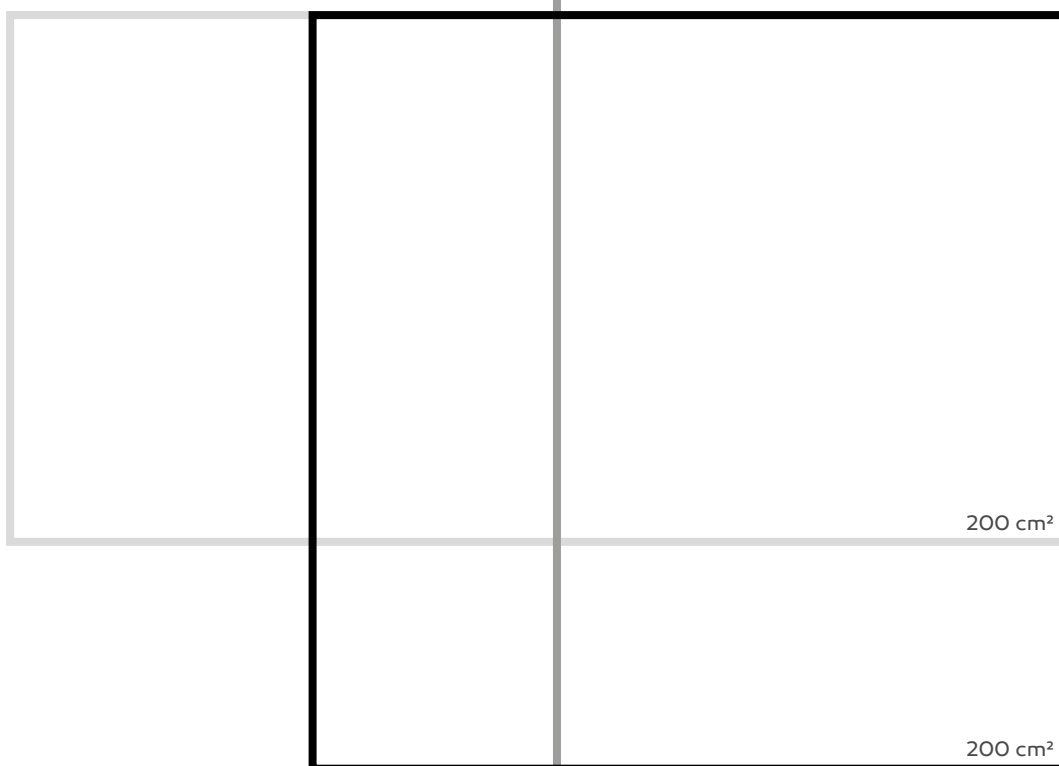

200 cm²

200 cm²

200 cm²

YOUR **chair**
YOUR **LOGO**

PL Wymagania, jakie należy spełnić przy zamówieniu z haftem:

- w zamówieniu należy wskazać produkty w których ma zostać wykonany haft
- przesłany wzór logo należy opisać numerem zamówienia, którego dotyczy
- wymagane formaty to: **.pdf / .eps / .ai / .jpg / .bmp**
- grafika musi dokładnie przedstawiać logo, którego haft ma zostać umieszczony na produktach (nie przerabiamy wzorów logo)
- wraz z przesłanym wzorem należy określić wysokość i szerokość haftu (maksymalnie 10cm x 20cm)
- należy przesłać zdjęcie lub rysunek z dokładnie zaznaczonym umiejscowieniem haftu na produkcie według poniższego wzoru

Ze względu na rozbieżność odczytu komputerowego ostateczne kolory logo mogą w niewielkim stopniu różnić się od przesłanego wzoru. Jeśli klient wymaga całkowitej zgodności z przesłanym wzorem, konieczne jest przesłanie oznaczeń zgodnych z wzornikiem Pantone. W takim wypadku próbka z haftem zostaje wysłana do akceptacji. Od momentu uzyskania akceptacji haftu zostaje rozpoczęta produkcja.

DE Forderungen die beim Bestellen von Produkten mit einer Logo-Stickerei zu erfüllen sind:

- geben Sie in ihrer Bestellung die Namen der Produkte an, die mit Logo bestickt sein sollten
- geben Sie die Nummer der Bestellung an, auf die sich das Logomuster bezieht
- die zulässigen Formate der Dateien mit dem Logo sind: **.pdf / .eps / .ai / .jpg / .bmp**
- das Logomuster muss das Logo genau darstellen (wir überarbeiten Logomuster nicht)
- geben Sie die gewünschte Höhe und Breite der Stickerei an (maximale Abmessungen: 10cm x 20cm)
- Schicken Sie ein Foto oder eine Zeichnung mit genauer Lage der Stickerei auf dem Produkt nach folgendem Beispiel

Die endgültigen Farben des Logo können sich von dem zugeschickten Muster durch eine Computerverarbeitung geringfügig unterscheiden. Wünschen Sie sich eine völlige Übereinstimmung mit dem zugeschickten Muster wünschen, müssen Sie sich der Pantone Schablonen bedienen. In diesem Fall werden wir Ihnen ein Muster mit der Stickerei zuschicken und mit der Produktion erst nach Ihrer Freigabe beginnen.

EN Requirements to be met when ordering embroidered products:

- give the names of the products in which embroidery is to be made in your order
- give the order number to which the sent logo file applies
- required formats of the file with the logo: **.pdf / .eps / .ai / .jpg / .bmp**
- the logo file must exactly present the logo the embroidery of which is to be placed on the products (we do not modify logo patterns)
- state the exact height and width of the embroidery with the sent pattern (maximum dimensions: 10cm x 20cm)
- send a photograph or a drawing showing the exact location of the embroidery on the product according to the template below

Because of the deviations in the computer readout, the final colors of the logo may slightly differ from the sent logo. If you require total conformity with the sent pattern, you must use Pantone color templates. In such case, a sample with embroidery will be sent to your approval, and we will start the production after its acceptance.

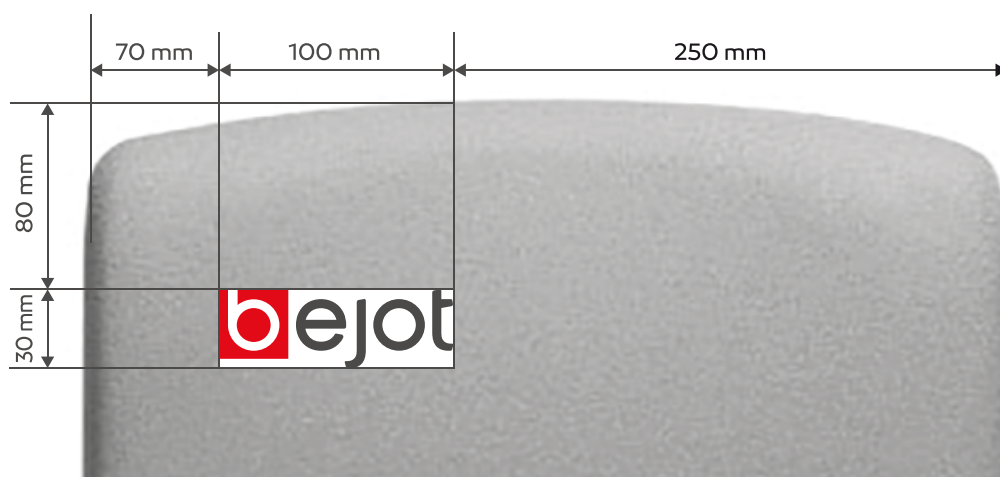

SIATKA BATYLINE/ BATYLINE MESH

Serge Ferrari

Wzornik siatek do foteli Eleven i Kyos Mesh
Batyline meshmuster für Eleven und Kyos Mesh
Batyline mesh sampler for Eleven and Kyos Mesh

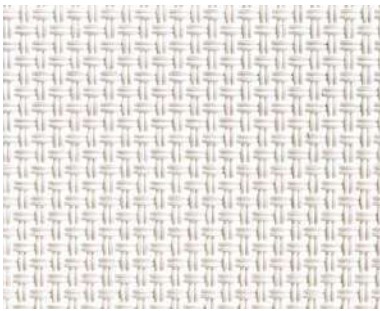

M 5001

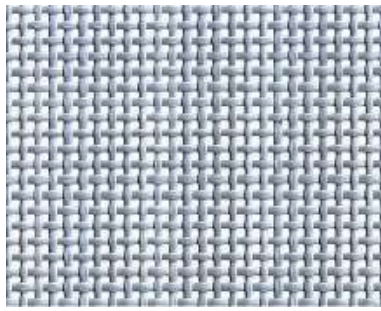

M 5003

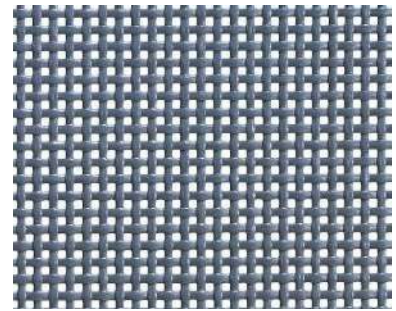

M 5004

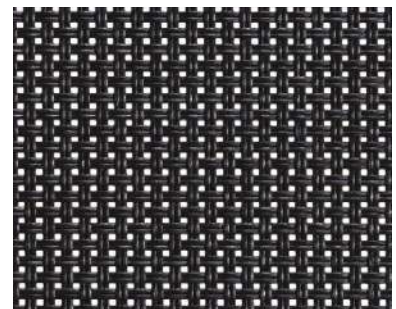

M 5005

SIATKA O/ MESH O

Wzornik siatki MESH O dla foteli Ovidio
MESH O muster für Ovidio
MESH O sampler for Ovidio

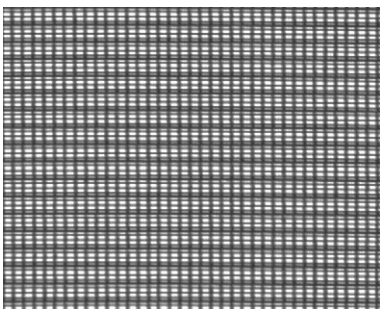

MOBL

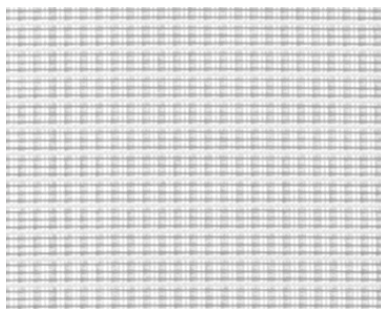

MOLG

SIATKA BATYLINE/ BATYLINE MESH Serge Ferrari**PL****Skład**
Poliester/PVC**Szerokość**
180 cm**Waga**
500 g/m²**Odporność na ścieranie**
150 000 cykli Martindale
(UNI EN ISO 12947-2:1999)**Odporność na światło**
≥7 (EN ISO 105-B02 Xenontest)**KORZYŚCI**

- Odporność na ścieranie, maksymalna wytrzymałość.
- Utrzymanie regularnych napięć: brak zjawiska workowatości.
- Pozostaje chłodna latem, bardzo szybko schnie.

DE**Zusammensetzung**
Polyester/PVC**Breite**
180 cm**Gewicht**
500 g/m²**Scheuerfestigkeit**
150 000 Zyklen Martindale
(UNI EN ISO 12947-2:1999)**Lichtechtheit**
≥7 (EN ISO 105-B02 Xenontest)**VORTEILE**

- Scheuerfest, maximale Festigkeit
- Haltung regulärer Spannungen: keine Sackförmigkeit
- Es bleibt im Sommer angenehm kühl, trocknet sehr schnell

EN**Composition**
Polyester/PVC**Width**
180 cm**Weight**
500 g/m²**Abrasion Resistance**
150 000 Martindale cycles
(UNI EN ISO 12947-2:1999)**Light Fastness**
≥7 (EN ISO 105-B02 Xenontest)**BENEFITS**

- Tear resistant, maximum strenght
- Tension regularly maintained: no bagging phenomenon
- Stays cool in summer, dries very quickly

SIATKA O/ MESH O**PL****Skład**
Polyelastomer 56% + Poliester 44%**Waga**
428 g/m²**Odporność na ścieranie**
>50 000 cykli Martindale
(BS EN ISO 12947-2:1999)**Pilling**
4-5 (BS EN ISO 12945-2:2000)**Odporność na światło**
>4 (EN ISO 105-B02:2014)**DE****Zusammensetzung**
Polyelastomer 56% + Polyester 44%**Gewicht**
428 g/m²**Scheuerfestigkeit**
>50 000 Zyklen Martindale
(BS EN ISO 12947-2:1999)**Pilling**
4-5 (BS EN ISO 12945-2:2000)**Lichtechtheit**
>4 (EN ISO 105-B02:2014)**EN****Composition**
Polyelastomer 56% + Polyester 44%**Weight**
428 g/m²**Abrasion Resistance**
>50 000 Martindale cycles
(BS EN ISO 12947-2:1999)**Pilling**
4-5 (BS EN ISO 12945-2:2000)**Light Fastness**
>4 (EN ISO 105-B02:2014)

MEMBRANA/ MEMBRANE

Wzornik membran dla fotel String
Membranemuster für String
Membrane sampler for String



MB01



MB06

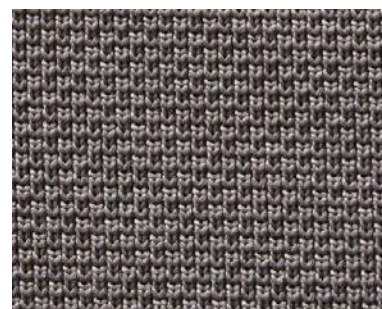

MB07

Wersja String 103 - z wysokim oparciem - pozostaje dostępna tylko w kolorze czarnym MB 01

String 103 - hohe Version - nur mit schwarze Membrane erreichbar MB 01

Model String 103 - with high backrest - will remain in offer only with black colour membrane MB 01

SIATKA MESH M/ MESH M

Wzornik siatki MESH M dla foteli Kyos Mesh, Fendo Mesh, Momo, Milla
MESH M muster für Kyos Mesh, Fendo Mesh, Momo, Milla
MESH M sampler for Kyos Mesh, Fendo Mesh, Momo, Milla



M08



M09

MEMBRANA/ MEMBRANE

PL

Skład
100% nylon

Waga
570 g/m²

Odporność na ścieranie
100 000 cykli Martindale
(UNI EN ISO 12947/2):1999

Certyfikaty trudnopalności
-BS EN 1021 - 1:2006
-BS EN 1021 - 2:2006

DE

Zusammensetzung
100% nylon

Gewicht
570 g/m²

Scheuerfestigkeit
100 000 Zyklen Martindale
(UNI EN ISO 12947/2):1999

Feuersicherung
-BS EN 1021 - 1:2006
-BS EN 1021 - 2:2006

EN

Composition
100% nylon

Weight
570 g/m²

Abrasion Resistance
100 000 Martindale cycles
(UNI EN ISO 12947/2):1999

Flammability
-BS EN 1021 - 1:2006
-BS EN 1021 - 2:2006

SIATKA M/ MESH M

PL

Skład
66% poliester, 34% poliamid

Waga
210 g/m²

Odporność na ścieranie
90 000 ± 5% cykli Martindale
-PN EN 14465:2005 + A1:2007
-PN EN 12947:2017-02

Odporność na światło
7 (EN ISO 105-B02:2014)

Certyfikaty trudnopalności
-BS EN 1021:2006 - 1

DE

Zusammensetzung
66% Polyester, 34% Polyamid

Gewicht
210 g/m²

Scheuerfestigkeit
90 000 ± 5% Zyklen Martindale
-PN EN 14465:2005 + A1:2007
-PN EN 12947:2017-02

Lichtechtheit
7 (EN ISO 105-B02:2014)

Feuersicherung
-BS EN 1021:2006 - 1

EN

Composition
66% polyester, 34% polyamid

Weight
210 g/m²

Abrasion Resistance
90 000 ± 5% Martindale cycles
-PN EN 14465:2005 + A1:2007
-PN EN 12947:2017-02

Light Fastness
7 (EN ISO 105-B02:2014)

Flammability
-BS EN 1021:2006 - 1



ŚCIEG OZDOBNY DECORATIVE STICHES DESIGN STEPPUNG



Kod nici:
Code of thread:
Nähte-Kode:

T 1702
biały
white
weiß

T 9573
szary
grey
grau

T 8465
beżowy
beige
beige

T 2517
pomarańczowy
orange
orange

T 0381
czerwony
red
rot

T 0839
zielony
green
grün

Sugerowane dla:
Suggested for:
Vorgeschlagen für:

Tkanin:
Fabrics:
Stoffe:
SKÓRA/ LEATHER/LEDER
KEIMO
VALENCIA
SILVERTEX

Kolekcji:
Collections:
Kolektion:
CEO
DUAL
ELEVEN
IN ACCESS
LUMI
ORTE 3DH
OX:CO
SPIN
UMM
VOO VOO



Przedstawiona kolorystyka nie stanowi oferty w rozumieniu prawa.
The colours presented do not constitute an offer within the meaning of law.
Vorgestellte Farbgebung ist kein Angebot im Sinne der Rechtsvorschriften.



RAL 3005
M - mat/matte/mat



RAL 3020
P - połysk/gloss/Glanz



RAL 2001
M - mat/matte/mat

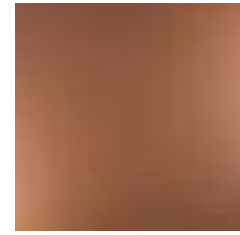

miedz/copper**
P - połysk/gloss/Glanz



RAL 5007
M - mat/matte/mat



RAL 5003
M - mat/matte/mat



RAL 6005
M - mat/matte/mat



gold
P - połysk/gloss/Glanz

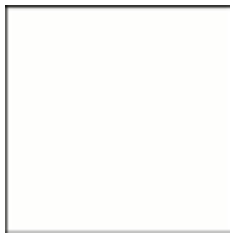

RAL 9010
P - połysk/gloss/Glanz
S* - struktura/structure/
Struktur

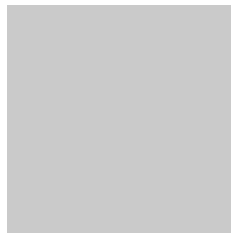

RAL 7047
P - połysk/gloss/Glanz
M - mat/matte/mat
S* - struktura/structure/
Struktur



RAL 7045
M - mat/matte/mat
S* - struktura/structure/
Struktur

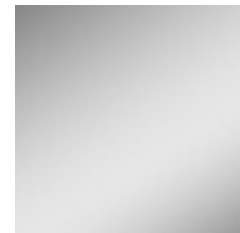

alu
P - połysk/gloss/Glanz



RAL 9005
M - mat/matte/mat
S - struktura/structure/
Struktur



RAL 7024
P - połysk/gloss/Glanz
S* - struktura/structure/
Struktur



chrom

Stolik TB OUT

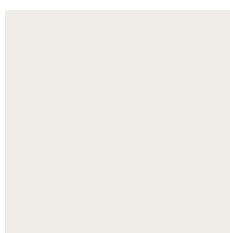

0500



5540



8010

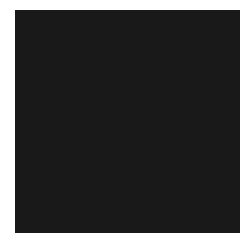

9000

SKY_LINE



SK119



SK155



SK320



SK361



SK509

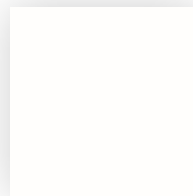

SK916



SK711

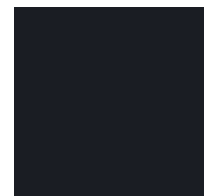

SK917

MORK

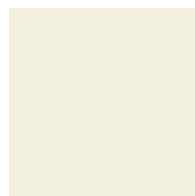

MK901

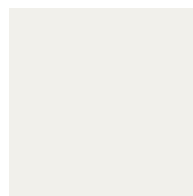

MK903



MK115

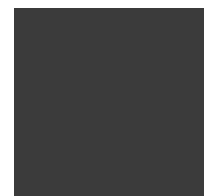

MK721



MK133

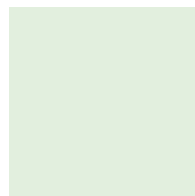

MK619

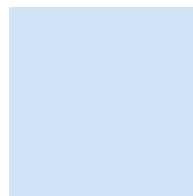

MK524

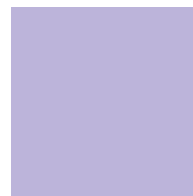

MK405

EGGO

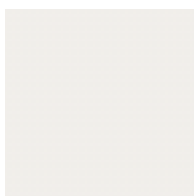

E0500



E6005

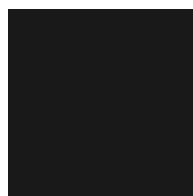

E9000



E6030



E1085



E2060

KYOS

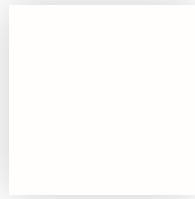

K903



K740



K905

FENDO



FD119



FD300

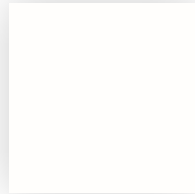

FD903



FD712



FD905

SPLIT



SP554



SP185

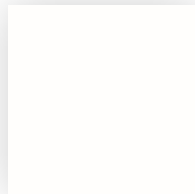

SPO50

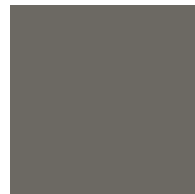

SP605

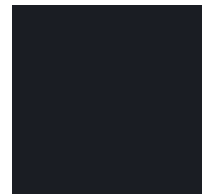

SP900



SP801

SHELL



S115



S208



S327



S617

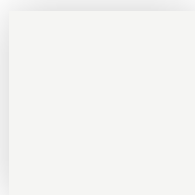

S903



S712



S511



S905

PLASTIK/ KUNSTSTOFF/ PLASTIC

DREWNO LITE BUK - TRES
 BUCHENVOLLHOLZ - TRES
 SOLID BEECH WOOD - TRES



B2
 bielony
 gebleichte
 bleached

B3
 czarny
 schwarz
 black

B5
 biały
 weiß
 white

B6
 szary
 grau
 gray

DREWNO LITE JESION
 ESCHENVOLLHOLZ
 SOLID ASH WOOD

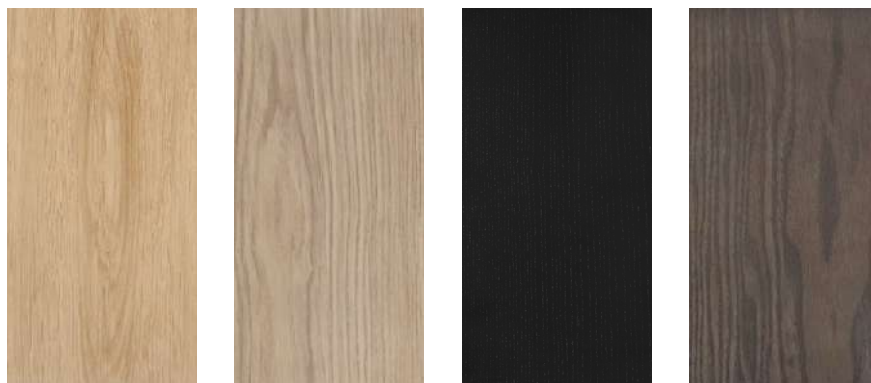

J1
 naturalny
 natürliche
 natural

J2
 bielony
 gebleichte
 bleached

J3
 czarny
 schwarz
 black

J4
 szarobrzązowy
 grau-braun
 gray-brown

DREWNO LITE DĄB
 EICHENVOLLHOLZ
 SOLID OAK WOOD

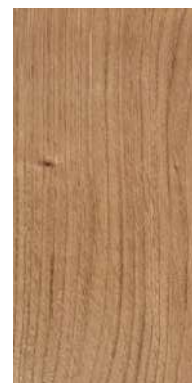

O1
 naturalny
 natürliche
 natural

* Drewno lite dąb tylko pod indywidualne zamówienie (z dłuższym terminem realizacji.) Dopłata zgodna z cennikiem.

* Massives Eichenholz nur auf Bestellung, mit längerer Lieferzeit. Zuschlag gemäß der Preisliste

* Solid oak wood only on demand, with a longer delivery time. Surcharge according to the price list.

PANEL/DREWNO LITE - TREEHOUSE/BEACHHOUSE
 PANEEL/MASSIVHOLZ - TREEHOUSE/BEACHHOUSE
 PANEL/SOLID WOOD - TREEHOUSE/BEACHHOUSE



P1
 sosna/ kiefer/ pine
 naturalna
 natürliche
 natural

P2
 sosna/ kiefer/ pine
 bielona
 gebleichte
 bleached

P3
 sosna/ kiefer/ pine
 czarna
 schwarz
 black

P4
 sosna/ kiefer/ pine
 szarobrzązowa
 grau-braun
 gray-brown

O1
 dąb/ eiche/ oak
 naturalny
 natürliche
 natural

KOLEKCJA KOLLEKTION COLLECTION	MODEL MODELL MODEL	DREWNO LITE JESION	DREWNO LITE DĄB	DREWNO LITE BUK	PANELE PANEL PANELS	
		ESCHENVOLLHOLZ SOLID ASH WOOD	EICHEVOLLHOLZ SOLID OAK WOOD	BUCHENVOLLHOLZ SOLID BEECHWOOD	sosna/ kiefer/ pine	dqb/ kiefer/ oak
		stelaż (nogi jesionowe)/ Massiv Golz Esche Solid ash wood legs	stelaż (nogi dębowe)/ Massiv Golz Eiche Solid oak wood legs	stelaż (nogi bukawe)/ Massiv Golz Buche Solid beech wood legs		
BEACHHOUSE	BH W				•	•
LEAF_POD	LP SFP, LP SFM	•				
LUMI	LM W	•				
OX:CO	OX W	•	•			
ORTE	OT W	•	•			
QUADRA	QD SBG				•	•
MORK	MR W	•				
SKY_LINE	SK W	•	•			
SPIN	SN W	•	•			
TABLES	TB W	•	•			
TB CONFERENCE	TB CONF		•			
TREEHOUSE	TH, THW THS, THSW				•	•
U_FLOE	UFW	•				
UMM	UM W	•				
VIENI	VE W	•	•			
TRES 2	TRES 2			•		

SKLEJKA/ SPERRHOLZ/ PLYWOOD

OKLEINA NATURALNA/ NATURFURNIER/ NATURAL VENEER

KLEJONKA DĘBOWA/ BRETTSCHICHTHOLZ AUS EICHE/ FINGER JOINT SOLID OAK

KLEJONKA SOSNOWA/ BRETTSCHICHTHOLZ AUS PINE/ FINGER JOINT SOLID PINE

SKLEJKA/ SPERRHOLZ/
PLYWOOD

D1

naturalna
natürliche
natural

D3

bielona
gebleichte
bleachedOKLEINA NATURALNA/ NATURFURNIER/
NATURAL VENEER

FDAB

dqb
Eiche
oak

FORZ

orzech amerykański
amerikanischer Nussbaum
American walnutKLEJONKA DĘBOWA/ BRETTSCHICHTHOLZ
AUS EICHE/ FINGER JOINT SOLID OAK

KDAB

dqb / Eiche / oak

KLEJONKA SOSNOWA/ BRETTSCHICHTHOLZ
AUS PINE / FINGER JOINT SOLID PINE

KSOS

sosna / Pine / pine



KOLEKCJA KOLLEKTION COLLECTION	MODEL MODELL MODEL	SKLEJKA SPERRHOLZ PLYWOOD			OKLEINA NATURFURNIER VENEER		KLEJONKA DĘBOWA	KLEJONKA SOSNOWA
		kubelek/ Schale/ schell	podłokietnik/ Armlehne/ armrest	pulpit/blat/ Schreibtischtar/ desktop	orzecz/ Nussbaum/ walnut	dąb/ kiefer/ oak	FINGER JOINT SOLID OAK BRETTSCHICHTHOLZ AUS EICHE	FINGER JOINT SOLID PINE BRETTSCHICHTHOLZ AUS PINE
BOOI	BOS CHAIR W, BO W 4C2, BO W 4Z2, BO W 4L2				•	•		
ORTE	OT 215	•						
	OT 220	•	•	•				
	OT 271	•						
	OT 270	•	•					
	OT 222-225	•						
	OT 4L , OT 2L						•	
	OT H/ HS	•						
	OT W H/ HS	•						
QUADRA	QD SBG						•	•
SAAR	SM SF, SM WW, SM CH, SM PH, SM PF						•	
SPIN	SNP, SNR, SNW						•	
SOCIAL SWING	SSD TB, SSR TB						•	
	SS CHAIR				•	•		
TREEHOUSE	TH, THW						•	•
	THS, THSW						•	•
ZIP	ZP 220		•	•				

SKLEJKA/ SPERRHOLZ/ PLYWOOD

OKLEINA NATURALNA/ NATURFURNIER/ NATURAL VENEER

KLEJONKA DĘBOWA/ BRETTSCHICHTHOLZ AUS EICHE/
FINGER JOINT SOLID OAK

KLEJONKA SOSNOWA/ BRETTSCHICHTHOLZ AUS PINE/
FINGER JOINT SOLID PINE

BLATY/ PLATTE/ TABLETOPS



PLYTA LAMINOWANA - STANDARD / LAMINIERTE PLATTE - STANDARD / LAMINATED TABLETOP - STANDARD



D3798 CL

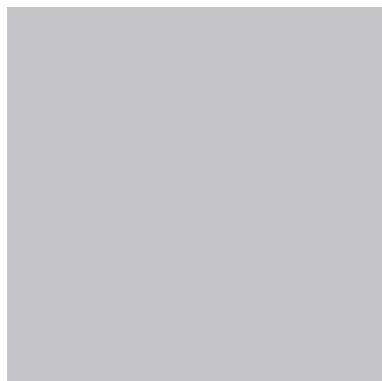

U112 VL

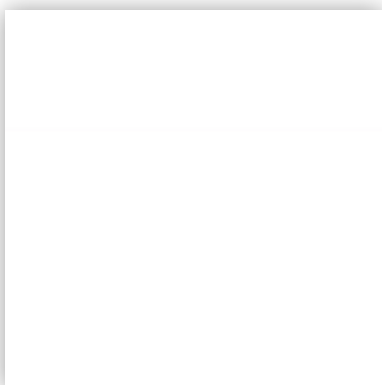

U570 VL

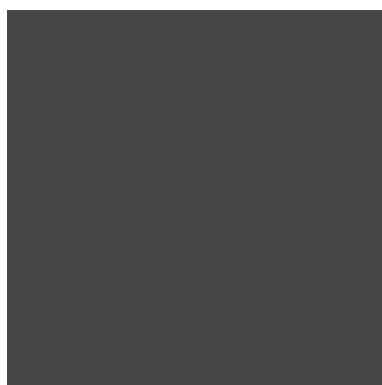

U164 VL

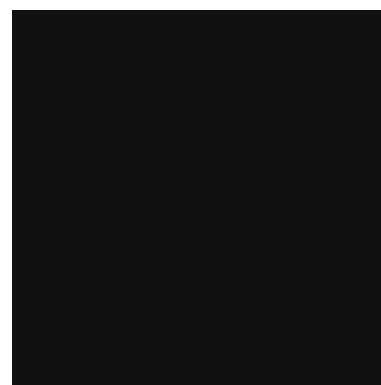

U190 VL

BLAT HPL / HPL PLATTE / HPL TABLETOP

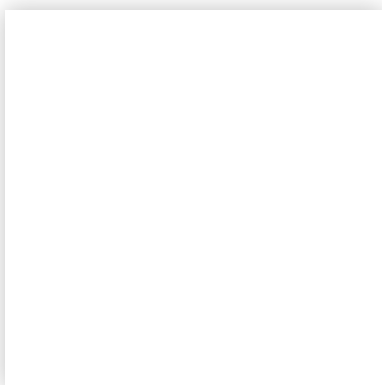

biały / Weiß / white

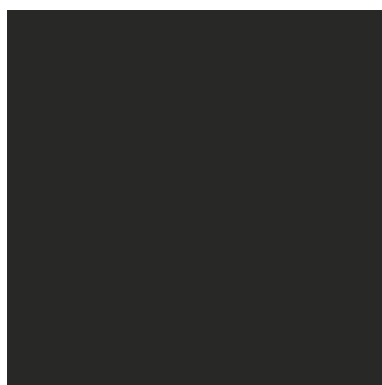

czarny niepalczący
black anti finge print
Schwarz nicht verschmutzendes

LAMINAT / LAMINATE / LAMINAT - ORTE

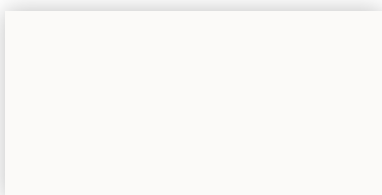

CPL
biały / Weiß / white



CPL
antracyt / Anthrazit / anthracity

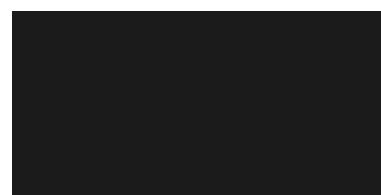

CPL
czarny / Schwarz / black

				PLYTA LAMINOWANA LAMINIERTE PLATTE LAMINATED TABLETOP	HPL
kolekcja Kollektion collection	produkt Produkt product	długość Länge length [mm]	szerokość Breite width [mm]	grubość Dicke thickness [mm]	grubość Dicke thickness [mm]
ACOUSTIC PEAK	AP C1T	Fi 1000		18	10
	AP C2T	2000	1000	18	10
	AP TB	Fi 800		18	10
CAVE	CV TB L	910	800		10
	CV TB H	910	800		10
LEAF_POD	LP LTB, LP CT, LP TB PC			18	10
	LP TB PB			18	
LEGVAN	TS1	1300	700	18	
	TS2	700	700	18	
ORTE	OT 4L	1400	800	25	10
	OT 4L	1600	800	25	10
	OT 4L	2000	1000	25	10
	OT 2L Y	1350	675	25	
	OT 2L T	1350	675	25	
	OT W 4L AA	1400	800	25	10
	OT W 4L AA	1600	800	25	10
	OT W 4L AA	2000	1000	25	10
	OT W 4L AA H	1350	675	25	10
OT 4L A H	1350	675	25	10	
PENTA	PNT 600 B	920	845	18	
QUADRA	QD T690 B	690	690	18	
	QD TB3	1550	750	18	
	QD P1B	630	220	18	
SAAR	SM PF, SM PH, SM SF, SMWW, SM CH			18	
SPIN	SN W TB H	Fi 600		25	
SOCIAL SWING	SSD TB	570	500	18	10
	SSR TB	Fi 1000		25	10
TB	TB W 74 L	Fi 700		18	10
	TB W 74 H	Fi 560		18	10
	TB 29 L	775	670	18	10
	TB 29 H	500	500	18	10
	TB 29R L	Fi 700		18	10
	TB 29R H	Fi 460		18	10
	TB SQ 420	420	420	18	10
	TB SQ 570	570	570	18	10
	TB SQ 800	800	800	18	10
TB EP 1300	1300	570	18	10	
TREEHOUSE	TM	740	580		
	TH	740	580		10
	THD	1410	650	18	10
U_FLOE	UF TB	650	580	18	
	UF BOX+T	420	420		10
	UF TB 45/90/180/180C	660/990/600/600	580/600/600/600		10
	STEP_OVER H/L	1200	600	18	10
	STEP_OVER F	980	220		10
		1255	225		10
UNI	UNI R 460	Fi 460		18	10
	UNI R 560	Fi 560		18	10
	UNI R 700	Fi 700		18	10
VOO VOO	VV TS3	680	500	18	
	VV TS4	1300	700	18	
	VV TS5	700	700	18	
	VV TB3	1800	820	18	
	VV TBC3	1800	820	18	
	VV TB2	1200	820	18	
	VV TBC2	1200	820	18	
	VV WORK	455	340	18	

MOŻLIWOŚCI ZASTOSOWANIA TKANIN W POSZCZEGÓLNYCH PRODUKTACH
 POSSIBILITIES OF USING FABRICS IN INDIVIDUAL PRODUCTS
 VERFÜGBARKEIT VON STOFFEN FÜR EINZELNE PRODUKTE

● Kropka oznacza, że produkt występuje w danej tkaninie.
 A point means that the product can be made in the fabric.
 Das Produkt ist im angezeigten Stoff erhältlich.

	BOND	FENNO	KEIMO	NICE	SAWANA	CHARLES	ERA	FIGHTER	PASTEL	ROCCIA	SAWANA PIK	VALENCIA
ACOUSTIC PEAK	●	●	●			●		●	●	●		
BEACHHOUSE		●						●	●	●	●	
BOOI		●				●		●	●	●	●	●
BOOI WORKSTATION siedzisko/seat/Sitz		●				●		●	●	●	●	
BOOI WORKSTATION ściana/wall/Wand		●			●	●		●	●	●	●	
CAVE modułowy/modular		●				●			●	●	●	
CAVE 9XX		●				●			●	●	●	
CEO												
CLUBIN	●	●	●		●	●		●	●	●	●	
CORR	●	●	●	●	●	●	●	●	●	●	●	●
CUBE	●	●	●		●	●		●	●	●	●	●
CUBE 3D	●	●	●		●			●	●	●		●
DUAL	●	●	●	●	●	●	●	●	●	●	●	●
EGGO	●	●	●	●	●	●	●	●	●	●	●	●
ELEVEN	●	●	●	●	●	●	●	●	●	●	●	●
EPOCC	●	●	●		●	●	●	●	●	●	●	●
FENDO	●	●	●		●	●		●	●	●	●	●
IN ACCESS		●	●		●	●		●	●	●	●	●
KYOS	●	●	●	●	●	●	●	●	●	●	●	●
LEAF_POD ściana/wall/Wand												
LEAF_POD sofa/sofa	●	●	●		●	●	●	●	●	●	●	●
LEGVAN	●	●	●		●	●		●	●	●	●	●
LIFT	●	●	●	●	●	●	●	●	●	●	●	●
LUMI	●	●	●		●	●	●	●	●	●	●	●
MATE	●	●	●	●	●	●	●	●	●	●	●	●
MILLA	●	●	●	●	●	●	●	●	●	●	●	●
MOMO	●	●	●	●	●	●	●	●	●	●	●	●
MOMO 1T2	●	●						●	●	●		
MORK 2N	●	●	●	●	●	●	●	●	●	●	●	●
ORTE 2N/3N	●	●	●	●	●	●	●	●	●	●	●	●
ORTE 3D	●	●	●		●	●	●	●		●		●
ORTE 4N	●	●	●	●	●	●	●	●	●	●	●	●
OX:CO	●	●	●		●	●	●	●	●	●	●	●
	1 grupa cenowa / price group / Preisgruppe					2 grupa cenowa / price group / Preisgruppe						

MOŻLIWOŚCI ZASTOSOWANIA TKANIN W POSZCZEGÓLNYCH PRODUKTACH
 POSSIBILITIES OF USING FABRICS IN INDIVIDUAL PRODUCTS
 VERFÜGBARKEIT VON STOFFEN FÜR EINZELNE PRODUKTE

● Kropka oznacza, że produkt występuje w danej tkaninie.
 A point means that the product can be made in the fabric.
 Das Produkt ist im angezeigten Stoff erhältlich.

VALENCIA SD	BLAZER	CRISP	FAME	SILVERTEX	SYNERGY	REMIX	SKÓRA LEATHER LEDER	HERITAGE	ACCESSOIRE	STEELCUT		
	●	●	●		●	●				●	ACOUSTIC PEAK	
	●	●	●		●	●				●	BEACHHOUSE	
●	●	●	●		●	●	●	●		●	BOOI	
	●	●	●		●	●	●	●		●	BOOI WORKSTATION siedzisko/seat/Sitz	
	●	●	●		●	●		●		●	BOOI WORKSTATION ścianka/wall/Wand	
	●	●	●		●	●			●	●	CAVE modułowy/modular	
	●	●	●		●	●	●	●	●	●	CAVE 9XX	
	●	●	●		●	●	●				CEO	
	●	●	●	●	●	●	●	●	●	●	CLUBIN	
●	●	●	●	●	●	●	●	●	●	●	CORR	
●	●	●	●	●	●	●	●	●	●	●	CUBE	
●	●	●	●	●	●	●	●				CUBE 3D	
●	●	●	●	●	●	●	●	●		●	DUAL	
●	●	●	●	●	●	●	●	●	●	●	EGGO	
●	●	●	●	●	●	●	●	●	●	●	ELEVEN	
●	●	●	●	●	●	●	●	●	●	●	EPOCC	
●	●	●	●	●	●	●	●	●		●	FENDO	
●	●	●	●	●	●	●	●	●	●	●	IN ACCESS	
●	●	●	●	●	●	●	●	●	●	●	KYOS	
	●				●						LEAF_POD ścianka/wall/Wand	
●	●	●	●	●	●	●	●	●	●	●	LEAF_POD sofa/sofa	
●	●	●	●	●	●	●	●	●	●	●	LEGVAN	
●	●	●	●	●	●	●	●	●	●	●	LIFT	
●	●	●	●	●	●	●	●	●	●	●	LUMI	
●	●	●	●	●	●	●	●	●	●	●	MATE	
●	●	●	●	●	●	●	●	●	●	●	MILLA	
●	●	●	●	●	●	●	●	●	●	●	MOMO	
		●				●		●		●	MOMO 1T2	
●	●	●	●	●	●	●	●	●	●	●	MORK 2N	
●	●	●	●	●	●	●	●	●	●	●	ORTE 2N/3N	
●	●	●		●	●	●	●				ORTE 3D	
●	●	●	●	●	●	●	●	●		●	ORTE 4N	
●	●	●	●	●	●	●	●	●	●	●	OX:CO	
3 grupa cenowa / price group / Preisgruppe						4 grupa cenowa / price group / Preisgruppe			5 grupa cenowa / price group / Preisgruppe			

MOŻLIWOŚCI ZASTOSOWANIA TKANIN W POSZCZEGÓLNYCH PRODUKTACH
 POSSIBILITIES OF USING FABRICS IN INDIVIDUAL PRODUCTS
 VERFÜGBARKEIT VON STOFFEN FÜR EINZELNE PRODUKTE

● Kropka oznacza, że produkt występuje w danej tkaninie.
 A point means that the product can be made in the fabric.
 Das Produkt ist im angezeigten Stoff erhältlich.

	BOND	FENNO	KEIMO	NICE	SAWANA	CHARLES	ERA	FIGHTER	PASTEL	ROCCIA	SAWANA PIK	VALENCIA
PENTA	●	●	●		●	●		●	●	●	●	●
PENTA ścianka/wall/Wand	●	●			●	●		●	●	●	●	
POINT	●	●	●		●	●		●	●	●	●	●
POINT 3D	●	●	●		●	●		●	●	●		●
QUADRA	●	●	●		●	●		●	●	●	●	●
QUADRA PHONEBOX	●	●			●	●		●	●	●		
QUADRA SHA		●						●	●	●	●	
QUADRA ścianka/wall/Wand	●	●			●	●		●	●	●	●	
QUADRA STANDING BOX GLASS		●				●		●	●	●	●	
SAAR	●	●	●	●	●	●	●	●	●	●	●	●
ROLLWALL	●	●	●		●	●		●	●	●	●	
SELVA DESK / HANG / FREE / SKY / WALL	●	●			●	●	●	●	●	●	●	
SELVA POD / TOWER	●	●			●	●		●	●	●	●	
SHELL	●	●	●	●	●	●	●	●	●	●	●	●
SILENT BLOCK	●	●			●	●	●	●	●	●	●	
SKY_LINE	●	●	●	●	●	●	●	●	●	●	●	●
SOCIAL SWING siedzisko/seat/Sitz	●	●	●		●	●	●	●	●	●	●	
SOCIAL SWING DOUBLE / ROUND	●	●			●			●	●	●		
SOCIAL SWING ławka/bench/Bank	●	●	●		●	●		●	●	●	●	
SPIN SNR / SNR LU	●	●	●	●	●	●	●	●	●	●	●	●
STRING	●	●	●	●	●	●	●	●	●	●	●	●
TREEHOUSE		●				●		●	●	●	●	●
TREEHOUSE ścianka tylna / back wall / Rückwand		●						●	●	●	●	●
TREEHOUSE STAND SINGLE 2G		●				●		●	●	●	●	
TREEHOUSE DOUBLE GLASS 1G		●				●		●	●	●	●	
U_FLOE	●	●	●		●	●		●	●	●	●	●
U_FLOE ścianka/wall/Wand	●	●			●	●		●	●	●	●	
UMM		●				●		●	●	●		
VECTOR	●	●	●		●	●		●	●	●	●	●
VIENI		●				●		●	●	●		●
VOO VOO		●	●		●	●			●	●	●	●
VOO VOO 9xx / 9xx Box		●	●		●	●			●	●	●	●
ZIP	●	●	●	●	●	●	●	●	●	●	●	●

1 grupa cenowa / price
group / Preisgruppe

2 grupa cenowa / price
group / Preisgruppe

MOŻLIWOŚCI ZASTOSOWANIA TKANIN W POSZCZEGÓLNYCH PRODUKTACH
 POSSIBILITIES OF USING FABRICS IN INDIVIDUAL PRODUCTS
 VERFÜGBARKEIT VON STOFFEN FÜR EINZELNE PRODUKTE

● Kropka oznacza, że produkt występuje w danej tkaninie.
 A point means that the product can be made in the fabric.
 Das Produkt ist im angezeigten Stoff erhältlich.

VALENCIA SD	BLAZER	CRISP	FAME	SILVERTEX	SYNERGY	REMIX	SKÓRA LEATHER LEDER	HERITAGE	ACCESSOIRE	STEELCUT		
●	●	●	●	●	●	●	●	●	●	●	PENTA	
	●	●	●		●	●				●	PENTA ścianka/wall/Wand	
●	●	●	●	●	●	●	●	●	●	●	POINT	
●	●	●	●	●	●	●	●				POINT 3D	
●	●	●	●	●	●	●	●	●	●	●	QUADRA	
	●	●	●		●	●				●	QUADRA PHONEBOX	
	●	●	●		●	●				●	QUADRA SHA	
	●	●	●		●	●				●	QUADRA ścianka/wall/Wand	
	●	●	●		●	●				●	QUADRA STANDING BOX GLASS	
●	●	●	●	●	●	●	●	●	●	●	SAAR	
	●	●	●		●	●			●	●	ROLLWALL	
	●	●	●		●	●		●	●	●	SELVA DESK / HANG / FREE / SKY / WALL	
	●	●	●		●	●		●		●	SELVA POD / TOWER	
●	●	●	●	●	●	●	●	●	●	●	SHELL	
	●	●	●		●	●		●	●	●	SILENT BLOCK	
●	●	●	●	●	●	●	●	●	●	●	SKY_LINE	
	●	●	●	●	●	●	●	●		●	SOCIAL SWING siedzisko/seat/Sitz	
	●	●	●		●	●				●	SOCIAL SWING DOUBLE / ROUND	
	●	●	●		●	●		●		●	SOCIAL SWING ławka/bench/Bank	
●	●	●	●	●	●	●	●	●	●	●	SPIN SNR / SNR LU	
●	●	●	●	●	●	●	●	●	●	●	STRING	
●	●	●	●	●	●	●			●	●	TREEHOUSE	
●	●	●	●	●	●	●				●	TREEHOUSE ścianka tylna / back wall / Rückwand	
	●	●	●		●	●		●	●	●	TREEHOUSE STAND SINGLE 2G	
	●	●	●		●	●		●	●	●	TREEHOUSE DOUBLE GLASS 1G	
●	●	●	●	●	●	●	●	●	●	●	U_FLOE	
	●	●	●		●	●				●	U_FLOE ścianka/wall/Wand	
	●	●	●		●	●	●	●		●	UMM	
●	●	●	●	●	●	●	●	●	●	●	VECTOR	
●	●	●	●	●	●	●	●	●	●	●	VIENI	
●	●	●		●	●	●	●	●		●	VOO VOO	
●	●	●		●	●	●	●			●	VOO VOO 9xx / 9xx Box	
●	●	●	●	●	●	●	●	●	●	●	ZIP	
3 grupa cenowa / price group / Preisgruppe						4 grupa cenowa / price group / Preisgruppe			5 grupa cenowa / price group / Preisgruppe			



RAL 3005
M - mat/matte/mat



RAL 3020
P - połysk/gloss/Glanz

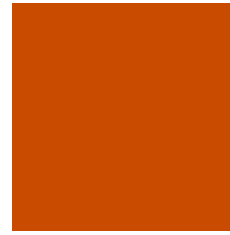

RAL 2001
M - mat/matte/mat



miedz/copper**
P - połysk/gloss/Glanz

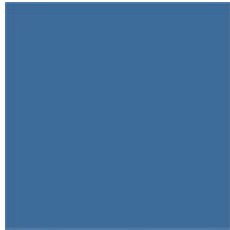

RAL 5007
M - mat/matte/mat



RAL 5003
M - mat/matte/mat



RAL 6005
M - mat/matte/mat



gold
P - połysk/gloss/Glanz

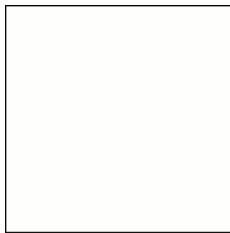

RAL 9010
P - połysk/gloss/Glanz
S* - struktura/structure/
Struktur

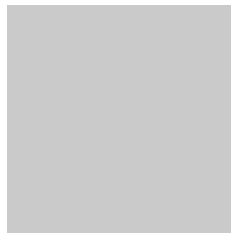

RAL 7047
P - połysk/gloss/Glanz
M - mat/matte/mat
S* - struktura/structure/
Struktur



RAL 7045
P - połysk/gloss/Glanz
M - mat/matte/mat
S* - struktura/structure/
Struktur

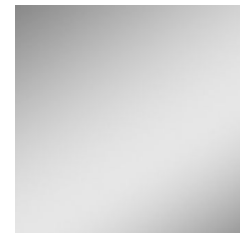

alu
P - połysk/gloss/Glanz

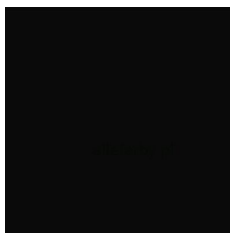

RAL 9005
M - mat/matte/mat
S - struktura/structure/
Struktur



RAL 7024
P - połysk/gloss/Glanz
M - mat/matte/mat
S* - struktura/structure/
Struktur



chrom

Stolik TB OUT

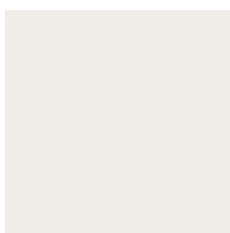

0500



5540



8010

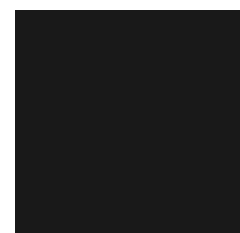

9000

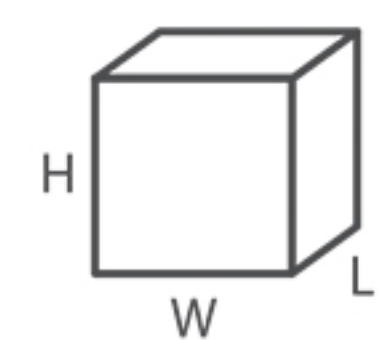
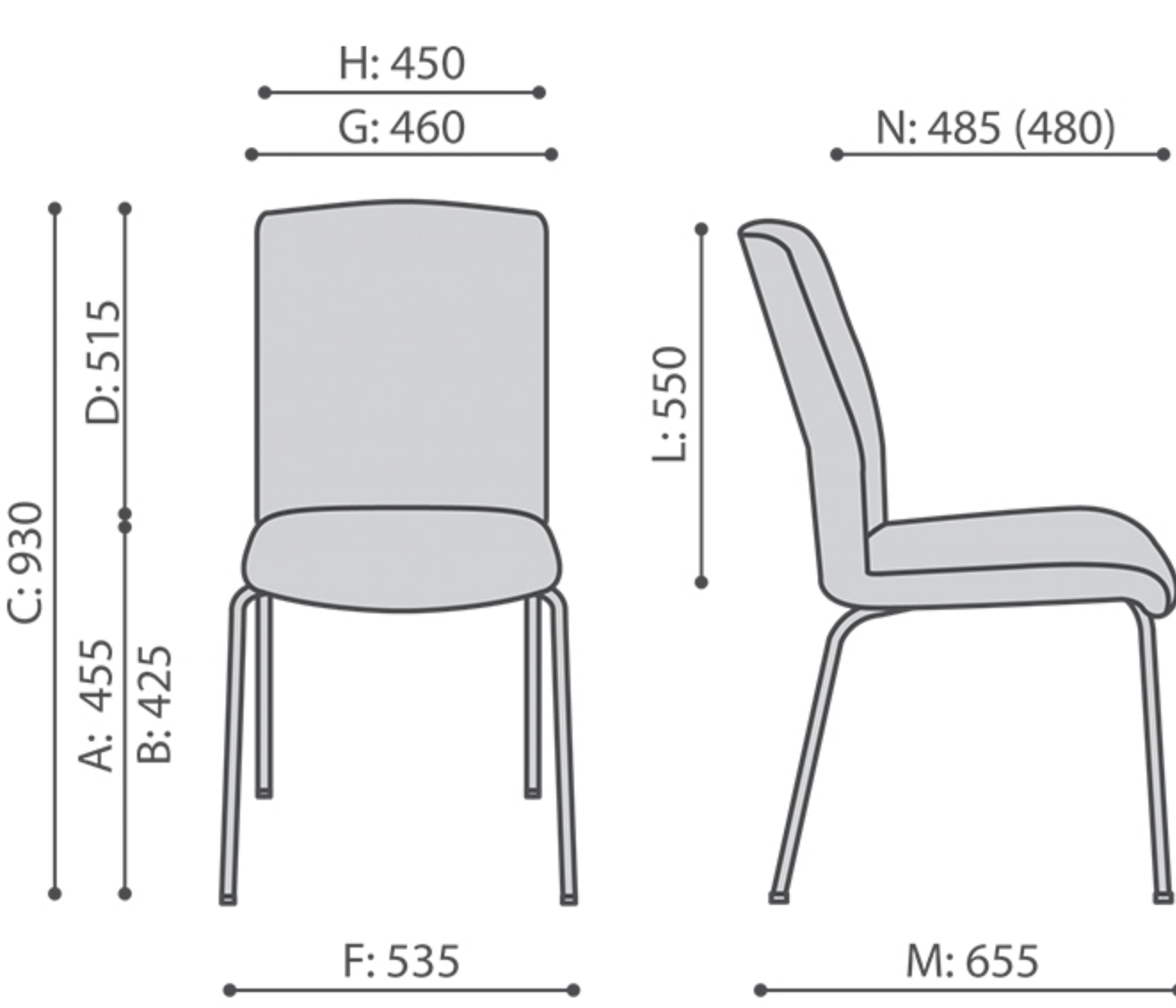

H: 970
W: 660
L: 610

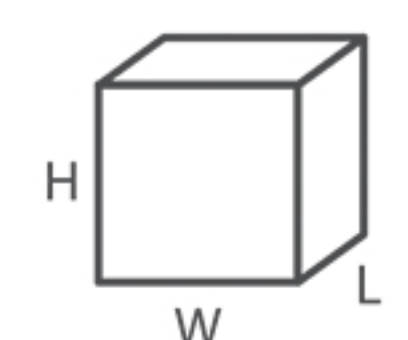
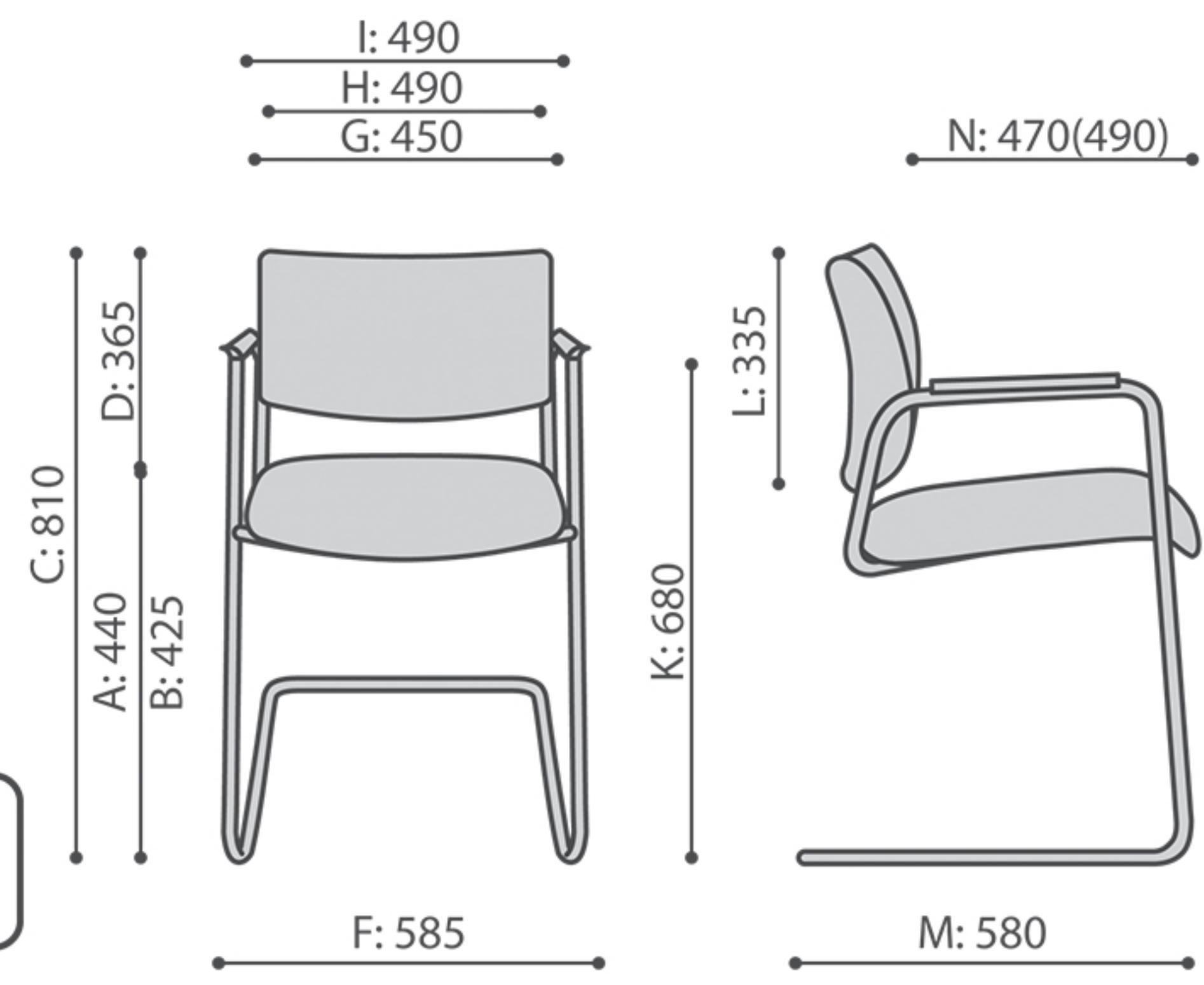
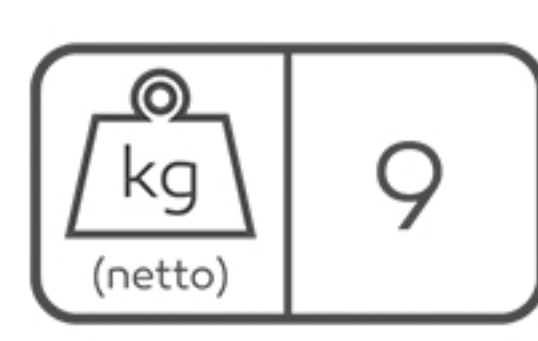

H: 880
W: 620
L: 580

H: 970
W: 660
L: 610



ZP 21H

ZP 230

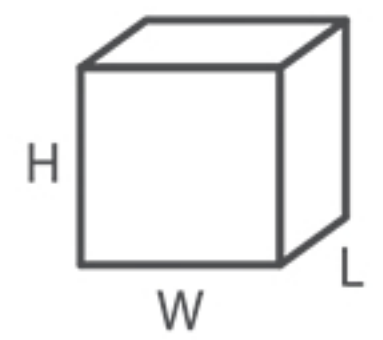
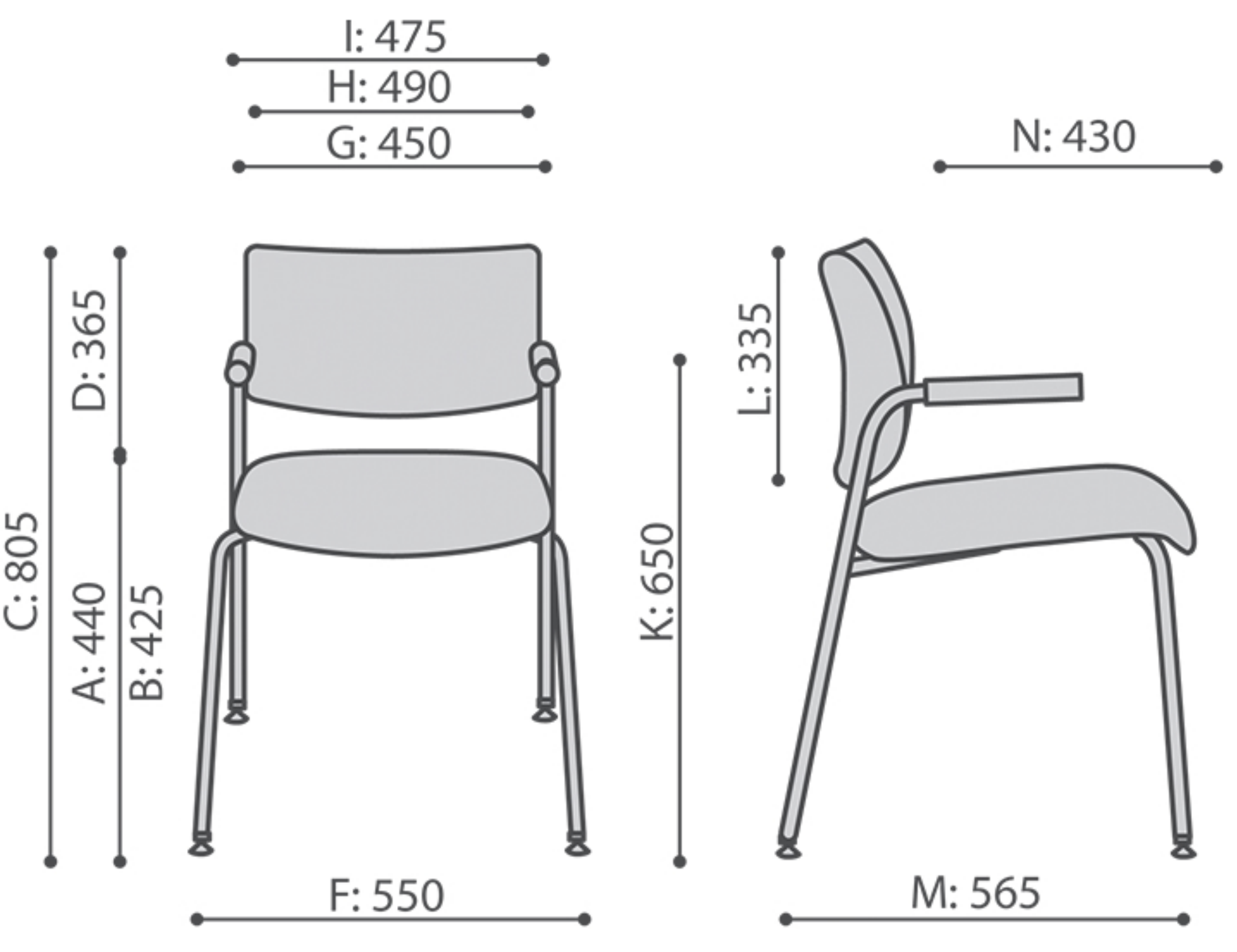

H: 880
W: 620
L: 580

H: 970
W: 660
L: 610

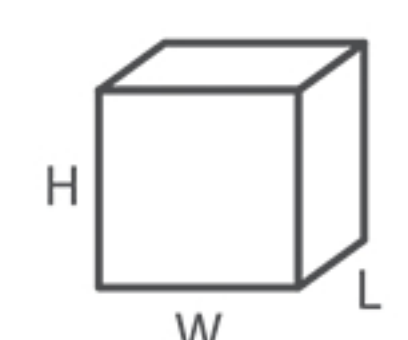
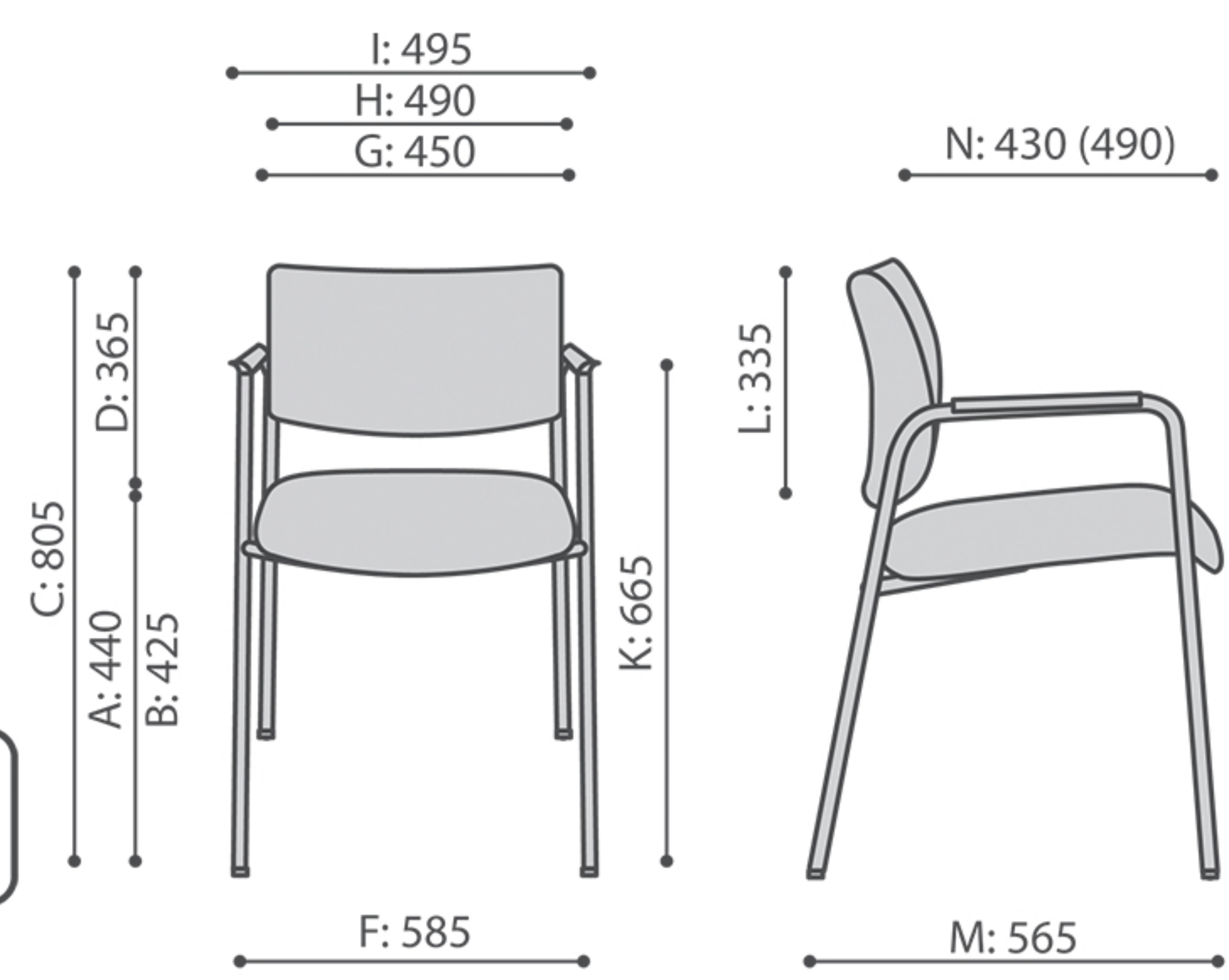

H: 880
W: 620
L: 580

H: 970
W: 660
L: 610

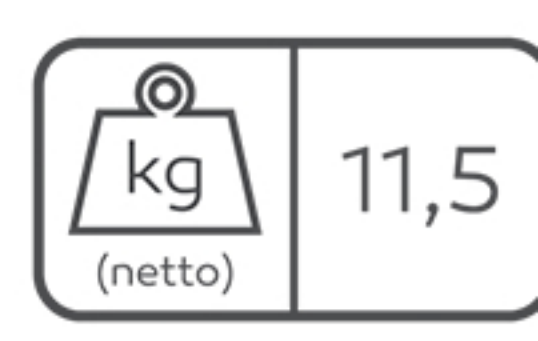

ZP 221

ZP 220

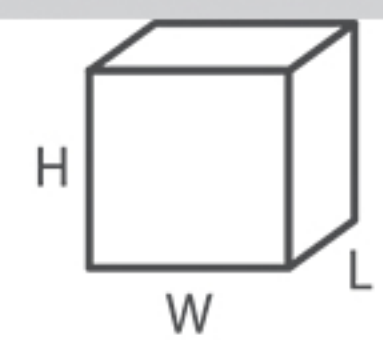
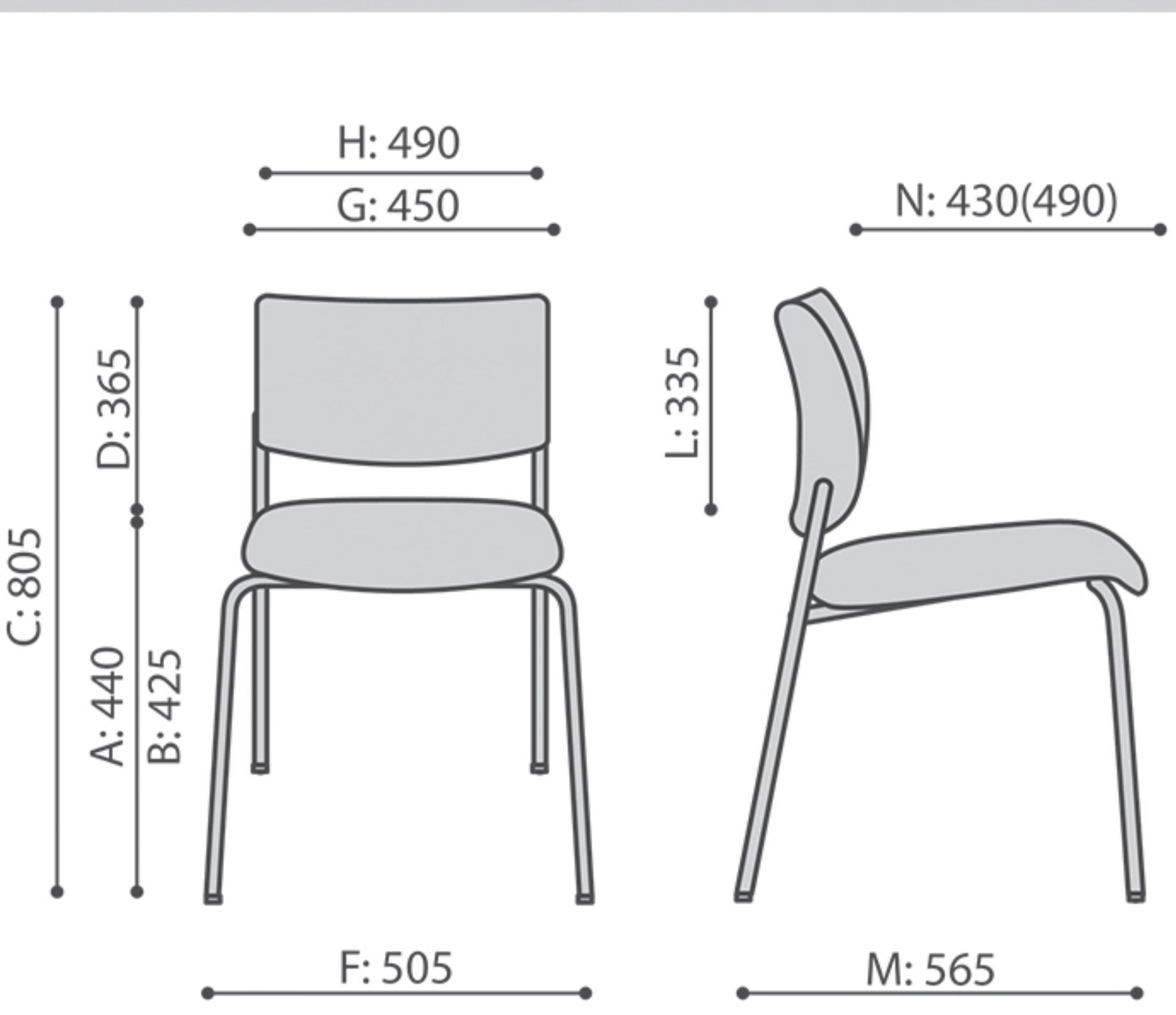

H: 880
W: 620
L: 580

H: 970
W: 660
L: 610

H: 1070
W: 660
L: 610

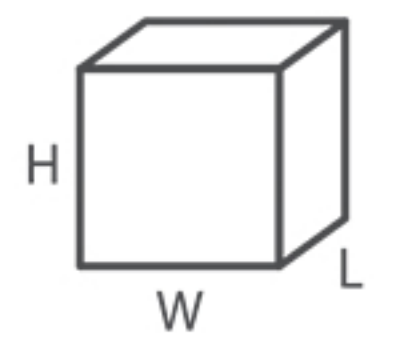
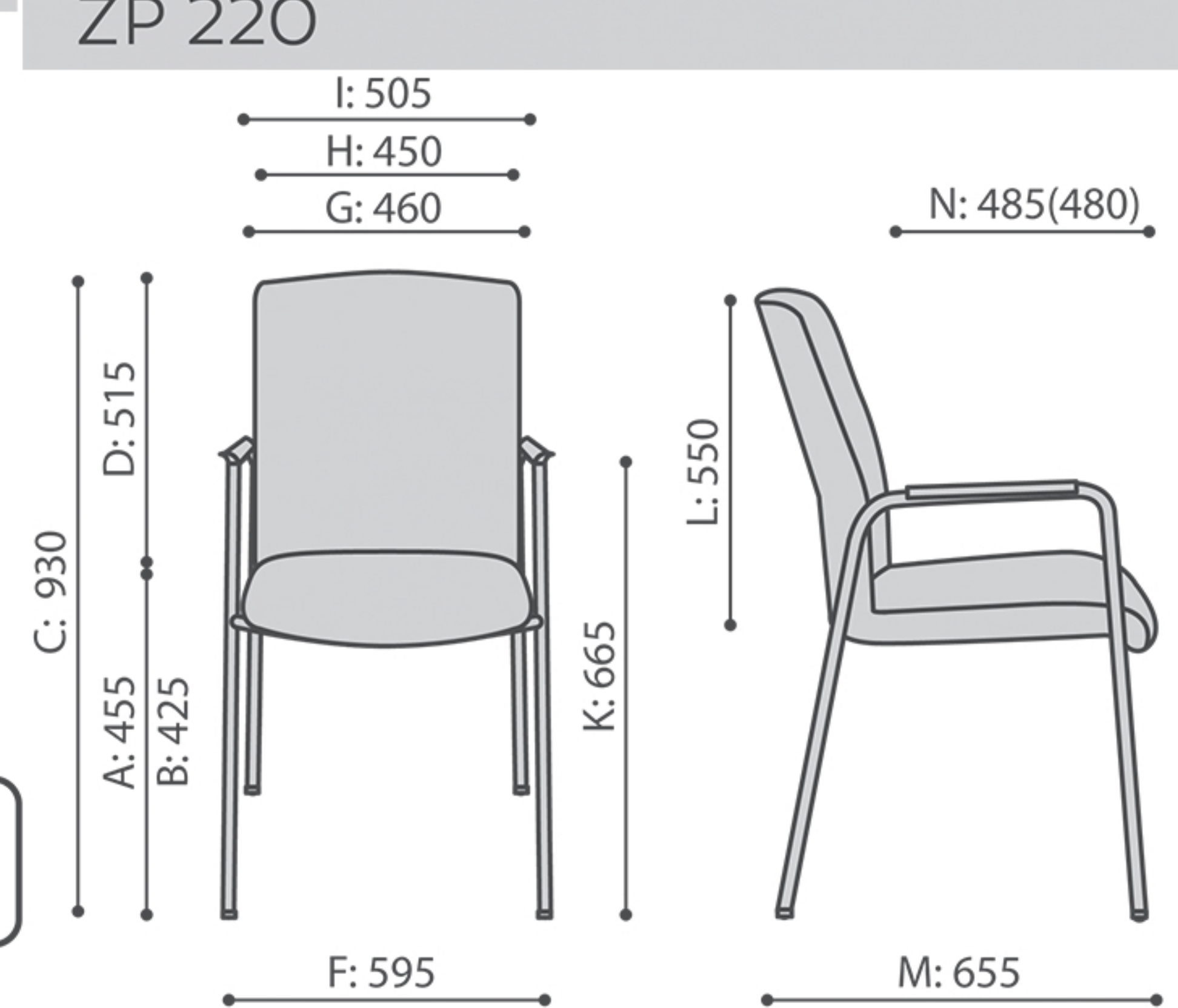
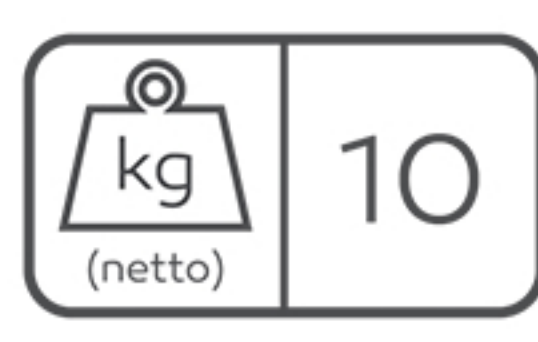

H: 960
W: 660
L: 610

H: 1060
W: 660
L: 610



ZP 215

ZP 22H