

SOAVE

Soave

Family

Armchair / Sofa

Designer

Sebastian Herkner / 2018

Link

www.read-mo.re/soave



PRODUCT SHEET

Dati tecnici · Technical data · Données techniques · Technische Angaben

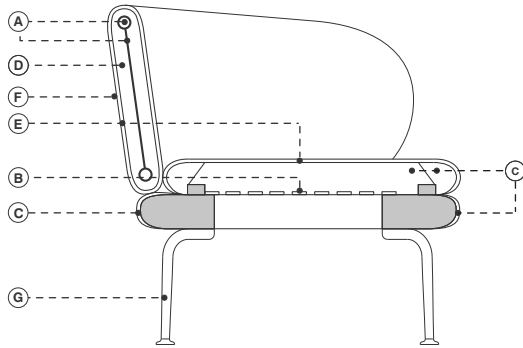

■ Legno massiccio di faggio

- A. Acciaio
- B. Cinghie elastiche ad alta densità
- C. Poliuretano espanso ignifugo indeformabile a quote differenziate
- D. Poliuretano ignifugo schiumato a freddo
- E. Fibra di poliestere
- F. Rivestimento fisso in tessuto o pelle
- G. Acciaio verniciato

■ Solid beech

- A. Steel
- B. High density elastic straps
- C. Flame-retardant undeformable polyurethane foam of different densities
- D. Injected flame-retardant foam
- E. Polyester fibers
- F. Fixed upholstery in fabric or leather
- G. Lacquered steel

■ Bois de hêtre massif

- A. Acier
- B. Sangles élastiques à haute densité
- C. Mousse polyuréthane expansé ignifuge indeformable à épaisseurs différenciées
- D. Mousse à froid ignifuge
- E. Fibre de polyester
- F. Revêtement pas déhoussable en tissu
- G. Acier laqué

■ Massivholz Buche

- A. Stahl
- B. Elastische Gurtbänder
- C. Feuerfester formbeständiger Polyurethanschaum in unterschiedlicher Dichte
- D. Feuerbeständiger Kaltschaum
- E. Polyester
- F. Unabziehbarer Bezug aus Stoff oder Leder
- G. Lackierter Stahl

Note · Notes · Annotation · Anmerkung

- Piedi personalizzabili con tinta cliente
- Cuscini extra disponibili
- COM: tessuto cliente (tinta unita e h.140 cm.) - campione richiesto
- COL: pelle cliente - campione richiesto
- CAT. SPECIAL: prezzo e disponibilità su richiesta

- Feet customizable with customer's colors on request
- Extra cushions available
- COM: client's fabric (plain colour and width 140 cm.) - sample required
- COL: client's leather - sample required
- CAT. SPECIAL: price and availability upon request

- Pieds personnalisable avec coloris du sur demande
- Autres coussins disponibles
- COM: tissu fourni (couleur unie et hauteur 140 cm.) - échantillon nécessaire
- COL: cuir fourni - échantillon nécessaire
- CAT. SPECIAL: prix et disponibilité sur demande

- Füße in Kundenfarben auf Anfrage verfügbar
- Weitere Kissen verfügbar
- COM: Kundenstoff (einfarbig und Breite 140 cm.) - Stoffmuster nötig
- COL: Kundenleder - Ledermuster nötig
- CAT. SPECIAL: Preis und Verfügbarkeit auf Anfrage

Finiture piedi · Feet finishes · Finitions de pieds · Füße Ausführungen



Nero pece
Pitch black
Poix noir
Pech Schwarz



Prugna
Plum
Prune
Pflaume



Laccato ottone
Lacquered brass
Laqué laiton
Messing lackiert



Laccato rame
Lacquered copper
Laqué cuivre
Kupfer lackiert

Finiture piano tavolo · Tables top finishes · Finitions de plateau de table · Tischplatten Ausführungen



Rovere spazzolato naturale
Natural brushed oak
Chêne brossé naturel
Eichenholz Natural gebürstet



Rovere spazzolato grafite
Graphite brushed oak
Chêne brossé graphite
Eichenholz Graphit gebürstet



MDF Bianco (RAL 9016)
MDF White (RAL 9016)
MDF Blanc (RAL 9016)
MDF Weiß (RAL 9016)



MDF Nero (RAL 9005)
MDF Black (RAL 9005)
MDF Noir (RAL 9005)
MDF Schwarz (RAL 9005)



Marmo Marquina
Marquina marble
Marbre Marquina
Marquina Marmor



Marmo Carrara
Carrara marble
Marbre Carrara
Carrara Marmor



Marmo Calacatta
Calacatta marble
Marbre Calacatta
Calacatta Marmor

Rivestimenti consigliati · Recommended coverings · Revêtements conseillées · Empfohlene Bezüge

- cat. A XTREME
- cat. A STEP
- cat. A ANGEL
- cat. A MEDLEY
- cat. A MOOD
- cat. A CRAZY
- cat. B EXTREMA
- cat. B IKON
- cat. B SILVERTEX
- cat. B SAMAR
- cat. B FAME
- cat. B MAIN LINE FLAX

- cat. C TREND
- cat. C SUPERB
- cat. C HESTAN
- cat. C DEANS
- cat. super REMIX 3
- cat. super CAPTURE
- cat. super MODA
- cat. super REVIVE 1
- cat. super BREEZE FUSION

- cat. extra MOLLY
- cat. extra RIME
- cat. extra STEELCUT TRIO 3
- cat. extra ARIANA
- cat. extra COLLINE
- cat. extra OPERA
- cat. extra DANTE
- cat. extra ARCO
- cat. maxi UNIFORM MÉLANGE
- cat. maxi HALLINGDAL 65
- cat. maxi COMFORT
- cat. maxi DIVINA 3

- cat. lux LUX 1
- cat. lux LUX 2
- cat. imperial IMPERIAL 1
- cat. imperial IMPERIAL 2
- cat. imperial NABUK
- cat. special DROP

SOAVE

cod. 1030 / **armchair**

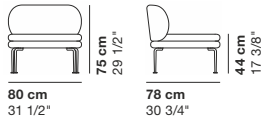

cod. 1031 / **armchair with arms**

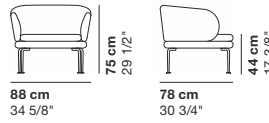

cod. 1032 / **2 seater**

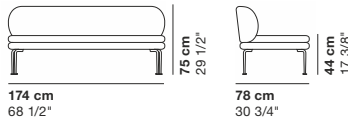

cod. 1033 / **2 seater with arms**

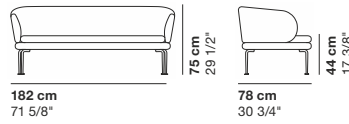

cod. 1034 / **3 seater**

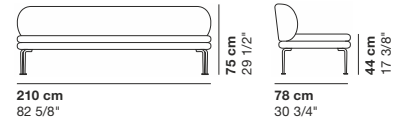

cod. 1035 / **3 seater with arms**

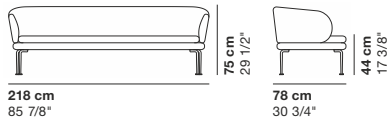

cod. 1036 / **right element 178**

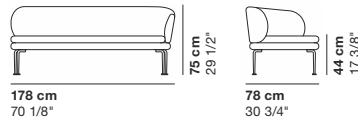

cod. 1037 / **left element 178**

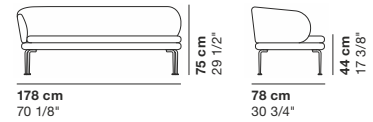

cod. 1038 / **right element 214**

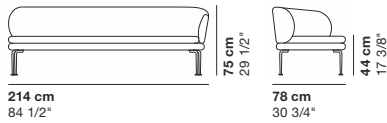

cod. 1039 / **left element 214**

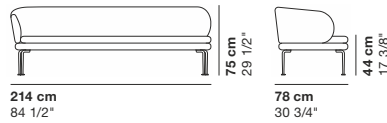

cod. 1040 / **element 174 with right table**

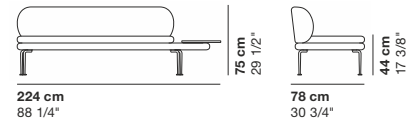

cod. 1041 / **element 174 with left table**

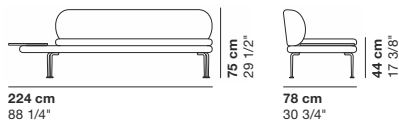

cod. 1042 / **right element 178 with left table**



cod. 1043 / **left element 178 with right table**

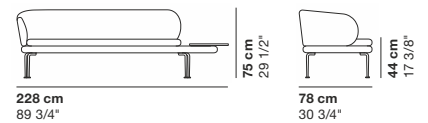

cod. 1031HIGH / **high armchair**

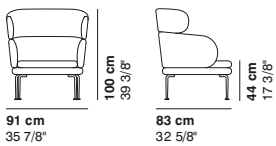

cod. 1033HIGH / **high 2 seater**

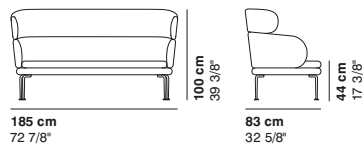

cod. 1035HIGH / **high 3 seater**

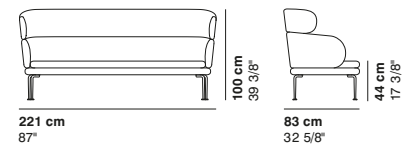

La Cividina s.r.l., al fine di migliorare caratteristiche tecniche e qualitative della sua produzione, si riserva di apportare, anche senza preavviso, tutte le modifiche che si rendessero necessarie.

With a view to improving the technical characteristics and quality of its products, La Cividina s.r.l. reserves the right to develop its products at anytime without notice.

Afin d'améliorer les caractéristiques techniques et qualitatives de sa production, La Cividina s.r.l. se réserve d'apporter, même sans préavis, toutes les modifications qui se rendront nécessaires.

Zur Verbesserung der technischen und qualitativen Merkmale, behält sich La Cividina s.r.l. vor, alle notwendig erscheinenden Produktionsänderungen, auch ohne Vorankündigung durchzuführen.



ISO 9001

LaCividina srl

**HEADQUARTERS
/ PRODUCTION**

Via Cividina 176
33035 Martignacco
Udine Italy

SHOWROOM

Via Lungolavia 1
33035 Martignacco
Udine Italy

T. + 39 0432 677433

F. + 39 0432 677480

info@lacividina.com

www.lacividina.com

VAT nr. IT01810870301