Why Not

Family

Sofa / Bench / System

Designer

Luca Botto / 2010

Link

www.read-mo.re/why_not



WHY NOT

Dati tecnici · Technical data · Données techniques · Technische Angaben

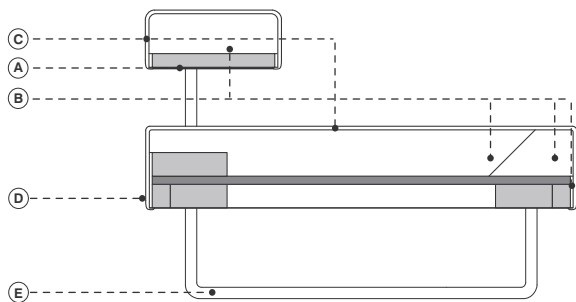

■ Legno massiccio di faggio	■ Solid beech	■ Bois de hêtre massif	■ Massiveholz aus Buche
■ Multistrato di faggio	■ Multilayered beech	■ Multiplis de hêtre	■ Buchenschichtholz
A. Pannello di masonite	A. Masonite panels	A. Panneau de particules	A. Holzfaserplatte
B. Poliuretano espanso ignifugo indeformabile a quote differenziate	B. Flame-retardant undeformable polyurethane foam of different densities	B. Mousse polyuréthane expansé ignifuge indéformable à épaisseurs différenciées	B. Feuerfester formbeständige Polyurethanschaum in unterschiedlicher Dichte
C. Fibra di poliestere	C. Polyester fibers	C. Fibre de polyester	C. Polyester
D. Rivestimento fisso in tessuto o pelle	D. Fixed upholstery in fabric or leather	D. Revêtement pas déhoussable en tissu ou cuir	D. Unabziehbarer Bezug aus Stoff oder Leder
E. Acciaio	E. Steel	E. Acier	E. Stahl

Note · Notes · Annotation · Anmerkung

<ul style="list-style-type: none"> • Base personalizzabile con tinta cliente • Prodotto disponibile su misura con preventivo su richiesta • Su richiesta attacco per connessione elettrica e USB con sovrapprezzo • Cuscini extra disponibili • COM: tessuto cliente (tinta unita e h.140 cm.) - campione richiesto • COL: pelle cliente - campione richiesto • CAT. SPECIAL: prezzo e disponibilità su richiesta 	<ul style="list-style-type: none"> • Base customizable with customer's colors on request • This item can be tailor made with price on request • Electrical connection and USB upon request with upcharge • Extra cushions available • COM: client's fabric (plain colour and width 140 cm.) - sample required • COL: client's leather - sample required • CAT. SPECIAL: price and availability on request 	<ul style="list-style-type: none"> • Piètement disponible en autres finitions sur demande • Collection personnalisable sur demande • Sur demande connection électrique et USB avec surcoût • Autres coussins disponibles • COM: tissu fourni (couleur unie et hauteur 140 cm.) - échantillon nécessaire • COL: cuir fourni - échantillon nécessaire • CAT. SPECIAL: prix et disponibilité sur demande 	<ul style="list-style-type: none"> • Gestell in Kundenfarben auf Anfrage verfügbar • Produkt nach Maß verfügbar auf Anfrage • Elektrische Verbindung und USB-Anschluss auf Anfrage gegen Aufpreis • Weitere Kissen verfügbar • COM: Kundenstoff (einfarbig und Breite 140 cm.) - Stoffmuster nötig • COL: Kundenleder - Ledermuster nötig • CAT. SPECIAL: Preis und Verfügbarkeit auf Anfrage
--	--	--	--

Finiture base · Base finishes · Finitions piètement · Gestell Ausführungen



Cromato lucido
Polished chrome steel
Acier chromé brillant
Stahl Chrom poliert



Nero (RAL 9005)
Black (RAL 9005)
Noir (RAL 9005)
Schwarz (RAL 9005)

Sistema di aggancio · System connector · Systeme d'assemblage · Verbindungshaken · Opzione · Option · Option · Opzion



Sistema di aggancio tra elementi
Components connector
Systeme d'assemblage de socle
Verbindungssystem zwischen Elemente



Su richiesta attacco per connessione elettrica e USB con sovrapprezzo
Electrical connection and USB upon request with upcharge
Sur demande connection électrique et USB avec surcoût
Elektrische Verbindung und USB- Anschluss auf Anfrage gegen Aufpreis

Rivestimenti consigliati · Recommended coverings · Revêtements conseillées · Empfohlene Bezüge

• cat. A	XTREME	• cat. C	TREND	• cat. extra	MOLLY	• cat. lux	LUX 1
• cat. A	STEP	• cat. C	SUPERB	• cat. extra	RIME	• cat. lux	LUX 2
• cat. A	ANGEL	• cat. C	HESTAN	• cat. extra	STEELCUT TRIO 3	• cat. imperial	IMPERIAL 1
• cat. A	MEDLEY	• cat. C	DEANS	• cat. extra	COLLINE	• cat. imperial	IMPERIAL 2
• cat. A	MOOD	• cat. super	REMIX 3	• cat. extra	OPERA	• cat. imperial	NABUK
• cat. A	CRAZY	• cat. super	CAPTURE	• cat. extra	DANTE	• cat. special	DROP
• cat. B	EXTREMA	• cat. super	MODA	• cat. extra	ARCO		
• cat. B	IKON	• cat. super	REVIVE 1	• cat. maxi	HALLINGDAL 65		
• cat. B	SILVERTEX	• cat. super	BREEZE FUSION	• cat. maxi	COMFORT		
• cat. B	SAMAR			• cat. maxi	DIVINA 3		
• cat. B	FAME						
• cat. B	MAIN LINE FLAX						

WHY NOT

cod. 8451 / **3 seater**

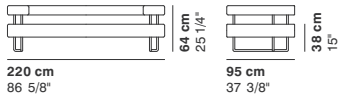

cod. 8452 / **4 seater**

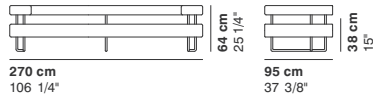

cod. 8469 / **element 100**

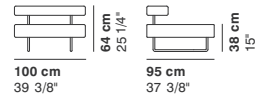

cod. 8470 / **element 140**

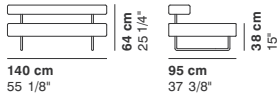

cod. 8453 / **element 190**

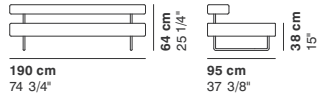

cod. 8454 dx / **right half back element 190**

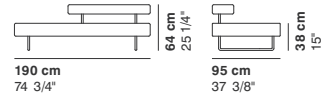

cod. 8455 sx / **left half back element 190**



cod. 8456 sx / **left element 190**

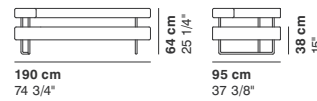

cod. 8457 dx / **right element 190**

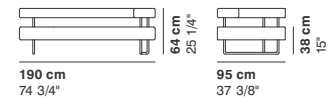

cod. 8458 / **closed corner R 180**

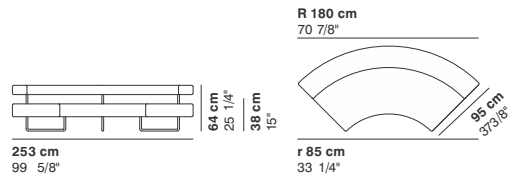

cod. 8459 / **open corner R 180**

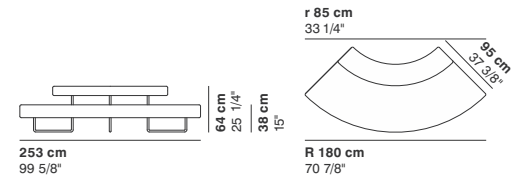

cod. 8460 / **closed element R 395**

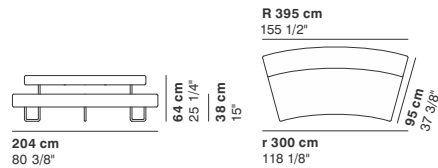

cod. 8461 / **open element R 395**

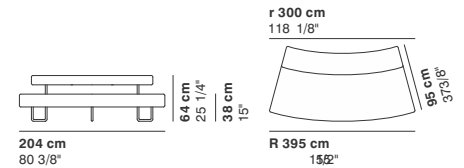

cod. 8464 dx / **open element right half back R 395**

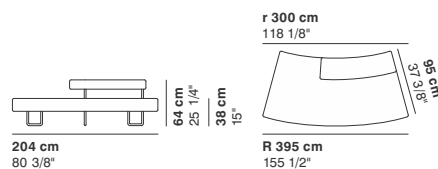

cod. 8465 sx / **open element left half back R 395**

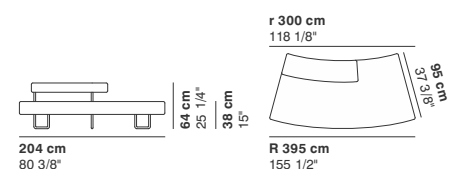

WHY NOT

cod. 8463 dx / closed element right half back R 395

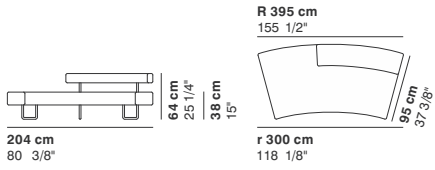

cod. 8462 sx / closed element left half back R 395

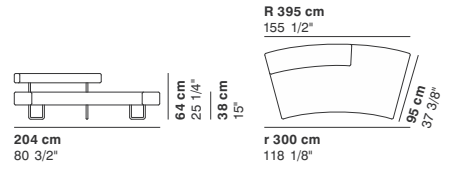

cod. 8466 / bench 190

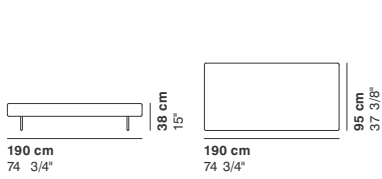

cod. 8467 / bench R 180

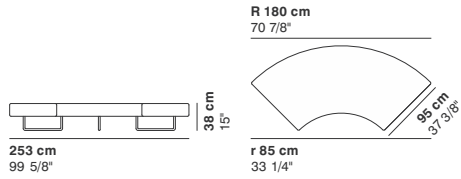

cod. 8468 / bench R 395

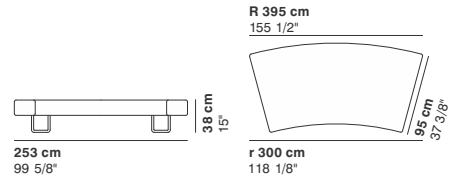

WHY NOT

cod. WHY01 / composition

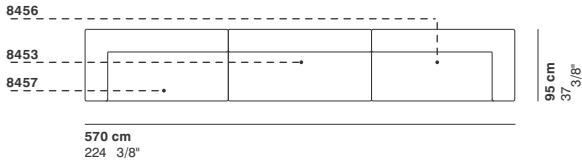

cod. WHY02 / composition

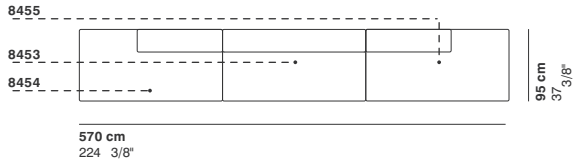

cod. WHY03 / composition

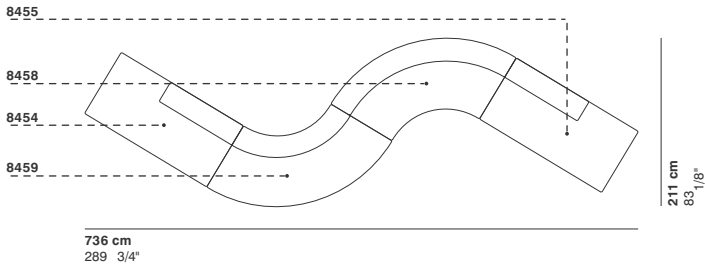

cod. WHY04 / composition

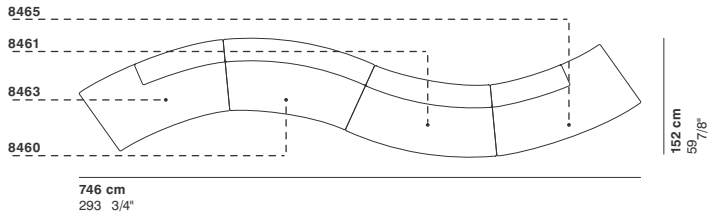

cod. WHY05 / composition

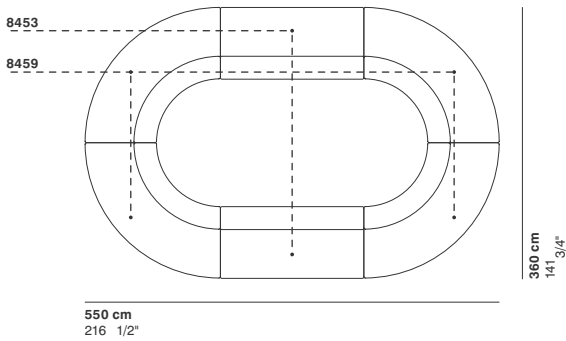

cod. WHY06 / composition

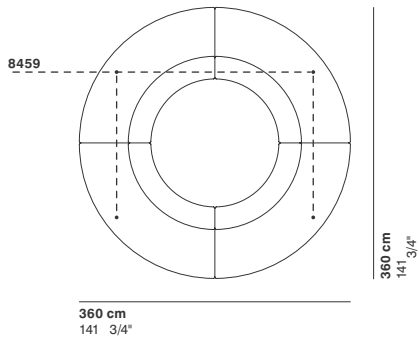

cod. WHY07 / composition

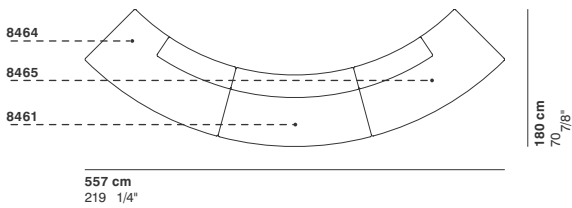

cod. WHY08 / composition

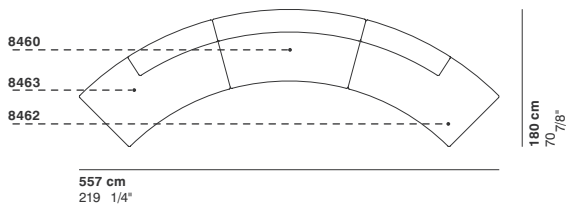

La Cividina s.r.l., al fine di migliorare caratteristiche tecniche e qualitative della sua produzione, si riserva di apportare, anche senza preavviso, tutte le modifiche che si rendessero necessarie.

With a view to improving the technical characteristics and quality of its products, La Cividina s.r.l. reserves the right to develop its products at anytime without notice.

Afin d'améliorer les caractéristiques techniques et qualitatives de sa production, La Cividina s.r.l. se réserve d'apporter, même sans préavis, toutes les modifications qui se rendront nécessaires.

Zur Verbesserung der technischen und qualitativen Merkmale, behält sich La Cividina s.r.l. vor, alle notwendig erscheinenden Produktionsänderungen, auch ohne Vorankündigung durchzuführen.



ISO 9001

LaCividina srl

**HEADQUARTERS
/ PRODUCTION**

Via Cividina 176
33035 Martignacco
Udine Italy

SHOWROOM

Via Lungolavia 1
33035 Martignacco
Udine Italy

T. + 39 0432 677433

F. + 39 0432 677480

info@lacividina.com

www.lacividina.com

VAT nr. IT01810870301