

ADD 

Francesco Rota | 2014





Francesco Rota | 2014

Nature is a system of endless scenarios. It grows in spring, rests in winter, starts germinating again and arranges and re-arranges the line on the horizon every time. The ADD seating system, an international success, follows the same rhythms and, with the same versatility, also accompanies the pleasure of spending time together outdoors. The primary element, the seed that gives life to everything, is an elegant chair with aluminium base supports, which can be added to in order to become a modular sofa with removable covers. Woods, cornfields, the perspectives of modern architecture spring to mind. An endless ensemble.





Classic mini



Two seater



Three seater



Vis-à-vis — small

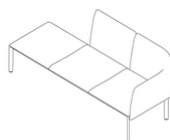

Classic



Classic mini — double

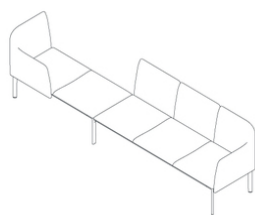

Vis-à-vis — big



Side by side

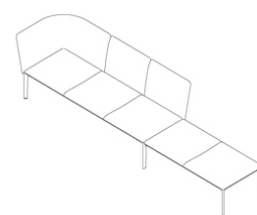

Open

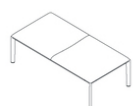

Bench two seater

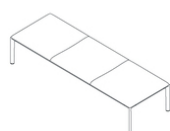

Bench three seater

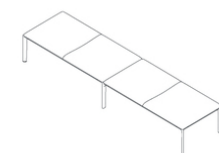

Bench four seater

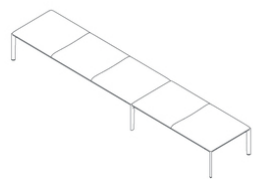

Bench five seater

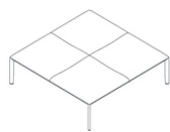

Square bench

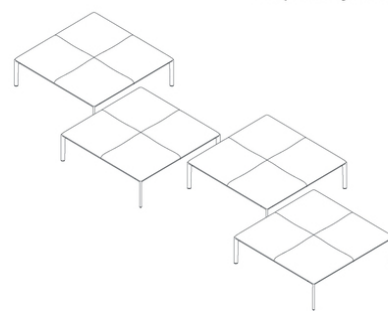

Square bench system



L_shape - 1



L_shape - 2

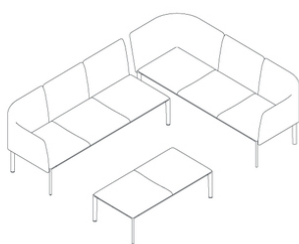

L_shape - 3

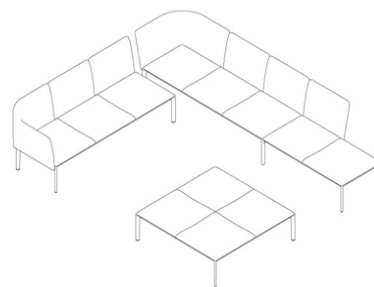

L_shape - 4

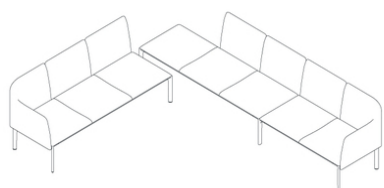

L_shape - 5

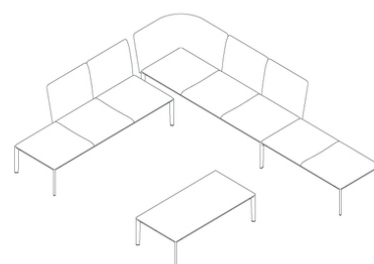

L_shape - 6

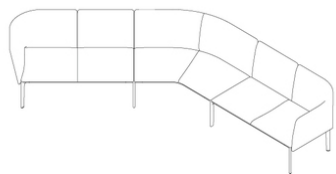

V_shape in

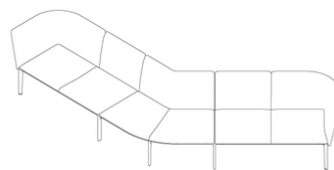

V_shape out

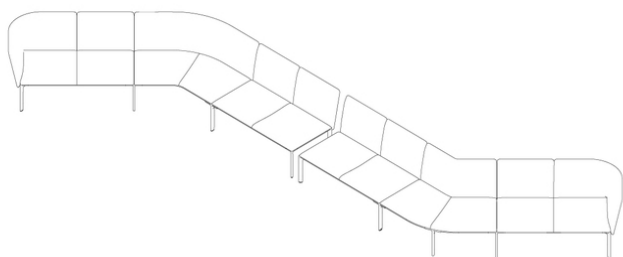

S_shape - 1

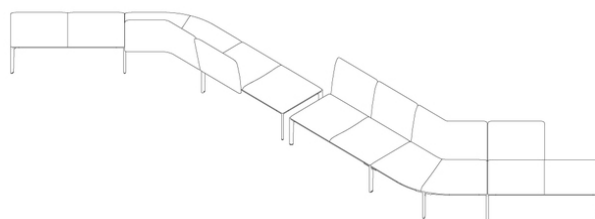

S_shape - 2

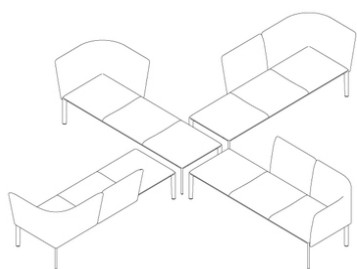

X_shape

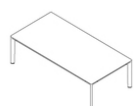

Two

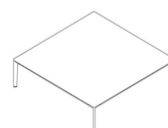

Four

Francesco Rota | 2014

Modular seating system with aluminium frame polyester powder coated with webbed elastic support. Two types of recycled die-cast aluminium legs, one for corners and another to connect frames for larger configurations. Each leg type is available in two heights. Backrests can be fixed to the frame in several positions by using pre-drilled holes. Cushions and backrests in moulded fire-retardant polyurethane foam with protective water-resistant and breathable fabric layer and finished with UV stable outdoor fabric. Tops in HPL Fenix® 10 mm. All metal parts are powder coated. Water-resistant protective covers are available.

TEST EN 1728:2012 AC:2013 6.17 - EN 16139:2013 - L2 extreme

legs



seat frames

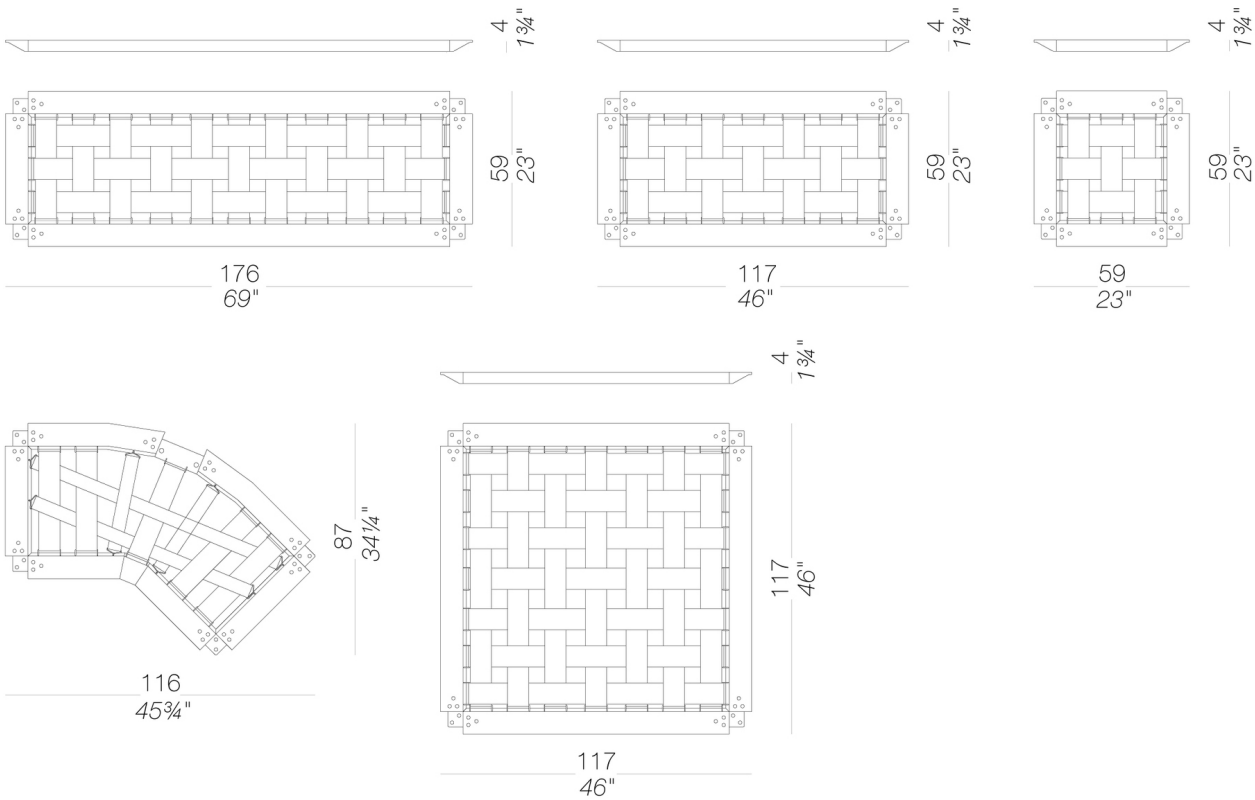

ADD

Francesco Rota | 2014

cushions

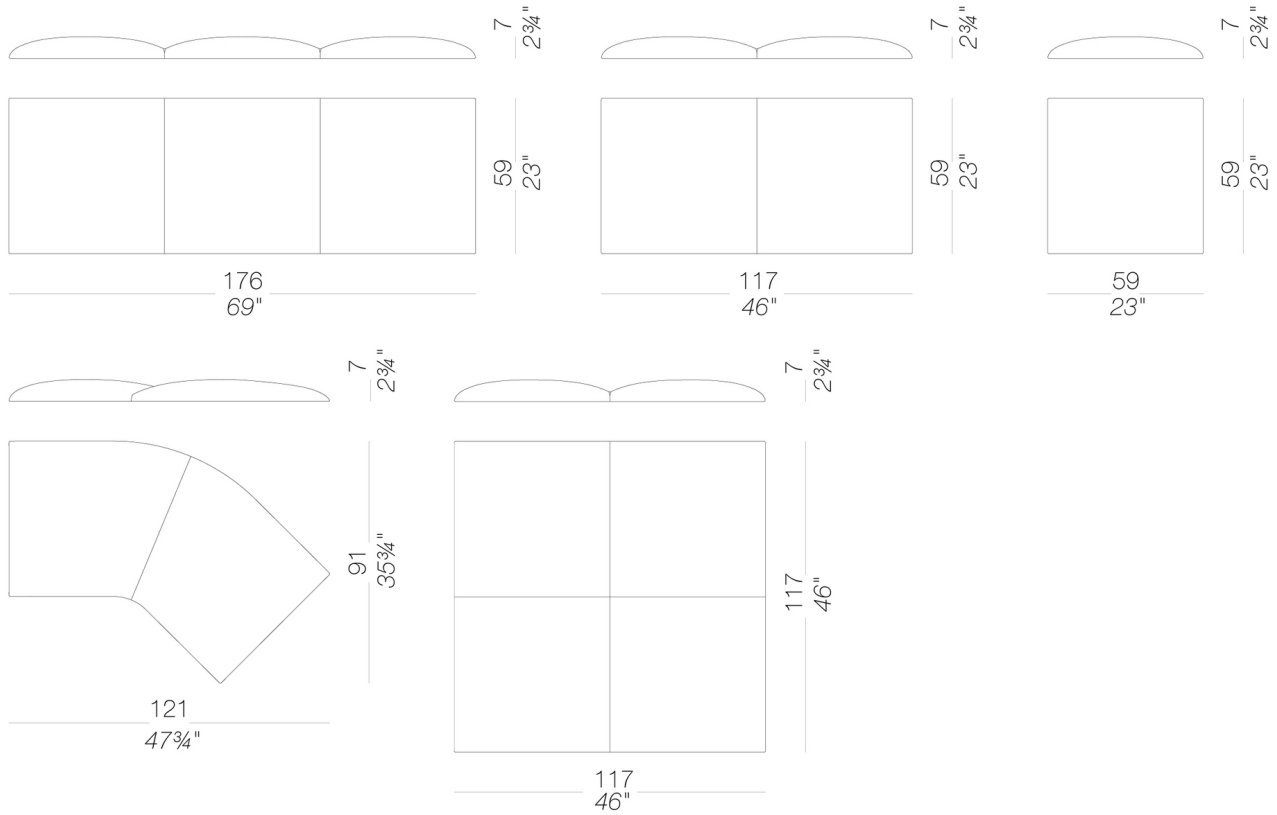

backs

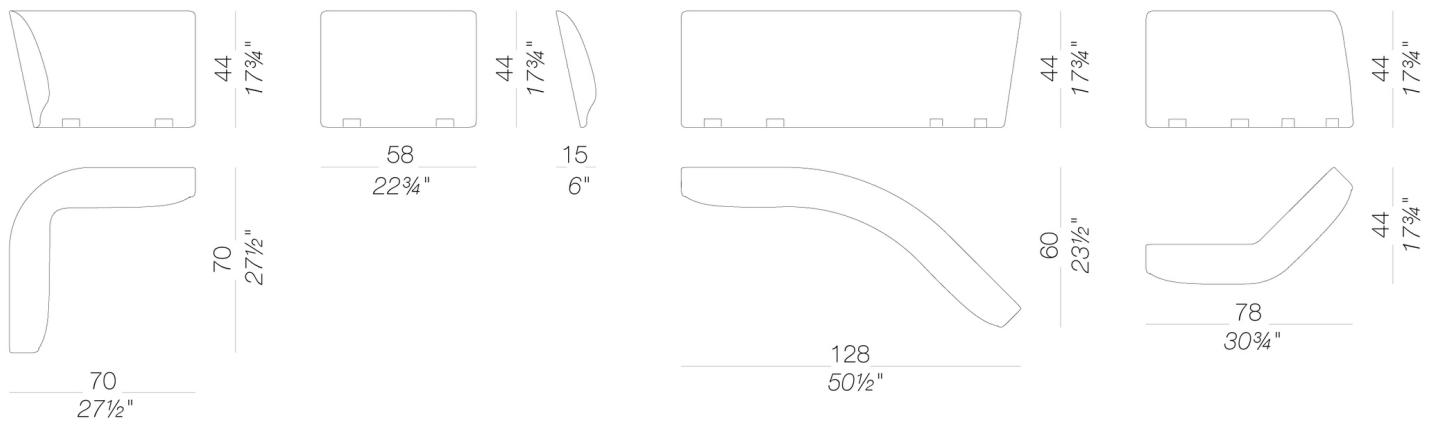

ADD

Francesco Rota | 2014

table frames

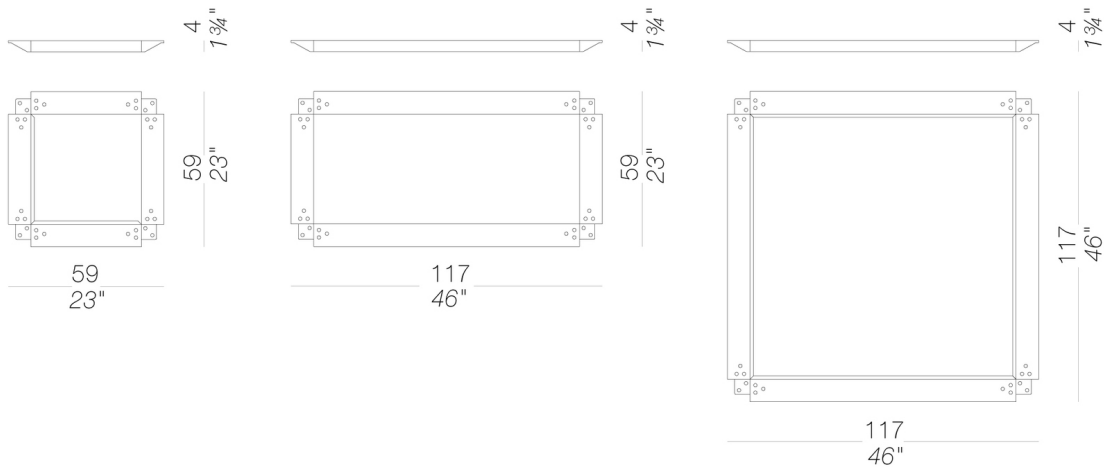
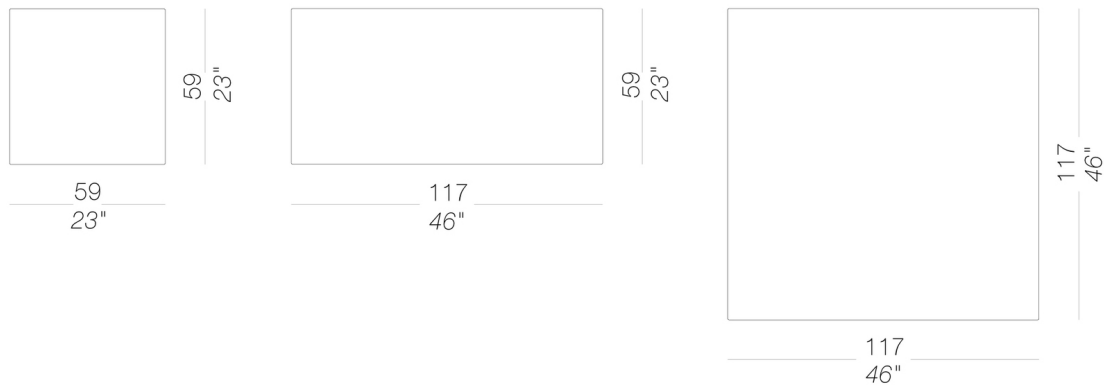
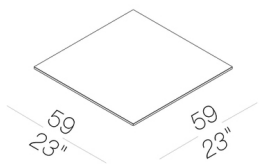

table tops



low tables



frame



powder coating
black
1 Colors

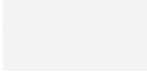

powder coating
white
1 Colors

top



HPL 10 mm
black HPL fenix
1 Colors

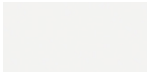

HPL 10 mm
white HPL fenix
1 Colors

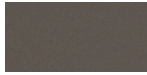

HPL 10 mm
HPL fenix grigio
Londra
1 Colors



HPL 10 mm
HPL fenix rosso
Jaipur
1 Colors

upholstery

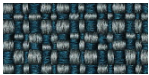

fabric
Iris - Grade B
24 Colors



fabric
Lapalma Smart -
Grade C
18 Colors



fabric
Nattè - Grade B
30 Colors

consult the folder of materials for the range of colors and fabrics

use and maintenance instructions

Plastic materials, even if intended for outdoor use, may still be attacked over time by particular atmospheric pollutants (e.g. acid rain, high concentration of PM10, nitrogen oxides, hydrocarbons, etc.). Any changes in the surface and in colours may therefore occur under particular conditions of exposure and cannot be considered grounds for any claims.

Do not use detergents containing bleach, hydrochloric acid or products containing chloride on any metal parts. Salt, limescale or acid (from coffee, wine, orange juice, tomato juice, lemon, etc.) may discolour stainless steel parts if they are not promptly cleaned. Products or parts made of stainless steel used near the sea or in interior fittings of swimming pools require more frequent cleaning to remove chloride deposits and prevent corrosion and chemical attack of the external surface. Stains on stainless steel surfaces must be promptly cleaned. If left for a long time they can become permanent.

Outdoor fabrics are lined unglued, therefore any creasing in the upholstery is an inevitable consequence of use and cannot be considered grounds for any claims. To prolong the life of the product, clean the surfaces regularly, dry them with a clean cloth and remove any stagnant water, especially if exposed in locations with a high level of humidity or a marine climate.

When not in use, we recommend storing in sheltered places and covering with waterproof protection. In this case, it is advisable to remove the cover and ventilate the product frequently and regularly to avoid the onset of any mould or stains due to damp.

THE WARRANTY WILL NOT COVER DEFECTS OR IMPERFECTIONS RESULTING FROM THE PASSAGE OF TIME OR TO WEAR AND TEAR DUE TO THE NORMAL USE OF THE PRODUCT.

ADD SOFT

Francesco Rota | 2018





Francesco Rota | 2018

Nature loves softness, in all seasons. Dunes, sea waves and sparkling snow in the early morning sunlight. The ADD SOFT seating system, with an aluminium frame and elastic straps that ensure support and gentle relaxation, has been inspired by this delightful softness. It has deep and generous cushions, an embracing profile and offers infinite combinations. Like landscapes, a garden, a terrace, the outdoor space of a restaurant, even an outside area of an office. You can sit down, relax, work and imagine yourself on a surfboard.





Coffee table

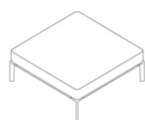

Pouf

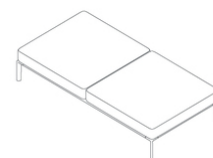

Pouf double

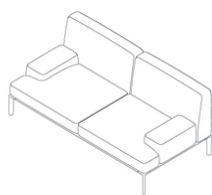

Two seater - low

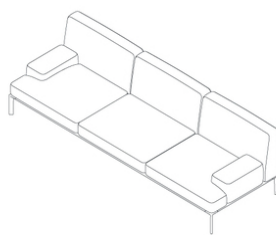

Three seater - low

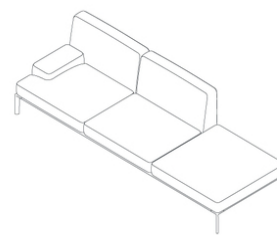

Three seater - low open - 1

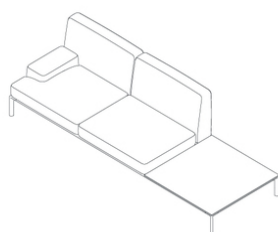

Three seater - low + table

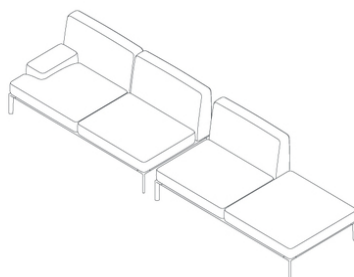

Four seater - low open - 1

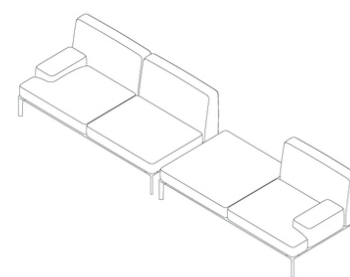

Four seater - low open - 2

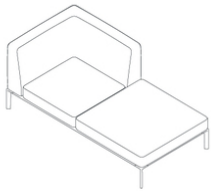

Two seater – high open - 1

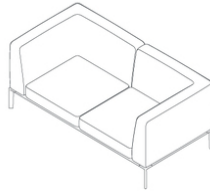

Two seater – high

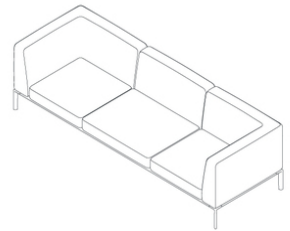

Three seater – high

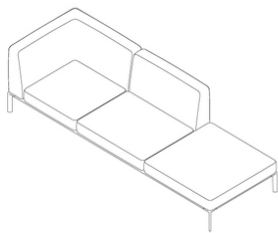

Three seater – high open - 1

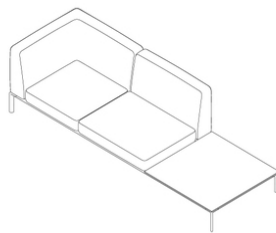

Three seater – high + table

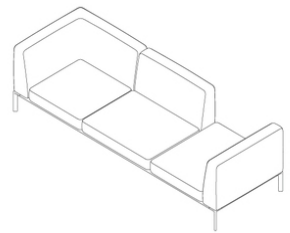

Three seater – high vis-à-vis

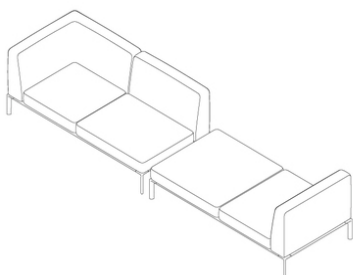

Four seater – high vis-à-vis

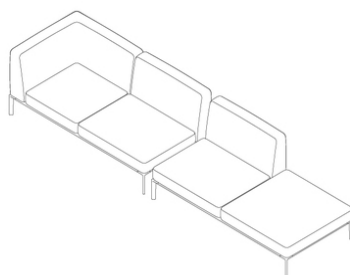

Four seater – high open - 1

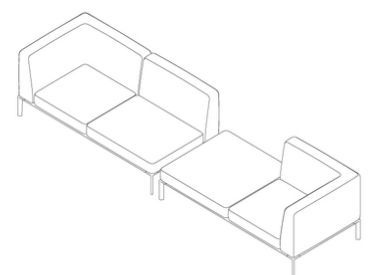

Four seater – high open - 2

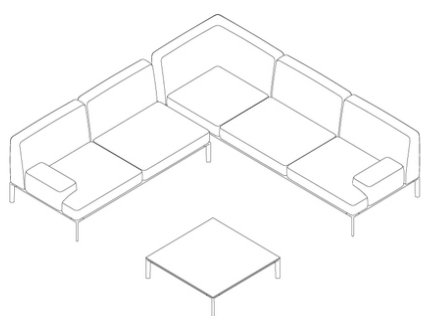

L_shape — low - 1

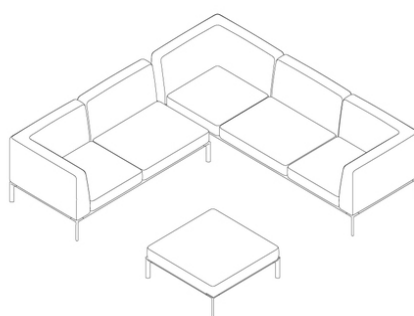

L_shape — high - 1

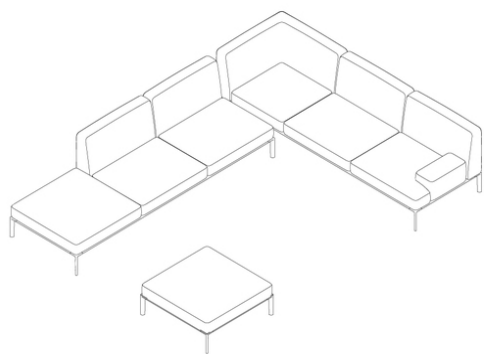

L_shape — low open - 1

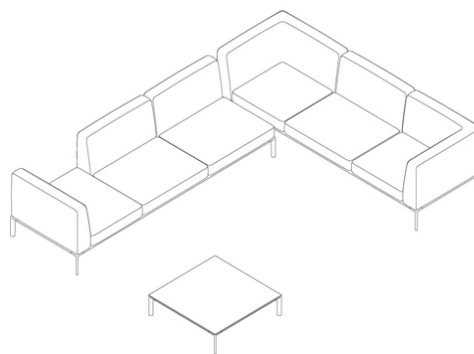

L_shape — high open - 1

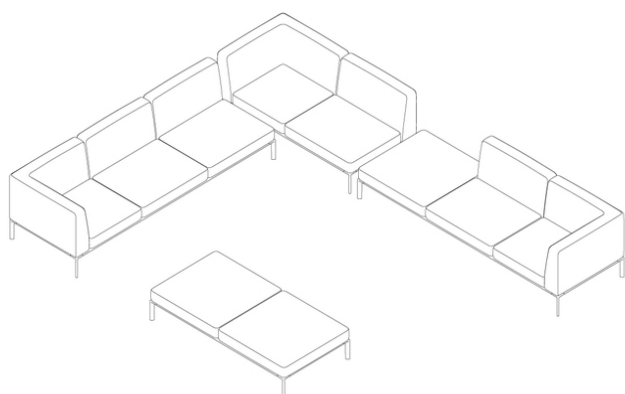

L_shape — low open - 2

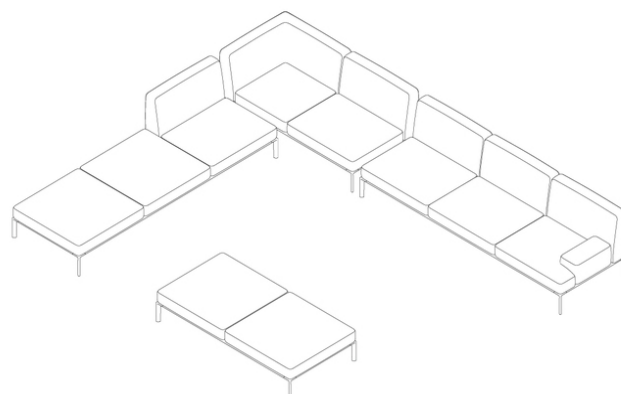

L_shape — high open - 2

ADD SOFT

Francesco Rota | 2018

Modular seating system with aluminium frame polyester powder coated and webbed elastic support. Legs in recycled die-cast aluminium. Back- and armrests can be fixed to the frame in several positions by using pre-drilled holes. Cushions and backrest in polyurethane foam with variation in density and polyester fiber, all fire-retardant, with protective water-resistant and breathable fabric layer and finished with UV stable outdoor fabric. ADD is complemented by tops in HPL Fenix® 10 mm. All metal parts are powder coated. Water-resistant protective covers are available.

legs



seat frames

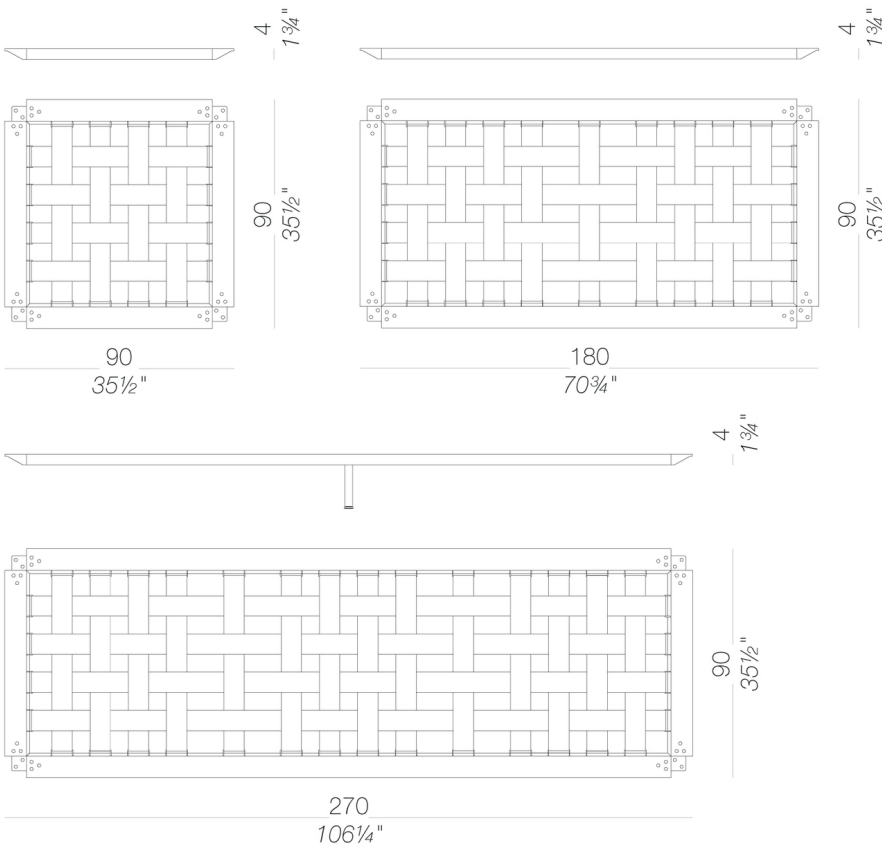

ADD SOFT

Francesco Rota | 2018

cushions

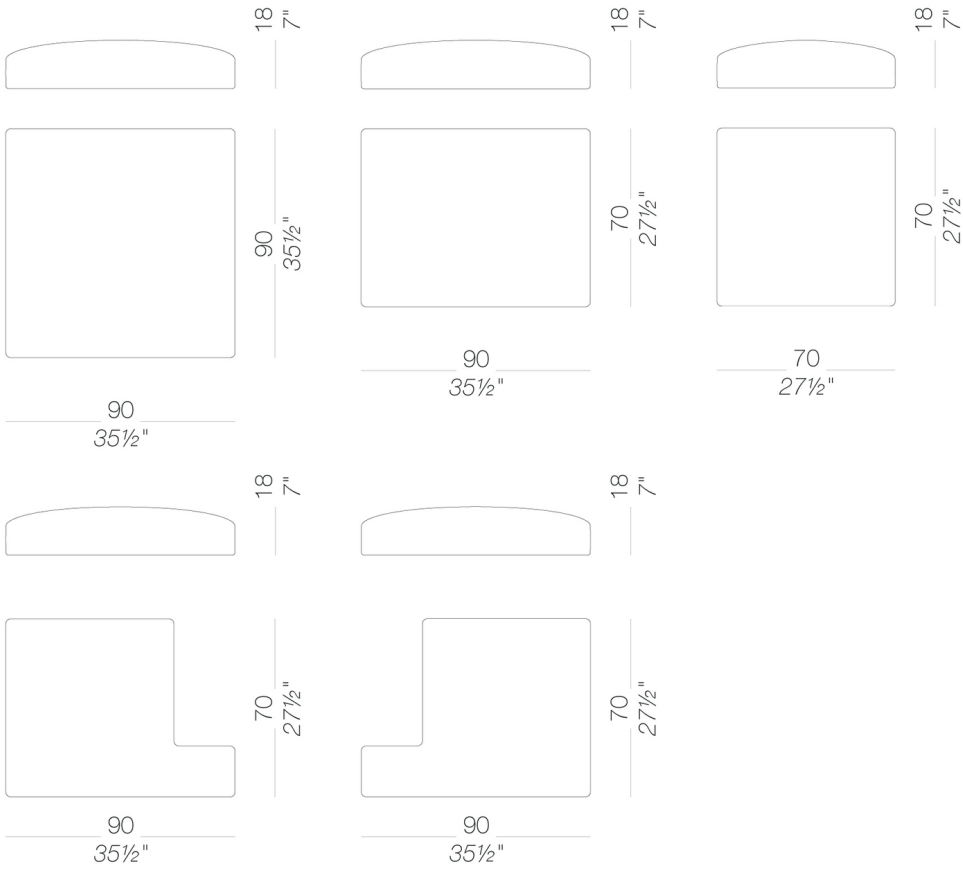

backs

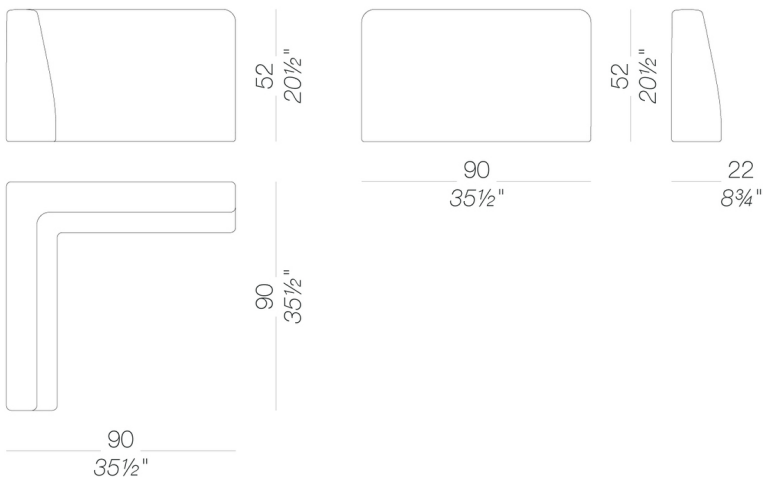

ADD SOFT

Francesco Rota | 2018

armrest

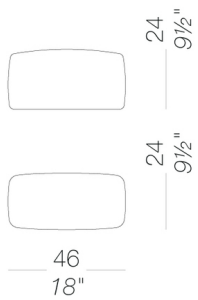
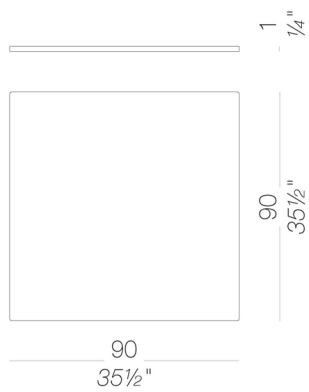

table top



ADD SOFT

Francesco Rota | 2018

frame



powder coating
black
1 Colors

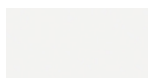

powder coating
white
1 Colors

top



HPL 10 mm
black HPL fenix
1 Colors

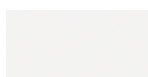

HPL 10 mm
white HPL fenix
1 Colors

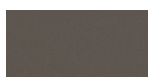

HPL 10 mm
HPL fenix grigio
Londra
1 Colors

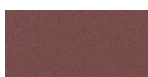

HPL 10 mm
HPL fenix rosso
Jaipur
1 Colors

upholstery

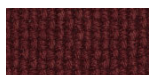

fabric
Lapalma Smart -
Grade C
18 Colors

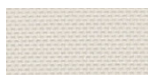

fabric
Nattè - Grade B
30 Colors



fabric
Ilris - Grade B
24 Colors

consult the folder of materials for the range of colors and fabrics

use and maintenance instructions

Plastic materials, even if intended for outdoor use, may still be attacked over time by particular atmospheric pollutants (e.g. acid rain, high concentration of PM10, nitrogen oxides, hydrocarbons, etc.). Any changes in the surface and in colours may therefore occur under particular conditions of exposure and cannot be considered grounds for any claims.

Do not use detergents containing bleach, hydrochloric acid or products containing chloride on any metal parts. Salt, limescale or acid (from coffee, wine, orange juice, tomato juice, lemon, etc.) may discolour stainless steel parts if they are not promptly cleaned. Products or parts made of stainless steel used near the sea or in interior fittings of swimming pools require more frequent cleaning to remove chloride deposits and prevent corrosion and chemical attack of the external surface. Stains on stainless steel surfaces must be promptly cleaned. If left for a long time they can become permanent.

Outdoor fabrics are lined unglued, therefore any creasing in the upholstery is an inevitable consequence of use and cannot be considered grounds for any claims. To prolong the life of the product, clean the surfaces regularly, dry them with a clean cloth and remove any stagnant water, especially if exposed in locations with a high level of humidity or a marine climate.

When not in use, we recommend storing in sheltered places and covering with waterproof protection. In this case, it is advisable to remove the cover and ventilate the product frequently and regularly to avoid the onset of any mould or stains due to damp.

THE WARRANTY WILL NOT COVER DEFECTS OR IMPERFECTIONS RESULTING FROM THE PASSAGE OF TIME OR TO WEAR AND TEAR DUE TO THE NORMAL USE OF THE PRODUCT.

ADD SOFT

Francesco Rota | 2018



ADD SOFT

Francesco Rota | 2018

Softness is possible. And you can imagine an office that accommodates wide and spacious seating. Time for meetings or simply more time, as at home. In the name of relaxation, the ADD SOFT seating system adds depth and opens up to the most successful art of combinations. With its embracing dimensions, the legs of the frame are reduced in height to make space for comfortable cushions. The tabletops with electric sockets complement the functionality of the sofa. And it is a pity to get up from it.





Coffee Table



Pouf

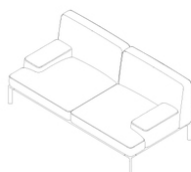

Two seater — low

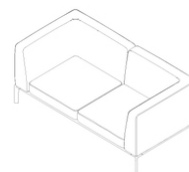

Two seater — high

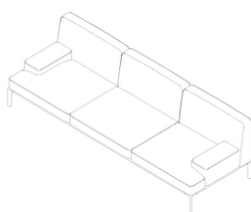

Three seater — low

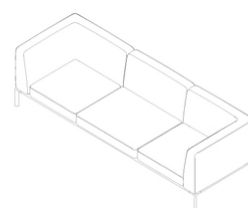

Three seater — high

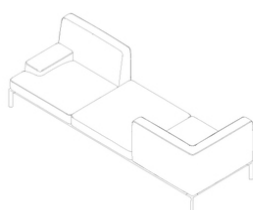

Vis-à-vis

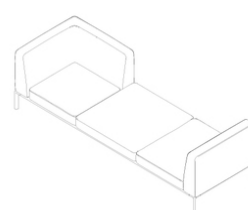

Vis-à-vis - 2

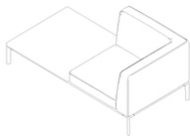

One seater high + table

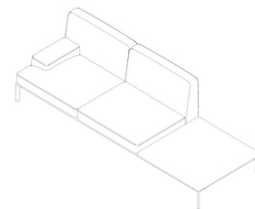

Two seater low + table

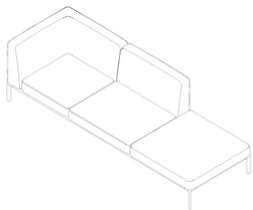

Three seater high — open

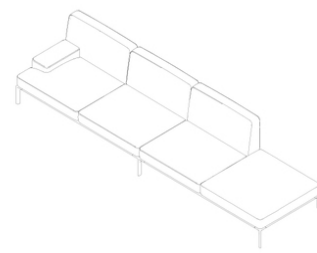

Side by side — open

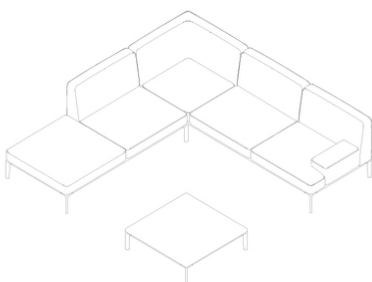

L_shape small — open

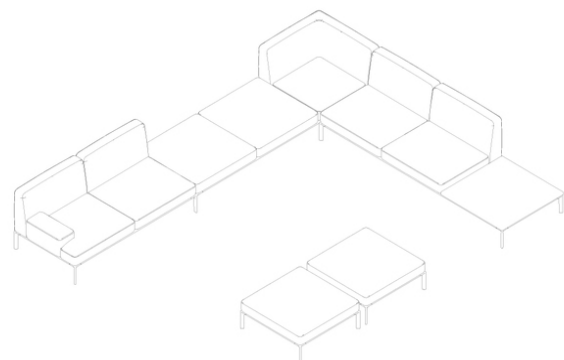

L_shape big — open

ADD SOFT

Francesco Rota | 2018

Modular seating system with powder coated aluminium frame and webbed elastic support. Two types of legs in recycled die-cast aluminium, one for the corners and another to connect frames for larger configurations. Backrests and accessories can be fixed to the frame in several positions by using existing holes. Cushions and backrest in polyurethane foam with variation in density and polyester fiber, all fire-retardant, upholstered with removable fabric, soft leather or eco-leather. ADD is complemented by tops in various finishes, also with sockets. All metal parts are powder coated

legs



seat frames

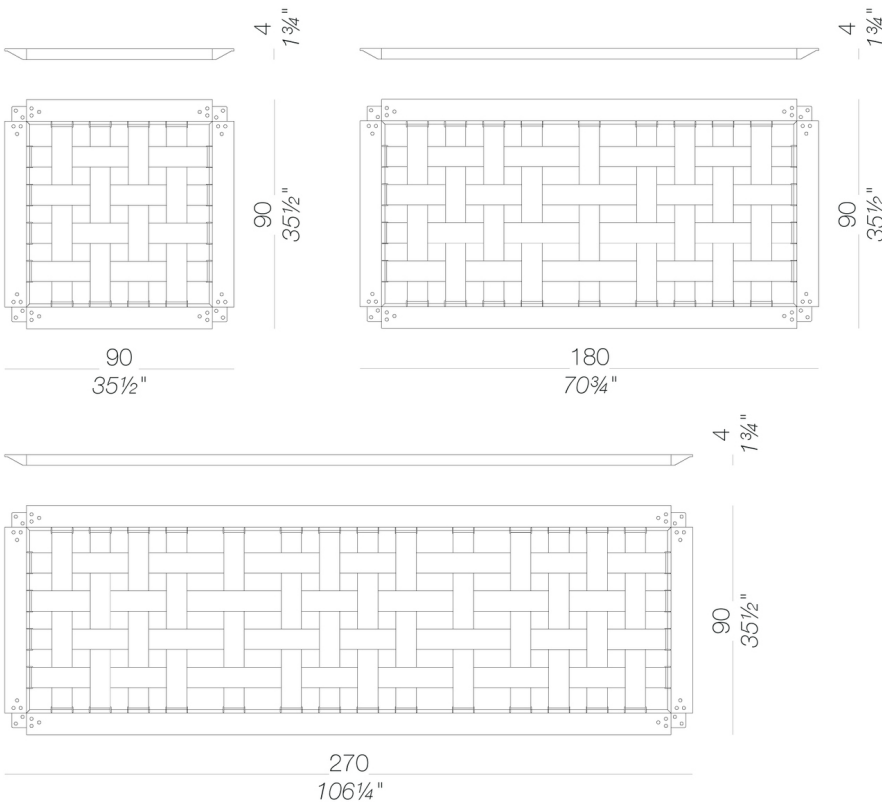
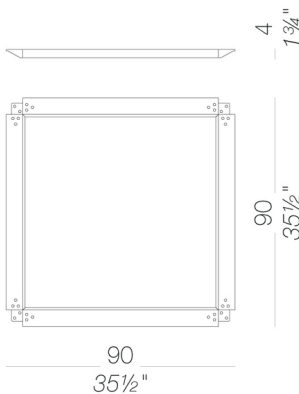

table frames



ADD SOFT

Francesco Rota | 2018

cushions

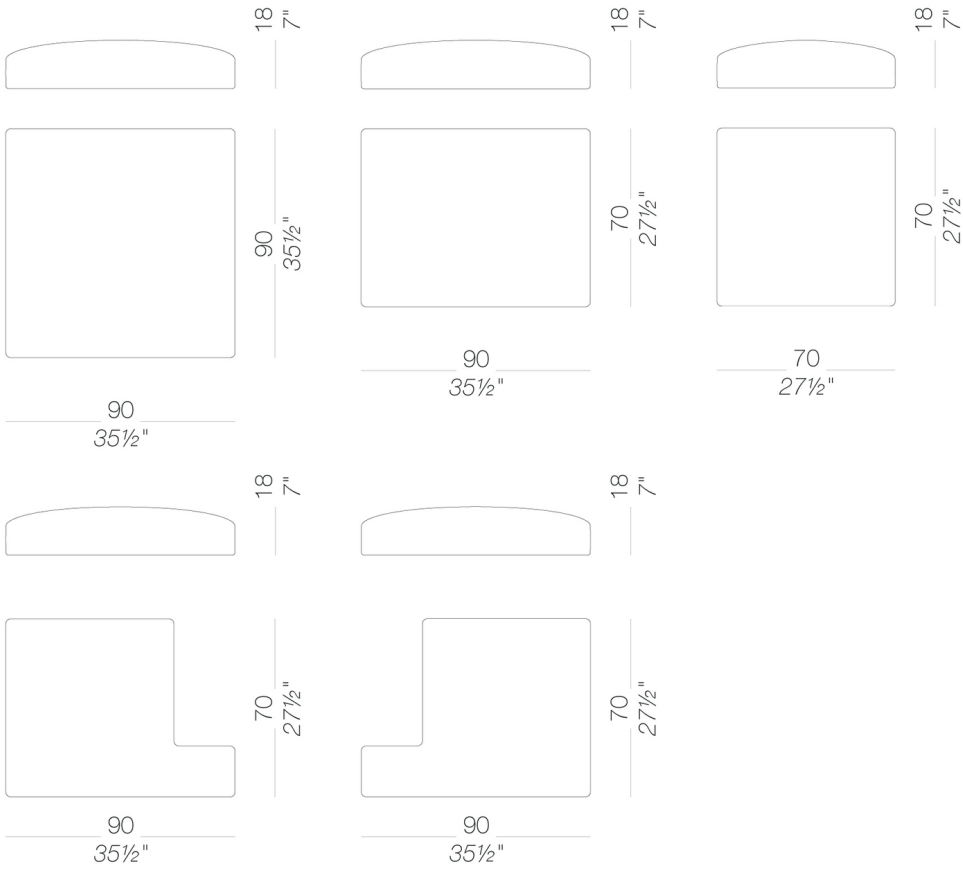

backs

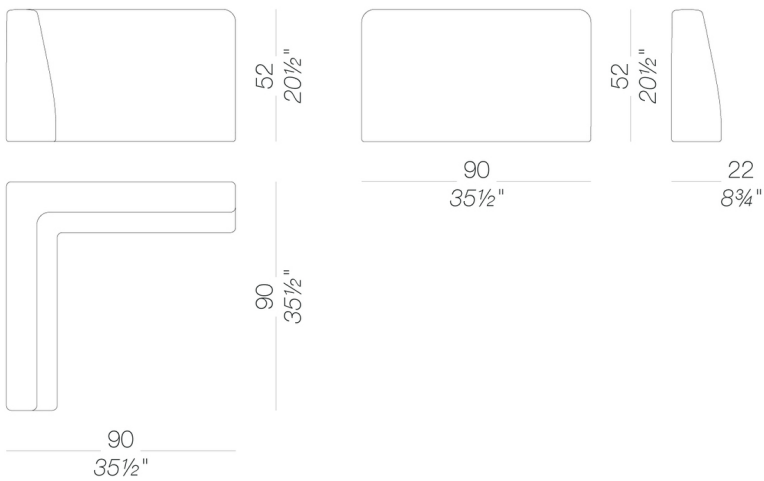

ADD SOFT

Francesco Rota | 2018

armrest

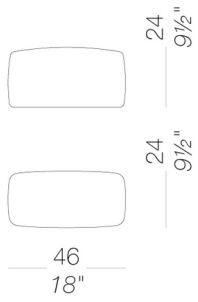
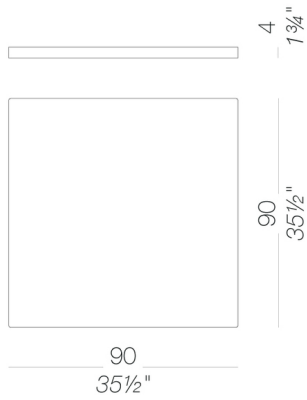

table top



ADD SOFT

Francesco Rota | 2018

frame



powder coating
black
1 Colors

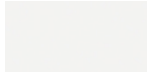

powder coating
white
1 Colors

upholstery

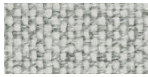

fabric
Hallingdal 65 -
Grade C
58 Colors



fabric
Canvas 2 - Grade C
45 Colors



fabric
Steelcut Trio 3 -
Grade D
54 Colors



fabric
Remix 3 - Grade C
72 Colors

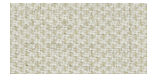

fabric
Clara 2 - Grade C
24 Colors



fabric
Divina MD - Grade
27 Colors



fabric
DFiord 2 - Grade C
39 Colors



fabric
Divina Melange 3 -
Grade D
38 Colors

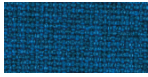

fabric
Medley - Grade A
37 Colors



fabric
Tonica 2 - Grade C
39 Colors

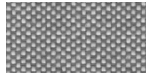

fabric
Maya - Grade A
43 Colors



fabric
Jet - Grade A
66 Colors



fabric
Lapalma Smart -
Grade C
18 Colors

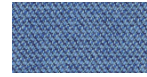

fabric
Capture - Grade B
43 Colors



fabric
Crisp - Grade B
40 Colors



fabric
Iris - Grade B
24 Colors



fabric
Nattè - Grade B
30 Colors



fabric
Steelcut 3 - Grade D
40 Colors

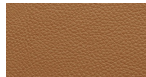

soft-leather
Pelle Seta
18 Colors



ecoleather
GRIMM FR - Grade
A
32 Colors



ecoleather
Valencia - Grade B
66 Colors

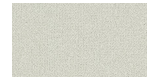

fabric
Grain - Grade. B
50 Colors

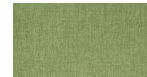

fabric
Fortezza 68 - Grade
B
53 Colors



fabric
Re-wool - Grade C
21 Colors

top



wood
blanché oak
1 Colors

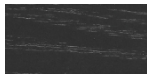

wood
black open pore
1 Colors



laminate
fenix 9/10
2 Colors

consult the portfolio for the range of colors, fabrics, eco-leather, soft-leather.

use and maintenance instructions

Clean all parts in wood, leather, fabric and metal with a damp cloth or a diluted neutral cleaner. Do not use cleaners with alcohol, bleach, solvent or abrasive products. Any liquid spilt on the product must be wiped up immediately. When lifting or moving the product, hold it on the structure and not under the seat. The product should not be subjected to unbalanced weights, as it is designed for a proper rest on the foothold (on four legs or on the base). Our company relieves from any responsibility in case of damage caused to fragile floors. Avoid any improper use of the product: do not step on the product, on the footrest or on the armrests. Avoid any movements that could compromise the proper functionality of the product or the safety of the users. Wood and leather, being natural materials, could be easily damaged. Small impurities or imperfections are within quality standard range. Do not expose the product to weather conditions or atmospheric agents, nor to heat sources over 40°C. Also products for outdoor use could be afflicted by atmospheric agents. The product could undergo possible exterior changes due to particular exposure to heat, humidity and saltiness. An appropriate and frequent maintenance and cleaning of the product enhances its durability. The product could change colour and shade, if exposed to direct sunlight. Maintenance has to be carried out by experienced staff. Dispose of the package only after assembling the product, in order to avoid the loss of ironmongery and components. Once the product has been dismantled, the product itself or its components must be given to the public garbage disposal system, according to the legislation in force.