

# Luca

# SITS



# Luca

## UPHOLSTERY



fabric



\*\*  
leather  
only in FC

## COMFORTS



STD standard



CLS classic



LUX lux



PLUS plus

## COVERS



FC fixed



LCV loose with velcro

## SPECIAL



modular  
system

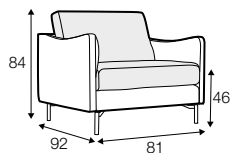

armchair

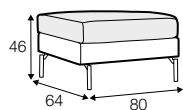

footstool 80x64

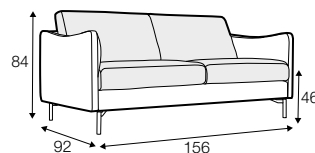

2 seater

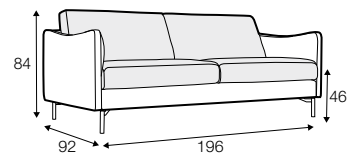

2,5 seater

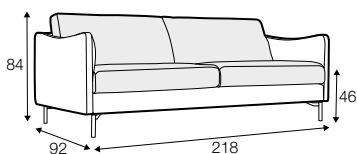

3 seater

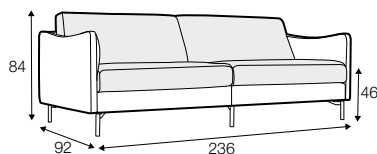

4 seater divided

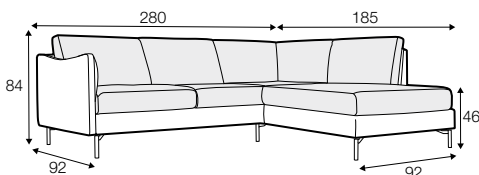

set 4 right / or left

2,5 seater left / or right + divan right / or left

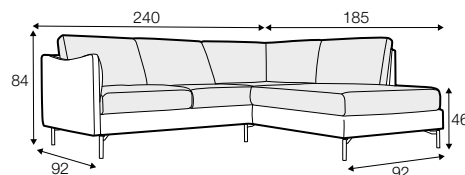

set 5 right / or left

2 seater left / or right + divan right / or left

## modular system

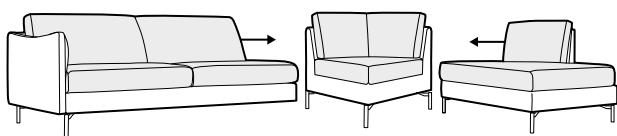

## elements of the modular system

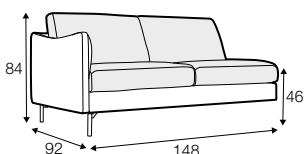

2 seater  
left / or right

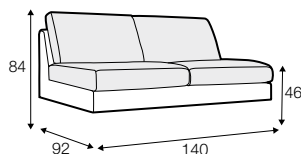

2 seater  
without armrests

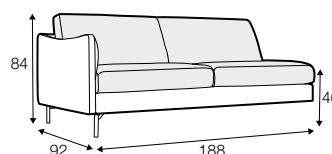

2,5 seater  
left / or right

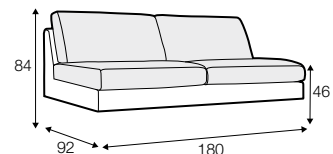

2,5 seater  
without armrests

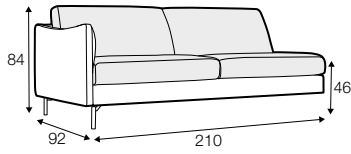

3 seater left / or right

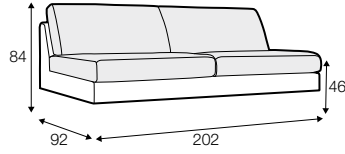

3 seater without armrests

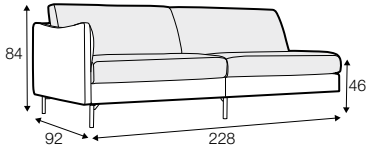

4 seater left / or right divided

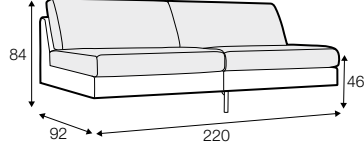

4 seater without armrests divided

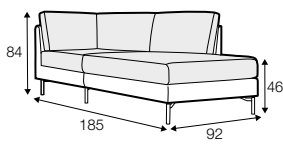

divan right / or left

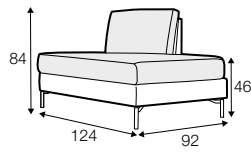

bench right / or left

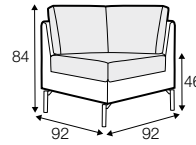

corner 90°

### extra dimensions

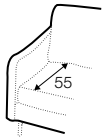

depth of seat

### accessories

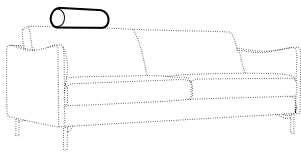

headrest with roll L-60

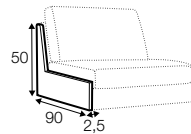
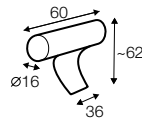

endpart left / or right

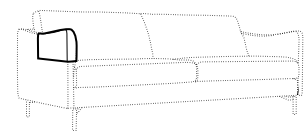

armrest protection



### legs

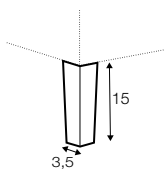

no. 109  
wood

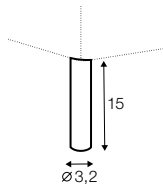

no. 195  
metal chrome,  
painted black

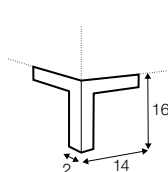

no. 47  
metal chrome,  
painted black

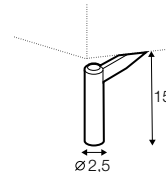

no. 145A  
metal chrome,  
painted black

## profile

---

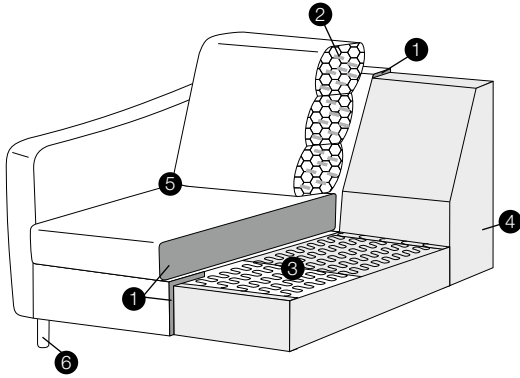

### standard

1. polyurethane foam / high resilient polyurethane foam
2. foam flakes with silicone balls
3. springs
4. solid wood and wood based elements
5. fabric
6. solid wood or metal legs

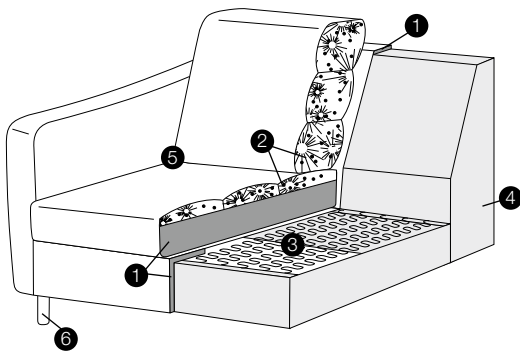

### lux

1. polyurethane foam/high resilient polyurethane foam
2. cushion chamber with mix of feather and silicone balls
3. springs
4. solid wood and wood based elements
5. fabric or leather
6. solid wood or metal legs

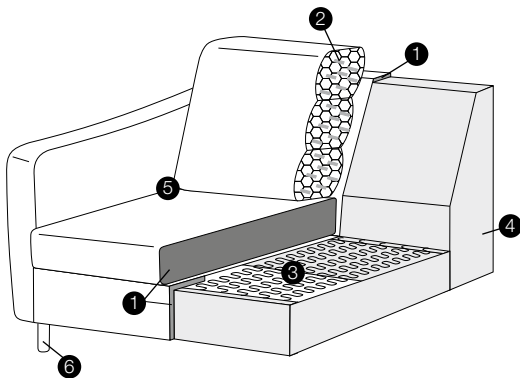

### classic

1. polyurethane foam/high resilient polyurethane foam
2. foam flakes with silicone balls
3. springs
4. solid wood and wood based elements
5. fabric or leather
6. solid wood or metal legs

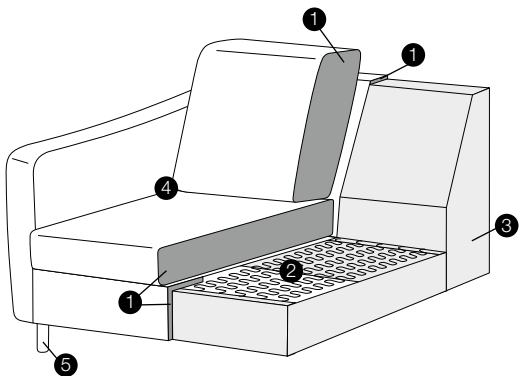

### plus

1. polyurethane foam/high resilient polyurethane foam
2. springs
3. solid wood and wood based elements
4. fabric or leather
5. solid wood or metal legs