

Ville

SITS



Ville

J. Archer

designed by: Ian Archer



UPHOLSTERY

COMFORTS

COVERS

SPECIAL



fabric



STD standard



FC fixed



modular system

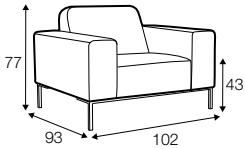

armchair

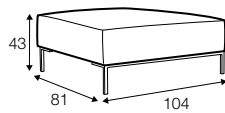

footstool 104x81

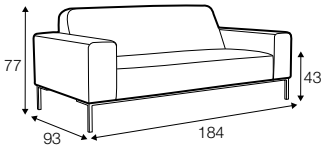

2 seater

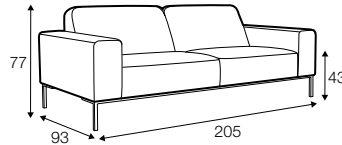

3 seater

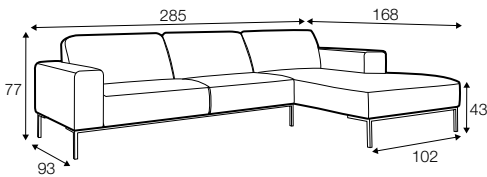

set 1 right / or left

3 seater left / or right + chaiselongue right / or left

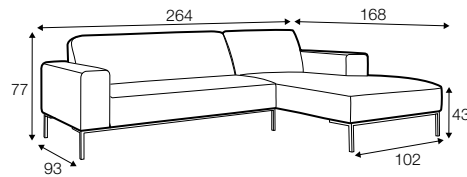

set 2 right / or left

2 seater left / or right + chaiselongue right / or left

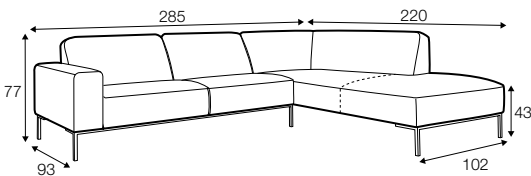

set 3 right / or left

3 seater left / or right + divan right / or left

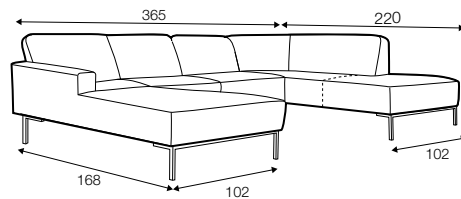

set 4 right / or left

chaiselongue left / or right + 3 seater without armrests + divan right / or left

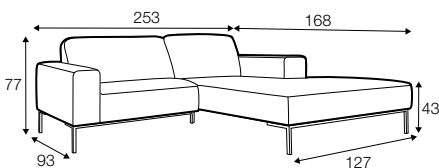

set 5 right / or left

armchair wide left / or right + chaiselongue wide right / or left

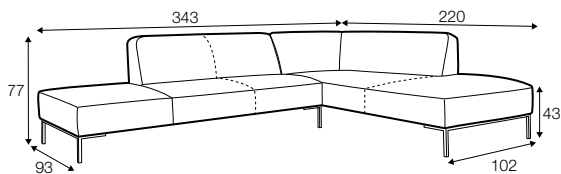

set 6 right / or left

bench left / or right + divan right / or left

modular system

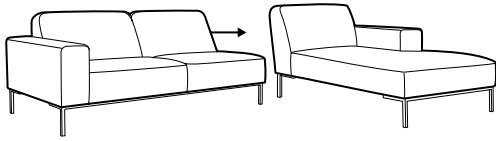

elements of the modular system

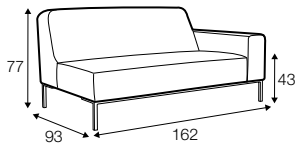

2 seater right / or left

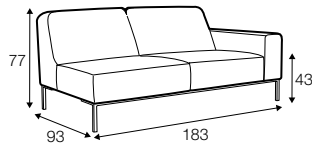

3 seater right / or left

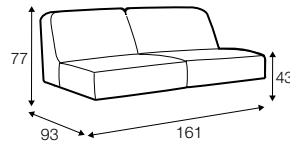

3 seater
without armrests

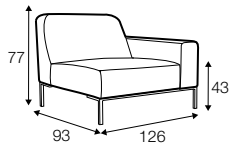

armchair wide
right / or left

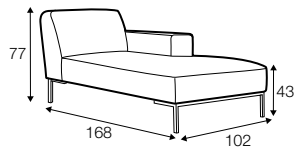

chaiselongue right / or left

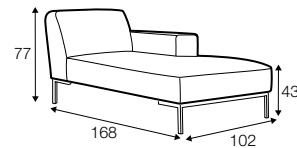

chaiselongue right / or left
freestanding

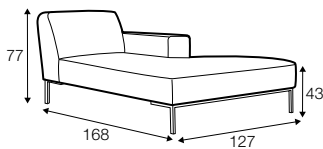

chaiselongue wide
right / or left

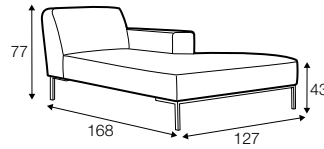

chaiselongue wide
right / or left freestanding

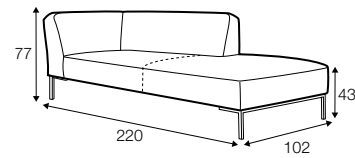

divan right / or left

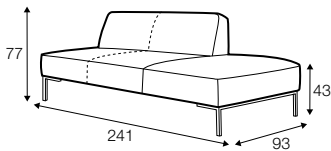

bench right / or left
Olny with leg no. 146 H-190

extra dimensions

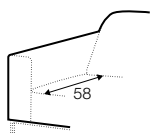

depth of seat

legs

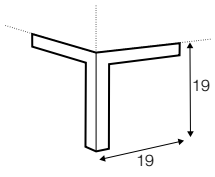

no. 146
metal chrome,
painted black
front and back

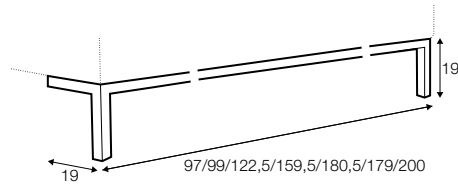

no. 146A
metal chrome,
painted black
only front

profile

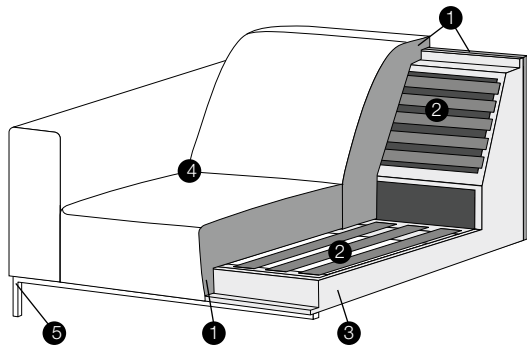

standard

1. polyurethane foam/ high resilient polyurethane foam
2. upholstery belts
3. solid wood and wood based elements
4. fabric
5. metal legs