

MAGIS



Baguette by Ronan & Erwan Bouroullec

Ronan & Erwan Bouroullec



Profile:

Ronan Bouroullec (born in 1971) and Erwan Bouroullec (born in 1976) have been working together for more than twenty years now. Their collaboration is a permanent dialogue, nourished by their distinct personalities and a shared notion of diligence, with the intention to achieve greater balance and refinement.

In 1997, they presented their Disintegrated Kitchen at the Salon du Meuble in Paris, where it was spotted by Giulio Cappellini, who gave them their first industrial design commissions. The Bouroullecs have been working with Magis since 2004, designing three complete furniture collections – Striped, Steelwood and Officina – as well as additional projects such as Pila chair, Pilo table, Central and Tambour tables. These days, Ronan and Erwan Bouroullec design for numerous manufacturers, including Magis, Vitra, Kvadrat, Kartell, Established and Sons, Ligne Roset, Axor, Alessi, Issey Miyake, Cappellini, Mattiazzi, Flos, Mutina,

Hay and more recently Glas Italia and Iittala. They also continue to carry out their own experimental activity which is essential to the development of their work at Galerie kreò, Paris, where four exhibitions of their designs were held between 2001 and 2012. They also embark on occasional architectural projects.

Voted Designers of the Year at the Salon du Meuble in 2002, their other awards include the Compasso d'Oro won in 2011 for the Steelwood chair they designed for Magis.

Several exhibitions have been devoted to their work.

In 2012, Phaidon Press published *Works*, a comprehensive monographic book about Ronan and Erwan Bouroullec. Previously, two other monographs had been published about the Bouroullec brothers' design work: *Ronan et Erwan Bouroullec – Catalogue de Raison* (Paris: Images Modernes / kreò, 2002) and *Ronan et Erwan Bouroullec* (Paris: Phaidon Press, 2003).



Design and

Baguette is a rectangular, large table in two parts. An opaque top rests on a highly resistant yet delicate aluminium base. We focused our attention on the structure of the project to use the less aluminium material as possible. The effect is visual as it brings an additional graphical feature to the table: the heavy top is only supported by four chopstick-looking feet.

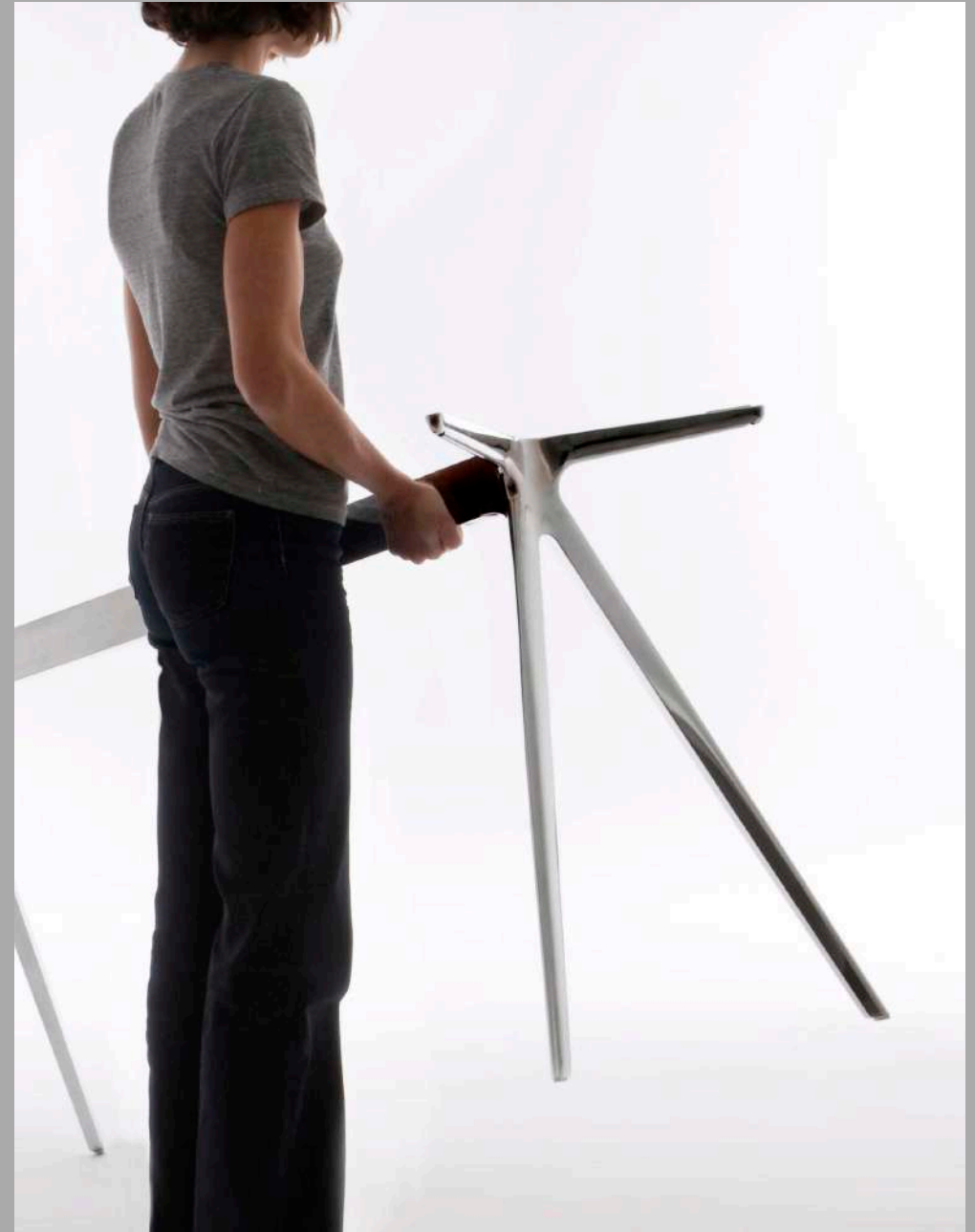

Engineering



“ The Baguette
heavy top seems
to be floating

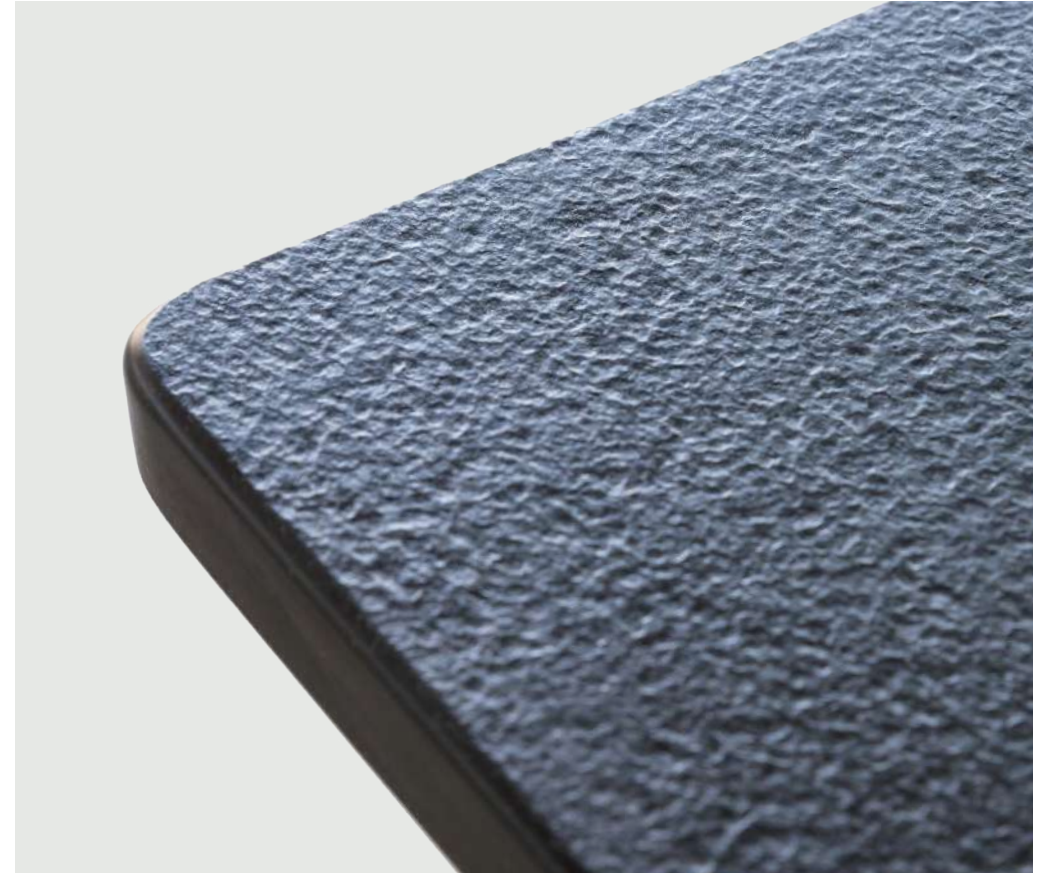

supported only
by four spindly
legs ”



Information



Product

Material: legs in die-cast aluminium polished or painted in polyester powder.
Crosspiece in aluminium polished or painted in polyester powder.
Tops in tempered glass, in Italian ardesia slate, in MDF, in American walnut, in Carrara marble or in veneered Fenix with ABS edges (only for Baguette desk version).
Versions for outdoor use also available.



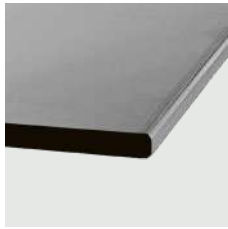

Tempered smoked glass
Indoor use

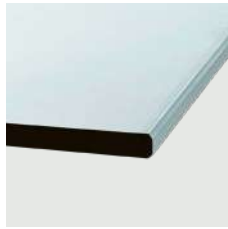

Tempered clear glass
Indoor use



MDF white 8500
Indoor use

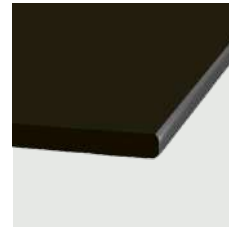

MDF black 8510
Indoor use



Solid American walnut
Indoor use



Carrara marble white
Outdoor use



Italian ardesia slate
Outdoor use



MDF veneered natural oak
Indoor use

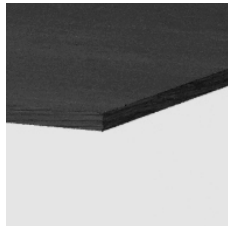

MDF veneered dark oak
Indoor use



MDF veneered oak thermo-treated
Indoor use



Beige with edge in ABS painted white
Indoor use

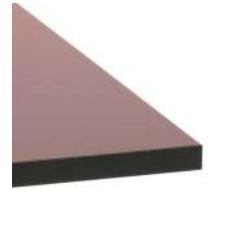

Bordeaux with edge in ABS painted black
Indoor use

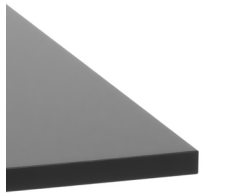

Grey with edge in ABS painted black
Indoor use

Frame in aluminium



Polished
Indoor use



White 5108
Outdoor use



Black 5140
Outdoor use

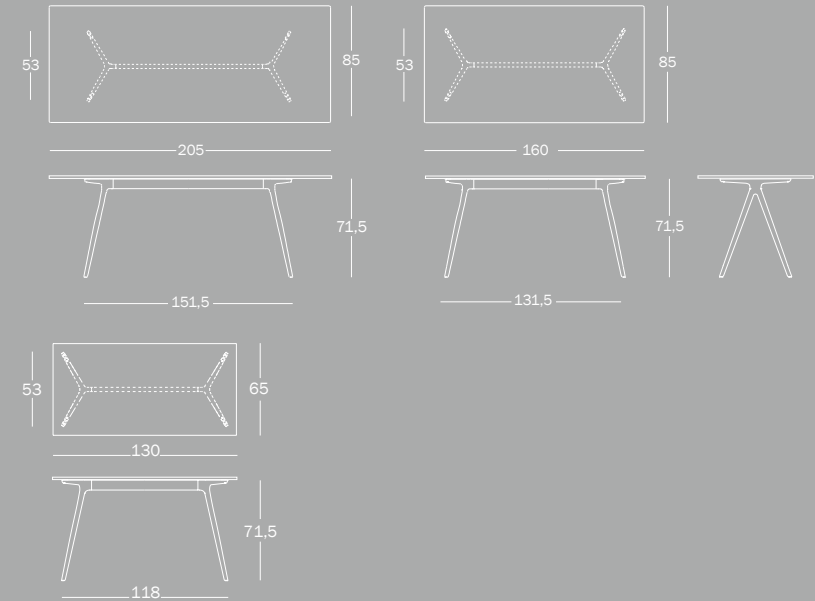

PRODUCT CARE

We recommend using a soft rag, either dry or wet. When needed, use ph-balanced soap diluted in water. Do not use abrasive sponges as they may leave scratches. Immediately dry after washing with a soft rag or chamois leather. Never leave water or other liquids to stagnate on the product. Avoid contact with all acidic substances. Small marks or irregularities, which might be visible on the surface of the polished frame, should not be considered as faults, but on the contrary, as technical results of the nature of natural aluminium and its brushing and polishing by hand. Aluminium is very likely to dull while using. We recommend using specific cleaning products for aluminium. Any marks, signs or irregularities that may be visible on the stone tops are peculiarities of the materials and should not be considered as faults. We recommend using cleaning products specific for stone materials. Remove stains immediately, as the stone used is a natural material and as such it has not been submitted to any anti-stain treatment. For tops in marble, please avoid using acid products. In case of contact of any acid substance with the marble surface, please remove it immediately. We recommend using water and Marseilles soap for marble cleaning. To remove greasy substances and various stains it is possible to use ammoniacs, denatured alcohol, bicarbonate and hydrogen peroxide. For tops in wood, we recommend using ph-balanced liquid soap especially formulated for wood, diluted in water. Regular care is therefore necessary to maintain its original appearance.

WARNING

Do not use different cleaning products from the ones mentioned above. Do not use the product in an improper way. Do not place hot objects on it, stand on it or use the product as a ladder. Once disused, please make sure that this item is disposed of in an environmentally-friendly way. Magis is not liable for any damage to property or persons caused by an improper use of this product.



